

ECOTIP

FILTRACIJA ZRAKA IN TEKOČIN
AIR AND LIQUID FILTRATION

ecofil[®]

FILTER

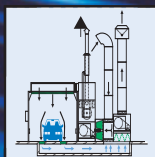
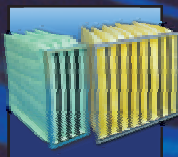
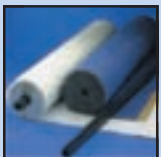

ECOTIP d.o.o. je slovensko podjetje s sedežem v Slovenskih Konjicah. Naša osnovna dejavnost je proizvodnja **ECOFIL**[®] filtrov v skladu s standardom EN 779:

- Filtrski razred G1 - G4 ... filtri za grobo filtriranje v ploščah, rolah in filter vreče;
- Filtrski razred F5 - F9 ... filtri za fino filtriranje v ploščah, rolah in filter vreče;
- V-filtri ... filtri za mikro filtracijo;
- Filtrski razred H10 - H14 in U15 - U17 ... absolutni filtri z možnostjo izbire preizkusa puščanja (Leak test) in točkovnega preizkusa (Scanning).

ECOFIL[®] filtre uporabljamo v mnogih državah sveta v različnih pogojih in za različne namene uporabe:

- **ECOFIL**[®] filtri za prezračevanje in klimatizacijo zraka v tovarnah, zgradbah, bolnišnicah, računalniških centrih, elektronski industriji ...
- **ECOFIL**[®] filtri za lakirne kabine kot predfiltri, talni filtri, stropni filtri in visoko temperaturno obstojni filtri za sušilce.
- **ECOFIL**[®] filtri za industrijsko filtracijo oz. odpravevanje (ceveni in vrečasti filtri) za različne pogoje in namene uporabe v farmacevtski industriji, cementarnah, proizvodnji apna, železarnah, jeklarnah, tovarnah aluminija, lesni industriji, tovarnah pijač in sladkorja, livarnah, sežigalnicah ...
- **ECOFIL**[®] filtri za filtracijo tekočin ... galvanizacija, prečiščevanje odpadnih voda, tovarne sladkorja in v ostalih industrijskih panogah.

ECOFIL[®] filtre proizvajamo v standardnih dimenzijah, le-te pa lahko prilagodimo vašim željam in potrebam, pri čemer vam tudi svetujemo.

S svojimi proizvodi se predstavljamo v tem katalogu z željo, da bi zadostili vašim potrebam. Z veseljem bomo odgovorili na vaša morebitna vprašanja, zato nikar ne odlašajte in stopite v stik z nami.

ECOTIP d.o.o. (Ltd.) is a Slovenian manufacturer with headquarters in Slovenske Konjice. Our main activity is production of **ECOFIL**[®] filters according to EN 779 standard as follows:

- Filter class G1-G4 ... filters for coarse filtration in pads, rolls and filtering bags.
- Filter class F5 - F9... fine filters in sheets and filtering bags.
- Rigid V filters for micro filtration.
- Filter class H10 - H14, U15 - U17... Absolute filters with leak and scan tests, on request.

ECOFIL[®] filters are used in many countries all over the world and applications are as follows:

- **ECOFIL**[®] filters for ventilation and air-conditioning in plants, buildings, hospitals, computer centers, electronic industry etc.
- **ECOFIL**[®] filters for spray booths, floor filters, ceiling filters and high temperature resistant filters for driers.
- **ECOFIL**[®] filters for industrial dust extraction (pipe filters and filtering bags) for different industrial applications such as pharmacy, cement plants, lime plants, iron and steel plants, aluminium, wood and beverage industries, sugar factories, foundries, incinerators, etc.
- **ECOFIL**[®] filters for the filtration of liquids... galvanization, waste-water treatment, sugar factories, and other areas of industry.

ECOFIL[®] filters are produced in standard dimension which can be adapted according to your individual requirements together with our advice.

Details of our products are available in this catalogue. We hope that they will meet with your approval and if you have any further questions, please do not hesitate to contact us.

ECOTIP

ECOTIP D.O.O.

Tovarniška cesta 4
SI - 3210 Slovenske Konjice
SLOVENIJA - SLOVENIA

Tel.: +386 (0)3 75 80 300
Fax: +386 (0)3 75 80 305

E-mail: ecotip@ecotip.si
<http://www.ecotip.si>

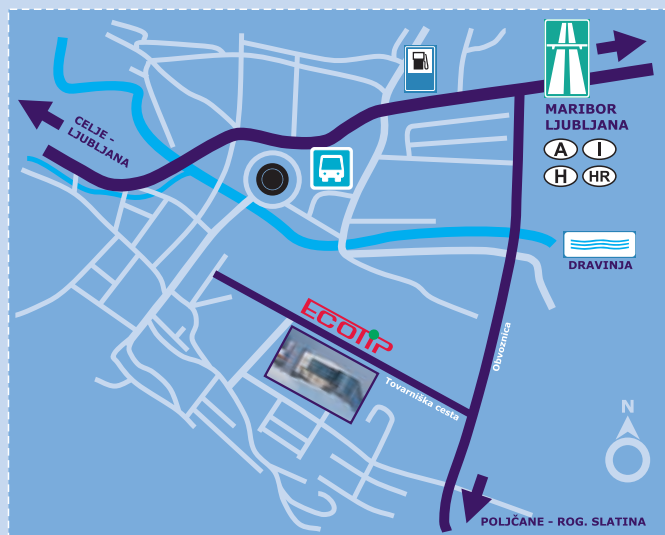

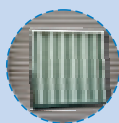

Prostorska filtracija

tabela zračnih filtrov	5
filter plošče za klimatizacijo	6
kasetni filtri za klimatizacijo	7
kasetni filtri s plastičnimi okvirji	8
tehnični podatki kasetnih filtrov	10
rol filter	19
filter vreče za klimatizacijo	19

Air filtration & climatization

.....	air filter table
.....	filter pads for climatization
.....	cassette filters for climatization
.....	fibreplast framed cassette filters
.....	technical data of cassette filters
.....	roll filters
.....	bag filters

Filtri za lakirne kabine

filtri za lakirne kabine	20
sistem uporabe filtrov za lakirne kabine	21

Spraybooth filter

.....	spraybooth filters
.....	spraybooth filter application system

Absolutni filtri - ultra filtracija

absolutni filtri - ultra filtracija	22
kompaktni filtri	24
separatorski sistem	26
mini-plisirni sistem	27

Absolute filters - ultra filtration

.....	absolute filters - ultra filtration
.....	compact filters
.....	separator system
.....	mini-pleat system

Filter vreče za industrijsko filtracijo

filter vreče za industrijsko filtracijo	28
---	----

Industrial dust collection filter bags

.....	dust collection bag filters
-------	-----------------------------

Filter patrone - vložki

filter patrone - vložki	29
-------------------------------	----

Filter cartridges

.....	cartridge filters
-------	-------------------

Industrijsko odpraševanje

tabela filtrov	30
----------------------	----

Industrial dust collections

.....	filter table
-------	--------------

Filtracija tekočin

filter patrone, vreče, membranska filtracija	33
material za filter stiskalnice	34
vakuumski filtri	35

Liquid filtration

.....	filter cartridges, bags, membrane filters
.....	filter clothes, pressure filters media
.....	vacuum filters



ecofil[®]
FILTER





tabela zračnih filtrov

table of air filters

 Način obratovanja - uporaba Operation modus - application	Filtrski razred Filter Class	Material zračnega filtra Air filter material	Nadomestilo za rol filtre Replacement of roll filters	Kasetni filtri Filter Cassettes	Vrečasti filtri Filtering bags	Enote zračnih filtrov Air filter units
	DIN 24185/EN779	role, plošče rolls, pads	vsi sistemi all systems	Za vgradnjo v stene in kanale, uporabljajo se tudi v enotah za prezračevanje. For installing into walls and channels, as well as for air handling units.		
Grobi prašni filtri za filtracijo zelo grobega prahu. Coarse dust filters for the filtration of very coarse dust.	G 1 65 %					
Predfiltri za visoke koncentracije prahu. Naprave za prezračevanje in klimatizacijo z majhnimi zahtevami glede kvalitete zraka. Prezračevanje hal, na primer v jekelnah in železarnah. Pre-filters for high dust concentrations. Ventilators and air-conditioners with low requirements for air quality. Ventilation of large industrial areas, for example in the iron and steel industry.	G 2 80 %	0514				
Predfiltri za prezračevanje in klimatizacijo zraka. Filtri za prezračevanje tovarn v procesni industriji, na primer za prezračevanje prostorov, v katerih so motorji, ali za zaščito strojev. Predfiltri za zaščito visokozmogljivih filtrskih naprav. Pre-filters for ventilation and air conditioning. Filters for ventilation of plants in the processing industry, for example, ventilating engine rooms or to protect machines. Pre-filters for protection of high-capacity filtering devices.	G 3 90 %	2020B	Sintetika Synthetics 1521R	Kasetni filtri – 30 Cassette filters – 30	FV-30	Pleated 30
Filtri za ločevanje finega prahu pri prezračevalnih napravah ter predfiltri in končni filtri na industrijskem in komercialnem področju, kjer je zahtevana visoka stopnja čistosti zraka. Veleblagovnice, restavracije, zbornice, prezračevanje prostorov, kjer je nameščena občutljiva tehnologija, klinike, sprejemni prostori v bolnišnicah, predfiltri za višjo kvaliteto zraka. Filters for separating fine dust in air handling units as pre- and final filters in industrial and commercial fields, where a high purity of air is required. Department stores, restaurants, assembly rooms, ventilation of rooms containing sensitive technology, medical clinics, hospital wards, pre-filters for higher quality of air.	G 4 ≥40 %	1525 2040	Sintetika Synthetics 1525	Kasetni filtri – 40 Cassette filters – 40	FV-40	Pleated 40
Filtri za ločevanje finega prahu pri visoko kvalitetnih napravah za prezračevanje in klimatizacijo, na primer v industriji računalniške opreme, farmacevtski in fotografski industriji, pri obdelavi občutljivih površin v avtomobilski industriji, bolnišničnih sobah in laboratorijih. Filters for separation of fine dust in high quality air ventilation and air conditioning units, for example, in the computer industry, pharmaceutical and photographic industries, surface-finishing technology in the automobile industry, hospital rooms, and laboratories.	F 5 60 %	2025M CC600G-10 VA600G-10		Kasetni filtri – 50 Cassette filters – 50	FV-50 FV-50K	Pleated 50
Filtri za ločevanje finega prahu pri visoko kvalitetnih napravah za prezračevanje in klimatizacijo, na primer v industriji računalniške opreme, farmacevtski in fotografski industriji, pri obdelavi občutljivih površin v avtomobilski industriji, bolnišničnih sobah in laboratorijih. Filters for separation of fine dust in high quality air ventilation and air conditioning units, for example, in the computer industry, pharmaceutical and photographic industries, surface-finishing technology in the automobile industry, hospital rooms, and laboratories.	F 6 80 %	F 65			FV-70	V-filtri V-filters
Fini filtri v sistemih s čistim zrakom, kjer veljajo zelo visoke zahteve po čistosti zraka, filtri za zaščito visoko kvalitetne strojne opreme, na primer v montažnih halah, prostorih z občutljivimi mehanizmi, pri proizvodnji hrane, predfiltri za absolutne filtre, brezhibno čiste sobe, na primer v farmacevtski industriji, v proizvodnji mikročipov in v operacijskih sobah. Fine filters in systems with clean air and requiring extremely high air purity, filters for the protection of high quality machines, for example, in assembly rooms, rooms with sensitive equipment, in food processing, pre-filters for absolute filters, sterile rooms, for example, in the pharmaceutical industry, in the production of microchips and hospital operating theatres.	F 7 90 %	F 85			FV-85	V-filtri V-filters
	F 8 95 %	F 90				
	F 9	F 95			FV-95	V-filtri V-filters

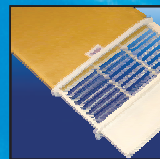
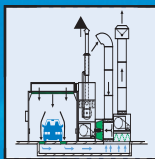
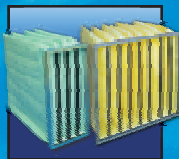
Tip / Type	0514	2020B	1525	2040	2025M
Filtrski razred Filter class DIN 24 185/EN 779.....	G 2	G 3	G 4	G 4	F 5
Material Material	Sintetika Synthetics	Sintetika Synthetics		Sintetika Synthetics	
Pralno Washable	Da Yes	Da Yes		Ne No	
					
Oblika proizvoda Product form	Rola / plošča Roll / pad	Rola / plošča Roll / pad		Rola / plošča Roll / pad	
	Sintetični termično spojeni vlaknasti flis, samougasljiv v skladu z DIN 53 438, razred F1. Synthetic thermally bonded fibre fleece, self-extinguishing according to DIN 53 438, class F1.	Progressivno strukturiran material, narejen iz termično spojenih sintetičnih vlaken. Samougasljiv v skladu z DIN 53 438, razred F1. Progressively structured material, made of thermally bonded synthetic fibres. Self-extinguishing according to DIN 53 438, class F1.		Večslojni material iz sintetičnih vlaken spremenljive gostote, termično spojen in laminiran. Razporeditev vodi k razvrstitvi prahu po celotni globinski sestavi. Samougasljiv v skladu z DIN 53 438, razred F1. Multi-layer of synthetic fibres of varying density that are thermally bonded and laminated. The arrangement leads to grading of dust all over the depth structure. Self-extinguishing according to DIN 53 438, class F1.	
Tehnični podatki o filtrih v skladu z DIN 24 185/EN779					
Samougasljiv v skladu z DIN 53 438, razred F1. Self-extinguishing according to DIN 53 438, class F1.					
Nominalni volumen zraka [m³/h]	5400	5.400	3.600	2.520	2.520
Nominal air volume					
Povprečno zadrževanje prahu [%]	72	88,10	91,80	94	97,80
Average dust arresting					
Povprečna učinkovitost prašnih delcev [%]	–	–	–	–	53,20
Average dust particle efficiency					
Začetni padec tlaka [Pa]	13	35	46	60	38
Initial pressure drop					
Priporočeni končni padec tlaka [Pa]	250	250	250	250	450
Recommended final pressure drop					
Temperatura obratovanja [°C]	100	100	100	100	100
Operational temperature					
Globina [mm]	5	20	12	20	12
Depth					

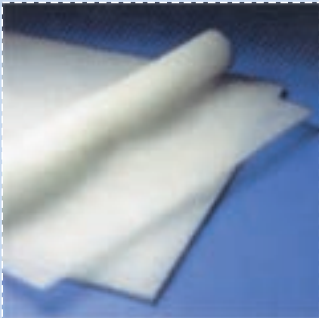
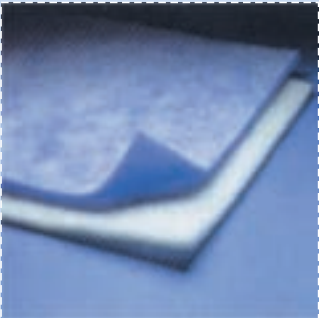
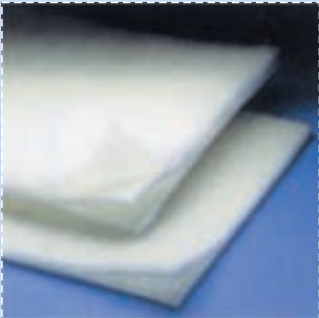
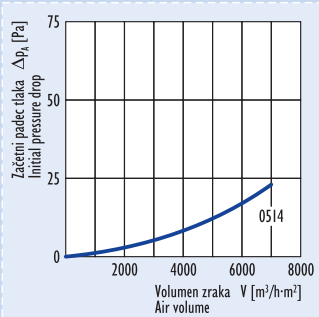
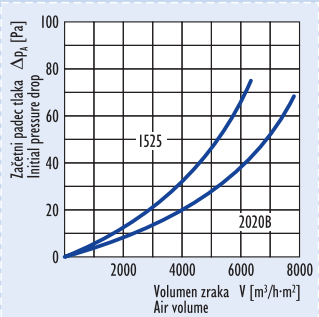
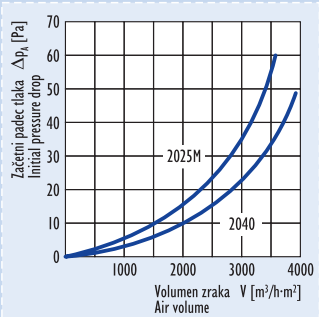
Kasetni Cassette filter

30R



To so ploščate filter kasete iz filter materiala, debeline 12 mm. Običajno se uporabljajo za prezračevalne naprave v standardnih debelinah 11,20 in 25 mm.
Flat filter plate cassettes made of filter material, 12 mm thick. They are usually used in air conditioning units at standard thickness of 11.20 and 25 mm.

Samougasljiv v skladu z DIN 53 438, razred F1.
Self-extinguishing according to DIN 53 438, class F1.

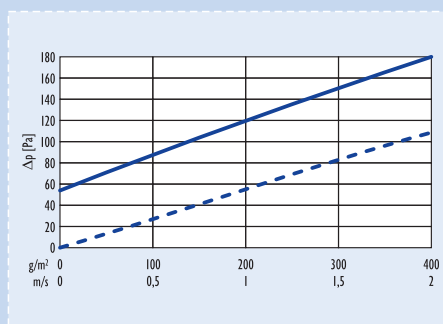

Razred Class G 3

Kasetni Cassette filter

30

40



Plisirana različica filtra, narejena iz "Ecofil 1525". Specialna guba daje tej celici visoko propustnost zraka in večjo kapaciteto zadrževanja prahu kot pri ravni izvedbi. Prodajajo se v različnih velikostih - standardnih debeline 48 mm in 98 mm.

Pleated version of a filter, made of "Ecofil 1525". Special pleating ensures this cell has a high air-flow rate and a greater dust holding capacity than the flat version. It is sold in different sizes - in standard thicknesses of 48 and 98 mm.

Samougasljiv v skladu z DIN 53 438, razred F1.
Self-extinguishing according to DIN 53 438, class F1.

Pretok na filtrsko enoto Air flow [m ³ /h]								
Hitrost zraka Air velocity	1 m/s		1,5 m/s		2 m/s		2,5 m/s	
Dimenzije Dimensions	h=50; h=100	h=50; h=100	h=50; h=100	h=50; h=100	h=50; h=100	h=50; h=100	h=50; h=100	h=50; h=100
287×592	950	1150	1400	1700	1900	2300	2400	2900
490×592	1600	2000	2450	2950	3250	3950	4050	4900
592×592	1950	2400	2950	3550	3900	4750	4950	5900
287×287	450	600	700	850	950	1150	1250	1450
Δp [Pa]	23		39		62		95	

Razred Class G 3

Kasetni Cassette filter

50R

50

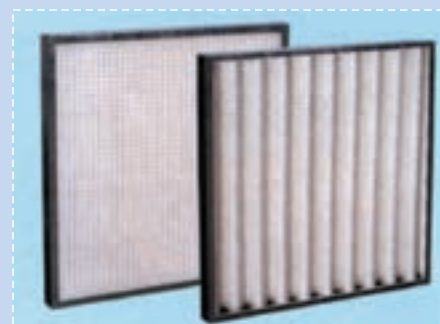

Filter kasete so narejene iz visoko učinkovitega filtra v razredu F5. V zahtevni predfiltraciji jih uporabljamo v ravni ali plisirani različici. Prodajajo se v standardnih in nestandardnih velikostih in v različnih debelinah.

Filter cells are made of high efficiency medium in F5 classes. In demanding preliminary filtration they are used in either the flat version, or in the pleated version. They are sold in standard and non-standard sizes, and in various thicknesses.

Samougasljiv v skladu z DIN 53 438, razred F1.
Self-extinguishing according to DIN 53 438, class F1.

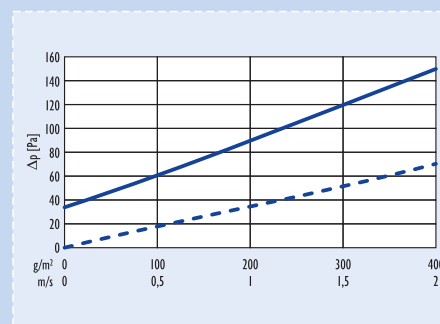

Razred Class F 5

Okvir Frame		Kovinski Metallic	Kovinski Metallic	Kovinski Metallic	Kovinski Metallic	Kovinski Metallic
Tip medija Medium type		1525	1525	1525	2025M	2025M
Zadrževanje Arresting	[%]	87,50	87,50	93	96	96
Učinkovitost Efficiency	[%]				48	48
Hitrost Velocity	m/s	1,50	1,50	1,50	1,50	1,50
Δ padec tlaka Δ Pressure drop	Pa	25	31	35	55	49
T max T max	°C	100	100	100	100	100

.....funktionalnost in kakovost **functionality & quality**

ECOTIP Ecofil® kasetni filtri, v filtrskih razredih G4-F9 / EN 779, s pomočjo večslojnih vlaknastih flisov zagotavljajo učinkovito čiščenje zraka z majhnimi tlačnimi razlikami. Nov tip okvirja iz fiberplasta omogoča dobro tesnjenje filtra, visoko obstojnost, natančnost in ekološko odstranjevanje ostankov s sežiganjem.

ECOTIP Ecofil® filter cells in the filter classes G4-F9/ EN 779 guarantee effective air filtration and low pressure differences with the aid of a multilayer synthetic micro spunbond. This new type of frame made of fibreplast enables a good sealing of the filter medium, high stiffness, and dimensional stability, as well as the possibility of burning with no residue.

Visoka kakovost izdelave

ECOFIL® kasetni filtri so odporni proti vlagi, odbijajo vodo in so mikrobiološko inertni. Uporaba sintetičnih materialov v skladu z zahtevami VDI 6022 omogoča higiensko neoporečno obratovanje filtra. ECOFIL® filter cells are resistant to humidity, waterproof and microbiologically inert. The application of synthetic materials in compliance with VDI 6022 enables a perfect, hygienic filter operation.

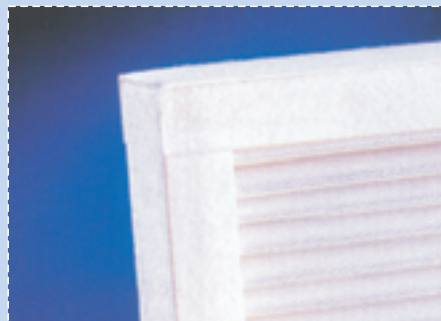

Standard izdelave filtrov zagotavlja natančnost, pravokotnost in aerodinamičnost. Preskus gorljivosti po DIN 53438 je filter uvrstil v razred vnetljivosti F1, kar pomeni, da se »samodejno ugasne« in tako zagotavlja varno in zanesljivo obratovanje. The standard of filter processing assures the dimensional stability, perpendicularity, and aerodynamic contours. The inflammability test in compliance with DIN 53438 ranked the filter in the fire classification F1, meaning that it is »self-extinguishing« and, as a such, safe and reliable for its operation.

High production processing standard



Okvir klasičnih filtrov je običajno narejen iz kartona, občutljivega na vlago, z visoko stopnjo prepuščanja zraka in odstopajočimi merami, kar onemogoča neoporečno delovanje filtra. The frames of the conventional filters are often made of short-lasting cardboard, sensitive to humidity, with a high air-leak rate and unstable dimensions, which prevent a perfect hygienic filter operation.

Minimalne tlačne razlike

ECOTIP Ecofil® kasetni filtri imajo trikrat večjo površino kot običajni. Zaradi tega so hitrosti skozi filtrski medij nižje, tlačne razlike pa manjše. Stroški energije so tako bistveno nižji. The surface of ECOTIP Ecofil® filter cells is triple that of the ordinary ones. It causes lower filter medium velocity, and smaller pressure differences. The energy costs are, therefore, essentially lower.

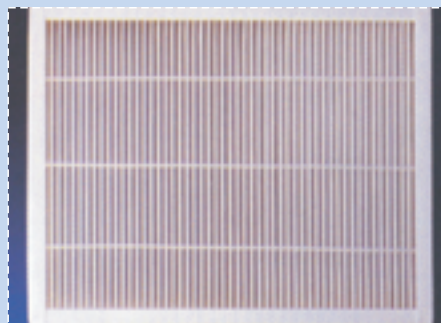

Optimirane razdalje med pliseji omogočajo enakomeren pretok in maksimalno izrabo filtra. Zaradi tega je življenjska doba daljša, obratovalni stroški pa so minimalni. Optimized distances between pleatings enable constant airflow and maximal filter utilization. In this regard the life expectancy is longer, and the operational costs are minimal.

Minimal pressure differences

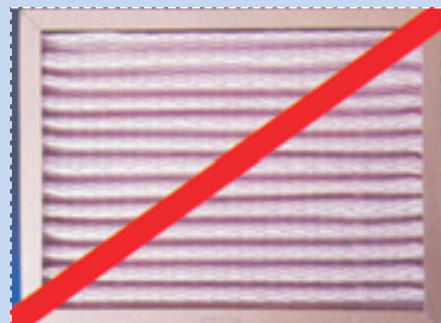

V nasprotju z optimirano razdaljo med pliseji so široki in neenakomerni pliseji, ki močno zmanjšajo površino filtra. Za te filtre so značilni visoki obratovalni stroški in kratka življenjska doba. Wide and uneven pleatings strongly reduce the surface of the filter. High operational costs and short life expectancy are typical of these filters.

filtri s plastičnimi okvirji fibreplast framed filters

ecofil®
FILTER

funkcionalnost in kakovost functionality & quality.....

Visoka varnost filtra

High filter safety

Zaradi uporabe tako imenovanega hot-melt lepljenja, ki ne prepušča delcev, je tesnost med filtrskim medijem in okvirjem maksimalna. To omogoča čiščenje zraka tudi na robnem predelu filtra.

The use of hot-melt adhesion prevents particles flowing through and means maximal tightness between the filter medium and the frame. It enables air to also flow through the edges of the filter.



Oblika dela filtra, vpetega v okvir, onemogoča prepuščanje delcev. To zagotavlja visoko varnost filtra do filtrskega razreda F9/EN 779. The enframed filter part ensures that particles cannot get through, thus assuring high security to the classification F9/ EN 779.



Robni del običajnih filtrov je velikokrat samo prepognjen. Visoka stopnja prepuščanja onemogoča uporabo nad filtrskim razredom G4 / EN 779. The edges of common filters are very often only folded down. A high degree of leakage prevents use above filter classification G4/ EN 779.

Optimirana geometrija plisejev

Optimized geometry of the pleating system

Bistveni prednosti ECOTIP Ecofil® kasetnih filtrov sta enakomernost in dostopnost do filtrskega medija. Pliseji, položeni v obliki črke V, omogočajo maksimalen globinski učinek.

The essential advantages of the ECOTIP ECOFIL® filter cells are uniformity, and accessibility to the filter medium. Pleatings in V form enable maximal deep action.



Novi hot-melt postopek fiksiranja plisejev omogoča popolno izrabo filtrskega medija ob ugodnem diferenčnem tlaku in ugodni življenjski dobi filtra.

A new hot-melt procedure for fixing the pleatings enables a full consumption of the filter medium to best advantage regarding differential pressure, and life expectancy of the filter.

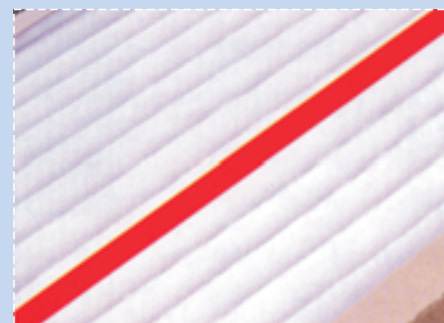

Velike razdalje med pliseji in okrogle zunanje konture: zračni tok komaj doseže dno pliseja. Zaradi tega se na površini začne nabirati prah, življenjska doba je krajša. The long distances between pleatings and round outer contours means that airflow hardly reaches the bottom part of the pleating. It causes dust together and a shorter life expectancy of the filter.

Maksimalna skladnost z okoljem

Maximal enviromental compatibility

Vse komponente ECOFIL® filtra so izdelane iz kombinacije čistega poliestra in poliolefina. Filtrski mediji so brez veziv, topil ali barvil.

All components of the ECOFIL® filter are made of a combination of pure polyester and polyolefine. Filter media are free of fixing agents, solvents or colouring agents.

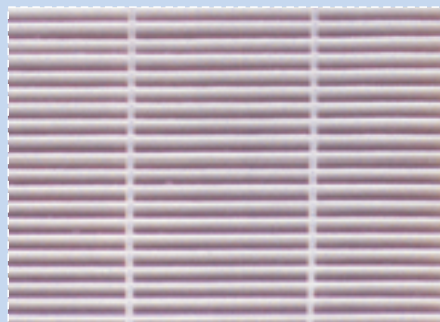

Pri izdelavi filtrov se ne uporabljajo kovinski delci ali steklena vlakna, temveč samo čisti organski polimeri v skladu z VDI 6022.

No metal particles or glass fibres but only pure organic polymers in compliance with VDI 6022 are used for filter production.

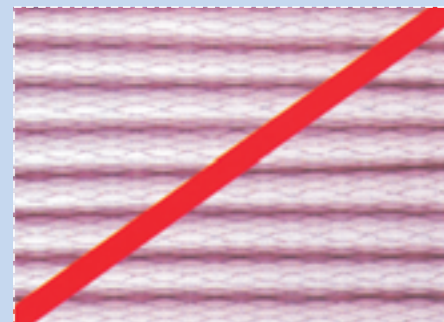

Za stabilizacijo se pogosto uporabljajo kovinska veziva ali mrežice, ki povečujejo prostornino in težo filtrov. Po preteku njihove življenjske dobe otežujejo zbiranje odpadkov. Metal fixing agents and meshes are often used for filter production. This causes greater filter volume and weight and becomes difficult when the filters are gathered as waste after their life expectancy expires.

Opis

- Panelni filter ECOFIL® z gosto plisiranim filtrskim medijem, izdelan iz sintetične mikro preje
- Možnost recikliranja s sežiganjem in možnost izvedbe brez kovin
- Nov sistem plisiranja ECOTIP® z načinom vročega spajanja za izvedbo z nizkim začetnim uporom
- Posebna konstrukcija z okvirjem iz lepenke, kovine ali lesa in dodatno ojačitvijo

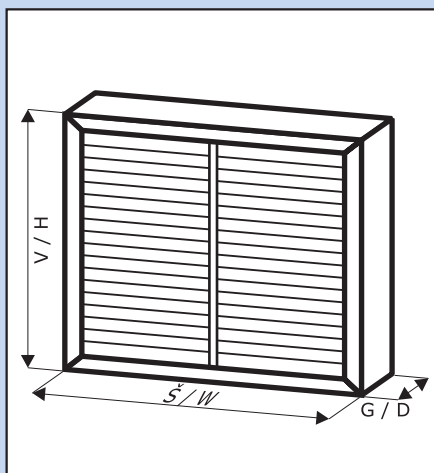

Description

- ECOFIL® Panel Filter with closely pleated filter media made of synthetic micro spun bond
- Recycling by ashing possible, metal free design possible
- New ECOFIL® pleating system using hot-melt traces for low resistance performance
- Special designs with cardboard, metal, or wooden frame and additional special reinforcing as well

Tip Type	Velikost [S×V×G] Size [W×H×D]	Površina Filter area	Območje nominalnega pretoka zraka Range of nominal airflow (100 - 125 %)
R20 495 394	495×394×20	1,00 m ²	1760-2190 m ³ /h
R20 495 495	495×495×20	1,15 m ²	2200-2750 m ³ /h
R20 592 592	592×592×20	1,44 m ²	3200-4000 m ³ /h
R20 622 394	622×394×20	1,00 m ²	2200-2750 m ³ /h
R20 622 495	622×495×20	1,09 m ²	2800-3500 m ³ /h

Dobava mogoča v različnih velikostih / With different sizes available

Tehnični podatki

Technical data

Filtrirni razred / Filter Class	DIN EN 779	G 4	F 5
Povprečna stopnja filtracije (sint. prah) / Average arrestance (synth. dust)	DIN EN 779	94 %	95 %
Povprečna učinkovitost (atm. prah) / Average efficiency (atm. dust)	DIN EN 779	37 %	45 %
Padec tlaka pri 100 % nominalnem pretoku zraka / Pressure drop at 100 % nominal airflow			
Začetni / Initial	Pa	70	80
Končni (priporočeno) / Final (recommended)	Pa	250	450
Število slojev / Number of layers			
	-	1	1
Maks. obratovalna temperatura / Max. operation temperature			
	°C	80	80
Maks. obratovalna vlažnost (rel. vlaga) / Max. operation moisture (rel. humidity)			
	%	100	100
Vnetljivost / Inflammability			
	DIN 53438	F1	F1

Tehnični podatki so bili zbrani po naših najboljših močeh. Odgovornosti za podatke ne sprejemamo. Pridržujemo si pravico do tehničnih sprememb. Technical data are being compiled to the best of our knowledge. Responsibility cannot be accepted. We reserve the right of technical modifications.

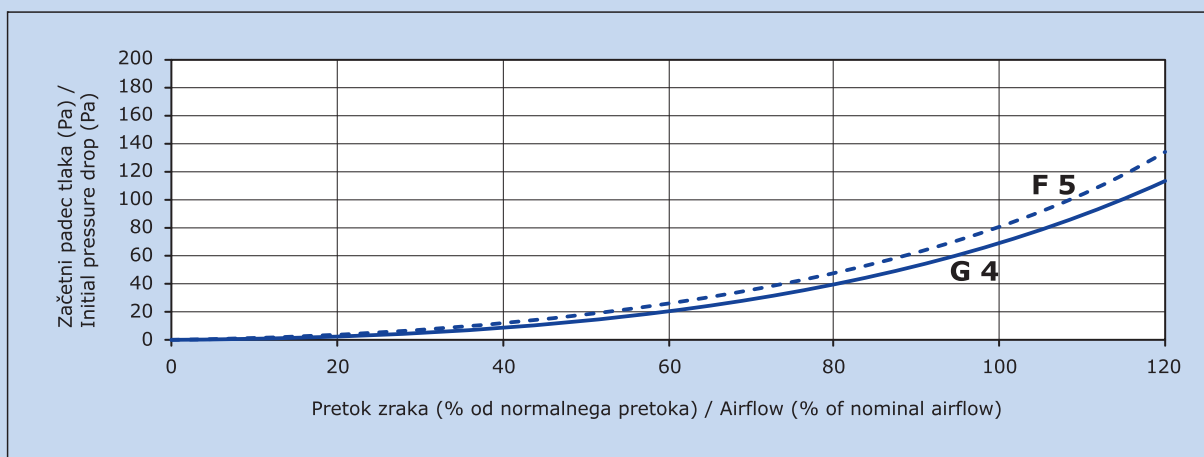

ECOTIP d.o.o., Tovarniška cesta 4, SI-3210 Slovenske Konjice, Slovenija / Slovenia
 Tel.: +386 (0)3 75 80 300, Fax: +386 (0)3 75 80 305
 E-mail: ecotip@ecotip.si, Web: www.ecotip.si

Opis

- Panelni filter ECOFIL® z gosto plisiranim filtrskim medijem, izdelan iz sintetične mikro preje
- Možnost recikliranja s sežiganjem in možnost izvedbe brez kovin
- Nov sistem plisiranja ECOTIP® z načinom vročega spajanja za izvedbo z nizkim začetnim uporom
- Posebna konstrukcija z okvirjem iz lepenke, kovine ali lesa in dodatno ojačitvijo

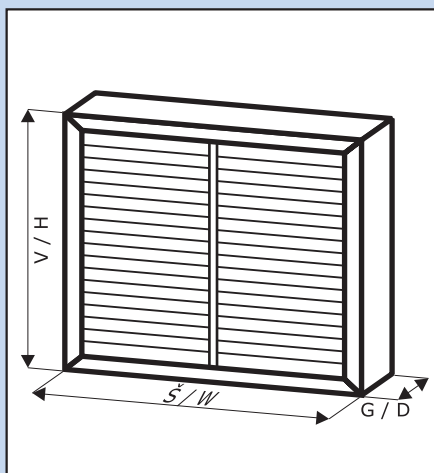

Description

- ECOFIL® Panel Filter with closely pleated filter media made of synthetic micro spun bond
- Recycling by ashing possible, metal free design possible
- New ECOFIL® pleating system using hot-melt traces for low resistance performance
- Special designs with cardboard, metal, or wooden frame and additional special reinforcing as well

Tip Type	Velikost [S×V×G] Size [W×H×D]	Površina Filter area	Območje nominalnega pretoka zraka Range of nominal airflow (100 – 125 %)
R20 495 394	495×394×20	1,00 m ²	1760–2190 m ³ /h
R20 495 495	495×495×20	1,15 m ²	2200–2750 m ³ /h
R20 592 592	592×592×20	1,44 m ²	3200–4000 m ³ /h
R20 622 394	622×394×20	1,00 m ²	2200–2750 m ³ /h
R20 622 495	622×495×20	1,09 m ²	2800–3500 m ³ /h

Dobava mogoča v različnih velikostih / With different sizes available

Tehnični podatki

Technical data

Filtrirni razred / Filter Class	DIN EN 779	F 6	F 7	F 8
Povprečna stopnja filtracije (sint. prah) / Average arrestance (synth. dust)	DIN EN 779	95 %	>98 %	>99 %
Povprečna učinkovitost (atm. prah) / Average efficiency (atm. dust)	DIN EN 779	65 %	85 %	95 %
Padec tlaka pri 100 % nominalnem pretoku zraka / Pressure drop at 100 % nominal airflow				
Začetni / Initial	Pa	90	120	140
Končni (priporočeno) / Final (recommended)	Pa	450	450	450
Število slojev / Number of layers	-	1	1	1
Maks. obratovalna temperatura / Max. operation temperature	°C	80	80	80
Maks. obratovalna vlažnost (rel. vlaga) / Max. operation moisture (rel. humidity)	%	100	100	100
Vnetljivost / Inflammability	DIN 53438	F1	F1	F1

Tehnični podatki so bili zbrani po naših najboljših močeh. Odgovornosti za podatke ne sprejemamo. Pridržujemo si pravico do tehničnih sprememb. Technical data are being compiled to the best of our knowledge. Responsibility cannot be accepted. We reserve the right of technical modifications.

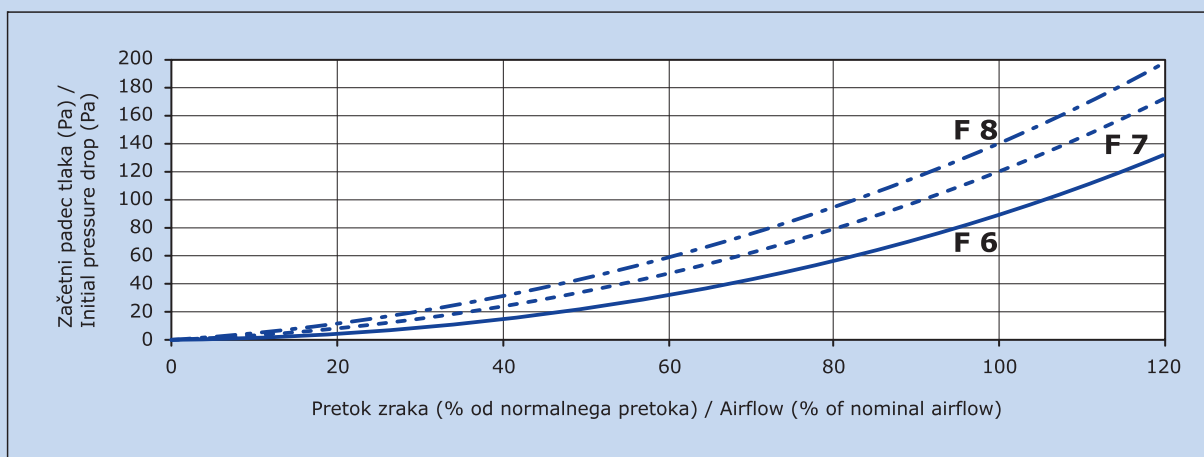

Opis

- Panelni filter ECOFIL® z gosto plisiranim filtrskim medijem, izdelan iz sintetične mikro preje
- Možnost recikliranja s sežiganjem in možnost izvedbe brez kovin
- Nov sistem plisiranja ECOTIP® z načinom vročega spajanja za izvedbo z nizkim začetnim uporom
- Posebna konstrukcija z okvirjem iz lepenke, kovine ali lesa in dodatno ojačitvijo

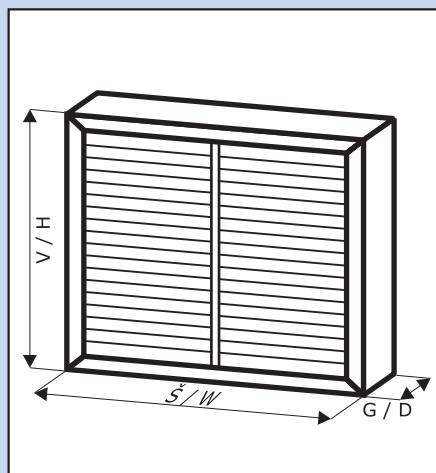

Description

- ECOFIL® Panel Filter with closely pleated filter media made of synthetic micro spun bond
- Recycling by ashing possible, metal free design possible
- New ECOFIL® pleating system using hot-melt traces for low resistance performance
- Special designs with cardboard, metal, or wooden frame and additional special reinforcing as well

Tip Type	Velikost [S×V×G] Size [W×H×D]	Površina Filter area	Območje nominalnega pretoka zraka Range of nominal airflow (100 – 125 %)
R25 495 394	495×394×25	1,10 m ²	1760–2190 m ³ /h
R25 495 495	495×495×25	1,26 m ²	2200–2750 m ³ /h
R25 592 592	592×592×25	1,80 m ²	3200–4000 m ³ /h
R25 622 394	622×394×25	1,30 m ²	2200–2750 m ³ /h
R25 622 495	622×495×25	1,60 m ²	2800–3500 m ³ /h

Dobava mogoča v različnih velikostih / With different sizes available

Tehnični podatki

Technical data

Filtrirni razred / Filter Class	DIN EN 779	G 4	F 5
Povprečna stopnja filtracije (sint. prah) / Average arrestance (synth. dust)	DIN EN 779	94 %	95 %
Povprečna učinkovitost (atm. prah) / Average efficiency (atm. dust)	DIN EN 779	37 %	45 %
Padec tlaka pri 100 % nominalnem pretoku zraka / Pressure drop at 100 % nominal airflow			
Začetni / Initial	Pa	70	80
Končni (priporočeno) / Final (recommended)	Pa	250	450
Število slojev / Number of layers			
	-	1	1
Maks. obratovalna temperatura / Max. operation temperature			
	°C	80	80
Maks. obratovalna vlažnost (rel. vlaga) / Max. operation moisture (rel. humidity)			
	%	100	100
Vnetljivost / Inflammability			
	DIN 53438	F1	F1

Tehnični podatki so bili zbrani po naših najboljših močeh. Odgovornosti za podatke ne sprejemamo. Pridržujemo si pravico do tehničnih sprememb. Technical data are being compiled to the best of our knowledge. Responsibility cannot be accepted. We reserve the right of technical modifications.

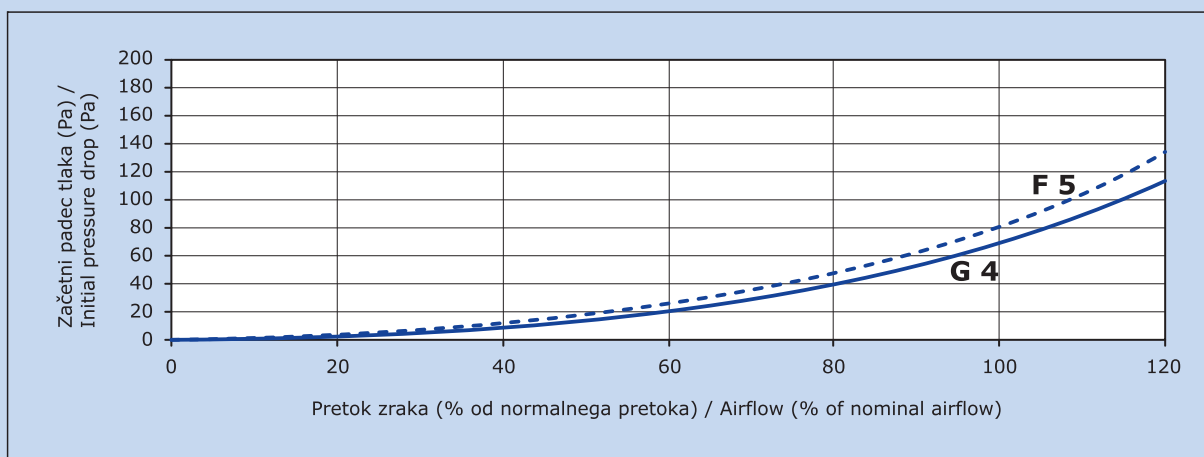

Opis

- Panelni filter ECOFIL® z gosto plisiranim filtrskim medijem, izdelan iz sintetične mikro preje
- Možnost recikliranja s sežiganjem in možnost izvedbe brez kovin
- Nov sistem plisiranja ECOTIP® z načinom vročega spajanja za izvedbo z nizkim začetnim uporom
- Posebna konstrukcija z okvirjem iz lepenke, kovine ali lesa in dodatno ojačitvijo

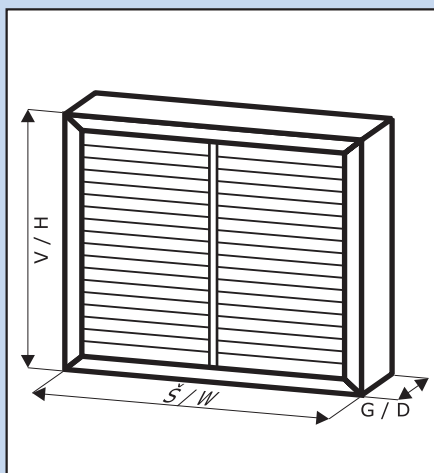

Description

- ECOFIL® Panel Filter with closely pleated filter media made of synthetic micro spun bond
- Recycling by ashing possible, metal free design possible
- New ECOFIL® pleating system using hot-melt traces for low resistance performance
- Special designs with cardboard, metal, or wooden frame and additional special reinforcing as well

Tip Type	Velikost [S×V×G] Size [W×H×D]	Površina Filter area	Območje nominalnega pretoka zraka Range of nominal airflow (100 – 125 %)
R25 495 394	495×394×25	1,10 m ²	1760–2190 m ³ /h
R25 495 495	495×495×25	1,26 m ²	2200–2750 m ³ /h
R25 592 592	592×592×25	1,80 m ²	3200–4000 m ³ /h
R25 622 394	622×394×25	1,30 m ²	2200–2750 m ³ /h
R25 622 495	622×495×25	1,60 m ²	2800–3500 m ³ /h

Dobava mogoča v različnih velikostih / With different sizes available

Tehnični podatki

Technical data

Filtrirni razred / Filter Class	DIN EN 779	F 6	F 7	F 8
Povprečna stopnja filtracije (sint. prah) / Average arrestance (synth. dust)	DIN EN 779	>95 %	>98 %	>99 %
Povprečna učinkovitost (atm. prah) / Average efficiency (atm. dust)	DIN EN 779	65 %	85 %	95 %
Padec tlaka pri 100 % nominalnem pretoku zraka / Pressure drop at 100 % nominal airflow				
Začetni / Initial	Pa	90	110	125
Končni (priporočeno) / Final (recommended)	Pa	450	450	450
Število slojev / Number of layers				
		1	1	1
Maks. obratovalna temperatura / Max. operation temperature				
	°C	80	80	80
Maks. obratovalna vlažnost (rel. vlaga) / Max. operation moisture (rel. humidity)				
	%	100	100	100
Vnetljivost / Inflammability				
	DIN 53438	F1	F1	F1

Tehnični podatki so bili zbrani po naših najboljših močeh. Odgovornosti za podatke ne sprejemamo. Pridržujemo si pravico do tehničnih sprememb. Technical data are being compiled to the best of our knowledge. Responsibility cannot be accepted. We reserve the right of technical modifications.

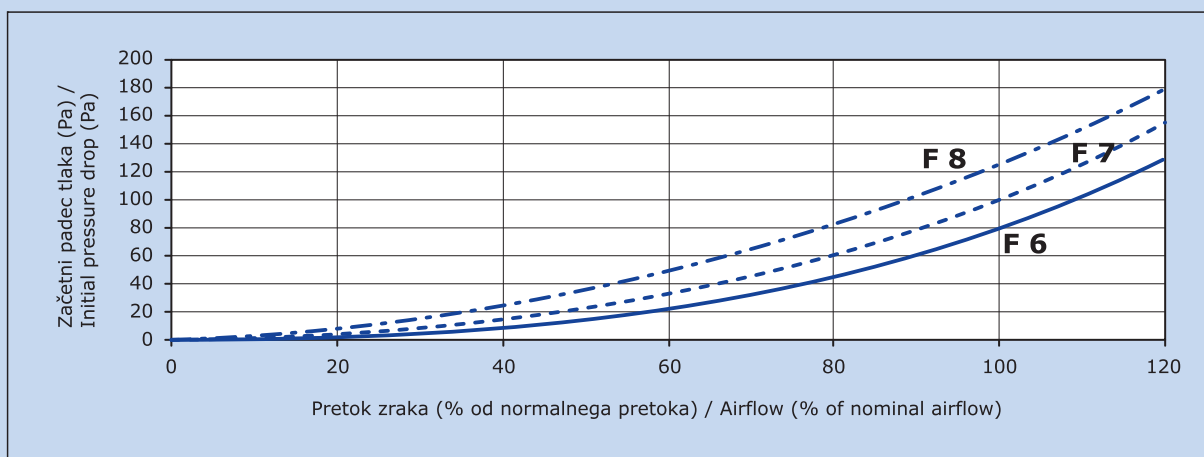

Opis

- Panelni filter ECOFIL® z gosto plisiranim filtrskim medijem, izdelan iz sintetične mikro preje
- Možnost recikliranja s sežiganjem in možnost izvedbe brez kovin
- Nov sistem plisiranja ECOTIP® z načinom vročega spajanja za izvedbo z nizkim začetnim uporom
- Posebna konstrukcija z okvirjem iz lepenke, kovine ali lesa in dodatno ojačitvijo

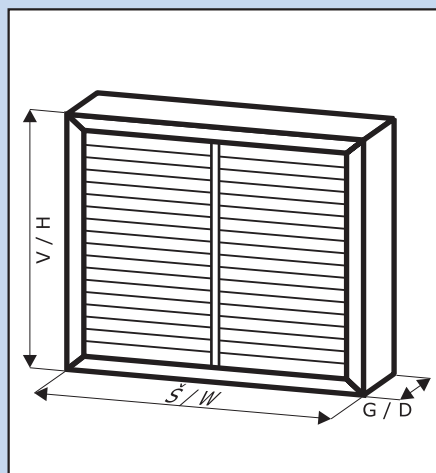

Description

- ECOFIL® Panel Filter with closely pleated filter media made of synthetic micro spun bond
- Recycling by ashing possible, metal free design possible
- New ECOFIL® pleating system using hot-melt traces for low resistance performance
- Special designs with cardboard, metal, or wooden frame and additional special reinforcing as well

Tip Type	Velikost [S×V×G] Size [W×H×D]	Površina Filter area	Območje nominalnega pretoka zraka Range of nominal airflow (100 – 125 %)
R48 495 394	495×394×48	1,86 m ²	1760-2190 m ³ /h
R48 495 495	495×495×48	2,34 m ²	2200-2750 m ³ /h
R48 592 592	592×592×48	3,39 m ²	3200-4000 m ³ /h
R48 622 394	622×394×48	2,34 m ²	2200-2750 m ³ /h
R48 622 495	622×495×48	2,94 m ²	2800-3500 m ³ /h

Dobava mogoča v različnih velikostih / With different sizes available

Tehnični podatki

Technical data

Filtrirni razred / Filter Class	DIN EN 779	G 4	F 5
Povprečna stopnja filtracije (sint. prah) / Average arrestance (synth. dust)	DIN EN 779	94 %	95 %
Povprečna učinkovitost (atm. prah) / Average efficiency (atm. dust)	DIN EN 779	37 %	45 %
Padec tlaka pri 100 % nominalnem pretoku zraka / Pressure drop at 100 % nominal airflow			
Začetni / Initial	Pa	50	55
Končni (priporočeno) / Final (recommended)	Pa	250	450
Število slojev / Number of layers			
	-	1	1
Maks. obratovalna temperatura / Max. operation temperature			
	°C	80	80
Maks. obratovalna vlažnost (rel. vlaga) / Max. operation moisture (rel. humidity)			
	%	100	100
Vnetljivost / Inflammability			
	DIN 53438	F1	F1

Tehnični podatki so bili zbrani po naših najboljših močeh. Odgovornosti za podatke ne sprejemamo. Pridržujemo si pravico do tehničnih sprememb. Technical data are being compiled to the best of our knowledge. Responsibility cannot be accepted. We reserve the right of technical modifications.

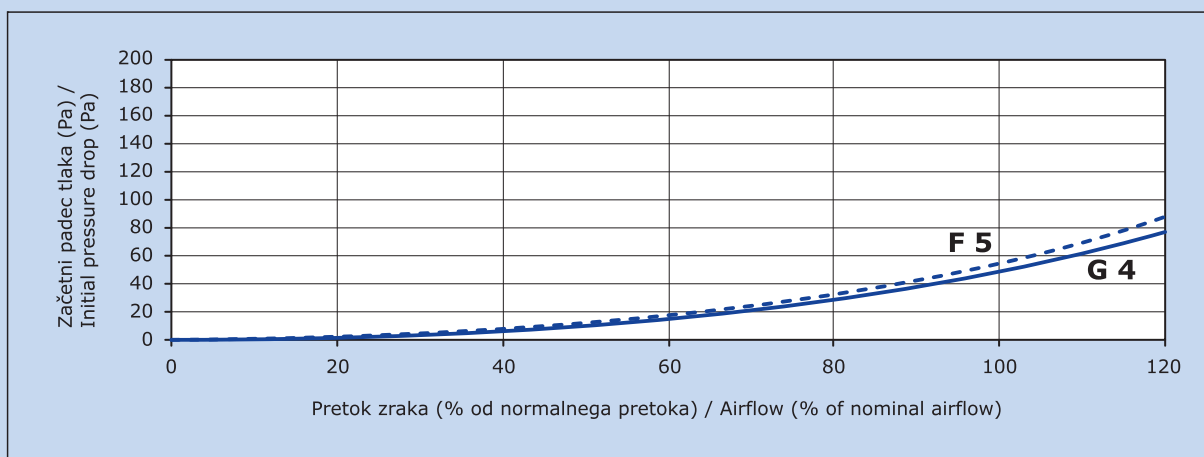

ECOTIP d.o.o., Tovarniška cesta 4, SI-3210 Slovenske Konjice, Slovenija / Slovenia
 Tel.: +386 (0)3 75 80 300, Fax: +386 (0)3 75 80 305
 E-mail: ecotip@ecotip.si, Web: www.ecotip.si

Opis

- Panelni filter ECOFIL® z gosto plisiranim filtrskim medijem, izdelan iz sintetične mikro preje
- Možnost recikliranja s sežiganjem in možnost izvedbe brez kovin
- Nov sistem plisiranja ECOTIP® z načinom vročega spajanja za izvedbo z nizkim začetnim uporom
- Posebna konstrukcija z okvirjem iz lepenke, kovine ali lesa in dodatno ojačitvijo

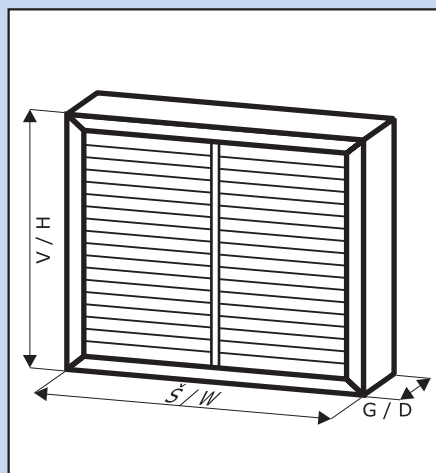

Description

- ECOFIL® Panel Filter with closely pleated filter media made of synthetic micro spun bond
- Recycling by ashing possible, metal free design possible
- New ECOFIL® pleating system using hot-melt traces for low resistance performance
- Special designs with cardboard, metal, or wooden frame and additional special reinforcing as well

Tip Type	Velikost [S×V×G] Size [W×H×D]	Površina Filter area	Območje nominalnega pretoka zraka Range of nominal airflow (100 – 125 %)
R48 495 394	495×394×48	1,86 m ²	1760-2190 m ³ /h
R48 495 495	495×495×48	2,34 m ²	2200-2750 m ³ /h
R48 592 592	592×592×48	3,39 m ²	3200-4000 m ³ /h
R48 622 394	622×394×48	2,34 m ²	2200-2750 m ³ /h
R48 622 495	622×495×48	2,94 m ²	2800-3500 m ³ /h

Dobava mogoča v različnih velikostih / With different sizes available

Tehnični podatki

Technical data

Filtrirni razred / Filter Class	DIN EN 779	F 6	F 7	F 8
Povprečna stopnja filtracije (sint. prah) / Average arrestance (synth. dust)	DIN EN 779	95 %	>98 %	>99 %
Povprečna učinkovitost (atm. prah) / Average efficiency (atm. dust)	DIN EN 779	65 %	85 %	95 %
Padec tlaka pri 100 % nominalnem pretoku zraka / Pressure drop at 100 % nominal airflow				
Začetni / Initial	Pa	60	80	100
Končni (priporočeno) / Final (recommended)	Pa	450	450	450
Število slojev / Number of layers	-	1	1	1
Maks. obratovalna temperatura / Max. operation temperature	°C	80	80	80
Maks. obratovalna vlažnost (rel. vlaga) / Max. operation moisture (rel. humidity)	%	100	100	100
Vnetljivost / Inflammability	DIN 53438	F1	F1	F1

Tehnični podatki so bili zbrani po naših najboljših močeh. Odgovornosti za podatke ne sprejemamo. Pridržujemo si pravico do tehničnih sprememb. Technical data are being compiled to the best of our knowledge. Responsibility cannot be accepted. We reserve the right of technical modifications.

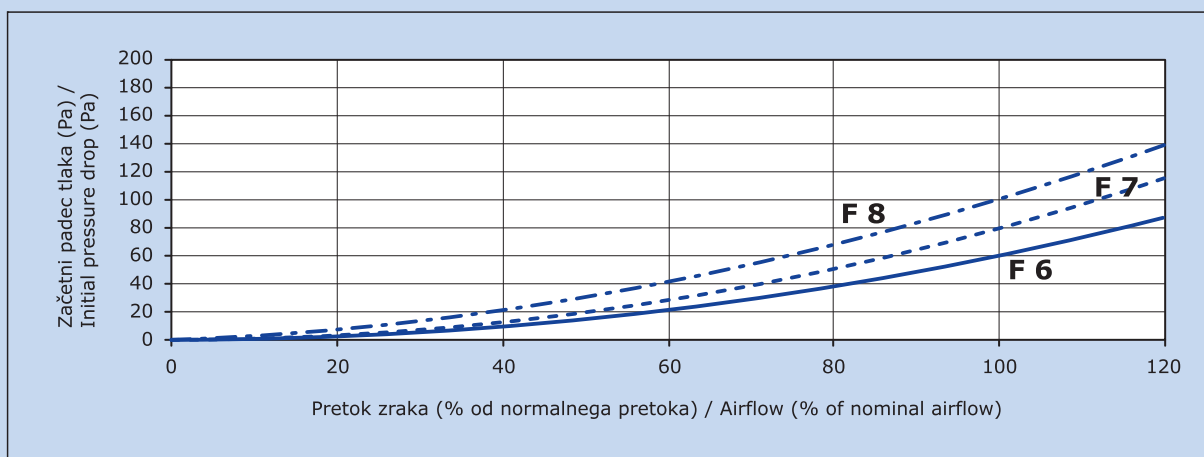

Opis

- Panelni filter ECOFIL® z gosto plisiranim filtrskim medijem, izdelan iz sintetične mikro preje
- Možnost recikliranja s sežiganjem in možnost izvedbe brez kovin
- Nov sistem plisiranja ECOTIP® z načinom vročega spajanja za izvedbo z nizkim začetnim uporom
- Posebna konstrukcija z okvirjem iz lepenke, kovine ali lesa in dodatno ojačitvijo

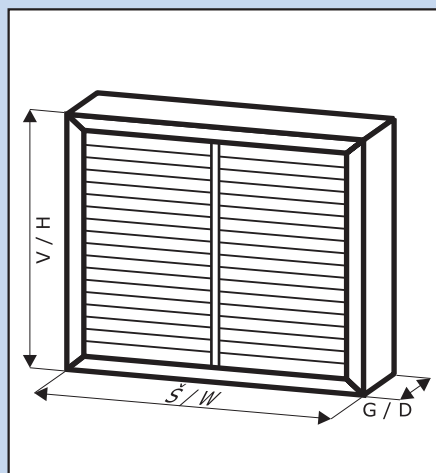

Description

- ECOFIL® Panel Filter with closely pleated filter media made of synthetic micro spun bond
- Recycling by ashing possible, metal free design possible
- New ECOFIL® pleating system using hot-melt traces for low resistance performance
- Special designs with cardboard, metal, or wooden frame and additional special reinforcing as well

Tip Type	Velikost [S×V×G] Size [W×H×D]	Površina Filter area	Območje nominalnega pretoka zraka Range of nominal airflow (100 – 125 %)
R98 495 394	495×394×98	2,57 m ²	1760-2190 m ³ /h
R98 495 495	495×495×98	3,14 m ²	2200-2750 m ³ /h
R98 592 592	592×592×98	4,36 m ²	3200-4000 m ³ /h
R98 622 394	622×394×98	3,03 m ²	2200-2750 m ³ /h
R98 622 495	622×495×98	3,74 m ²	2800-3500 m ³ /h

Dobava mogoča v različnih velikostih / With different sizes available

Tehnični podatki

Technical data

Filtrirni razred / Filter Class	DIN EN 779	G 4	F 5
Povprečna stopnja filtracije (sint. prah) / Average arrestance (synth. dust)	DIN EN 779	94 %	95 %
Povprečna učinkovitost (atm. prah) / Average efficiency (atm. dust)	DIN EN 779	37 %	45 %
Padec tlaka pri 100 % nominalnem pretoku zraka / Pressure drop at 100 % nominal airflow			
Začetni / Initial	Pa	45	50
Končni (priporočeno) / Final (recommended)	Pa	250	450
Število slojev / Number of layers			
	-	1	1
Maks. obratovalna temperatura / Max. operation temperature			
	°C	80	80
Maks. obratovalna vlažnost (rel. vlaga) / Max. operation moisture (rel. humidity)			
	%	100	100
Vnetljivost / Inflammability			
	DIN 53438	F1	F1

Tehnični podatki so bili zbrani po naših najboljših močeh. Odgovornosti za podatke ne sprejemamo. Pridržujemo si pravico do tehničnih sprememb. Technical data are being compiled to the best of our knowledge. Responsibility cannot be accepted. We reserve the right of technical modifications.

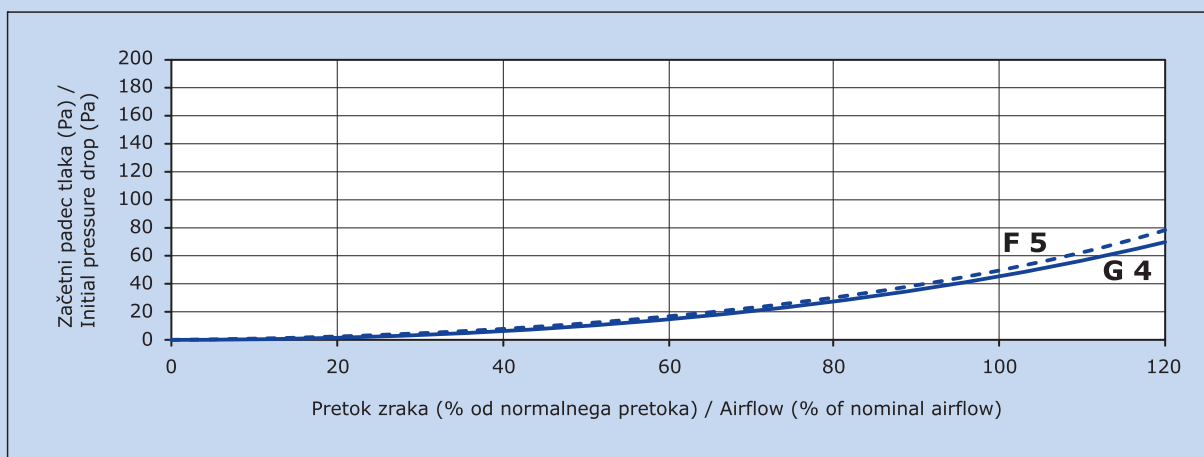

ECOTIP d.o.o., Tovarniška cesta 4, SI-3210 Slovenske Konjice, Slovenija / Slovenia
 Tel.: +386 (0)3 75 80 300, Fax: +386 (0)3 75 80 305
 E-mail: ecotip@ecotip.si, Web: www.ecotip.si

Opis

- Panelni filter ECOFIL® z gosto plisiranim filtrskim medijem, izdelan iz sintetične mikro preje
- Možnost recikliranja s sežiganjem in možnost izvedbe brez kovin
- Nov sistem plisiranja ECOTIP® z načinom vročega spajanja za izvedbo z nizkim začetnim uporom
- Posebna konstrukcija z okvirjem iz lepenke, kovine ali lesa in dodatno ojačitvijo

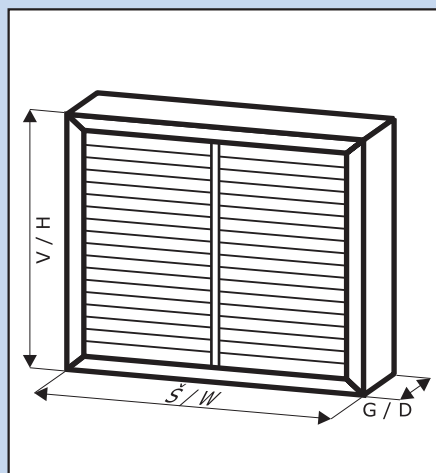

Description

- ECOFIL® Panel Filter with closely pleated filter media made of synthetic micro spun bond
- Recycling by ashing possible, metal free design possible
- New ECOFIL® pleating system using hot-melt traces for low resistance performance
- Special designs with cardboard, metal, or wooden frame and additional special reinforcing as well

Tip Type	Velikost [S×V×G] Size [W×H×D]	Površina Filter area	Območje nominalnega pretoka zraka Range of nominal airflow (100 – 125 %)
R98 495 394	495×394×98	2,57 m ²	1760-2190 m ³ /h
R98 495 495	495×495×98	3,14 m ²	2200-2750 m ³ /h
R98 592 592	592×592×98	4,36 m ²	3200-4000 m ³ /h
R98 622 394	622×394×98	3,03 m ²	2200-2750 m ³ /h
R98 622 495	622×495×98	3,74 m ²	2800-3500 m ³ /h

Dobava mogoča v različnih velikostih / With different sizes available

Tehnični podatki

Technical data

Filtrirni razred / Filter Class	DIN EN 779	F 6	F 7	F 8
Povprečna stopnja filtracije (sint. prah) / Average arrestance (synth. dust)	DIN EN 779	94 %	>95 %	>99 %
Povprečna učinkovitost (atm. prah) / Average efficiency (atm. dust)	DIN EN 779	65 %	85 %	95 %
Padec tlaka pri 100 % nominalnem pretoku zraka / Pressure drop at 100 % nominal airflow				
Začetni / Initial	Pa	55	70	80
Končni (priporočeno) / Final (recommended)	Pa	450	450	450
Število slojev / Number of layers				
		2	2	2
Maks. obratovalna temperatura / Max. operation temperature				
	°C	80	80	80
Maks. obratovalna vlažnost (rel. vlaga) / Max. operation moisture (rel. humidity)				
	%	100	100	100
Vnetljivost / Inflammability				
	DIN 53438	F1	F1	F1

Tehnični podatki so bili zbrani po naših najboljših močeh. Odgovornosti za podatke ne sprejemamo. Pridržujemo si pravico do tehničnih sprememb. Technical data are being compiled to the best of our knowledge. Responsibility cannot be accepted. We reserve the right of technical modifications.

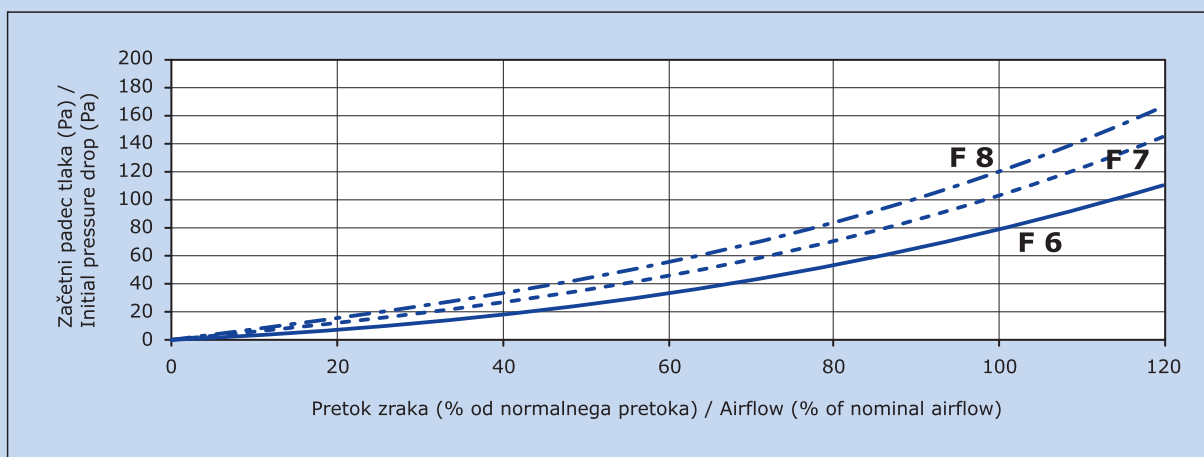

Opis

- Večslojni kovinski varjeni ECOFIL® panelni filter
- Obojestranska ekspanzirana kovinska mreža
- Obnovljiv, pralen
- GA ali ALU z galvaniziranim ECOFIL® kovinskim okvirjem in aluminijastim večslojnim polnilom
- INO ali INOX z ECOFIL® INOX okvirjem in nerjavečim večslojnim polnilom

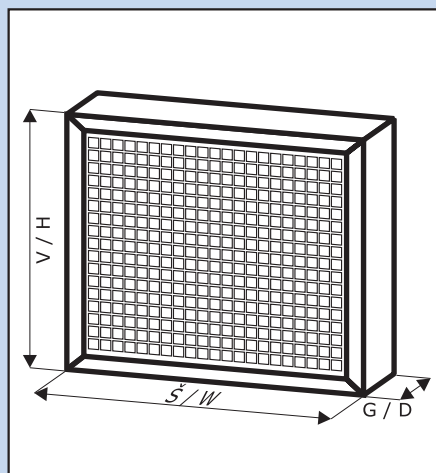

Description

- ECOFIL® Panel Filter with welded metal multi layers
- Expanded metal screen on both sides
- Regenerable
- GA or ALU with galvanized ECOFIL® steel frame and aluminium multi layers
- INO or INOX with ECOFIL® steel frame and stainless steel multi layers

Tip Type	Velikost [S×V×G] Size [W×H×D]	Filtrirni razred Filter class	Območje nominalnega pretoka zraka Range of nominal airflow (100 – 125 %)
GA/ALU 20 592 592 INO/INOX 20 592 592	592×592×20	G 2	1900-2400 m³/h
GA/ALU 25 592 592 INO/INOX 25 592 592	592×592×25	G 2	1900-2400 m³/h
GA/ALU 48 592 592 INO/INOX 48 592 592	592×592×48	G 3	1900-2400 m³/h

Dobava mogoča v različnih velikostih / With different sizes available

Tehnični podatki

Technical data

		20	25	48
Filtrirni razred / Filter Class	DIN EN 779	G 2	G 2	G 3
Povprečna stopnja filtracije (sint. prah) / Average arrestance (synth. dust)	DIN EN 779	65 %	70 %	80 %
Povprečna učinkovitost (atm. prah) / Average efficiency (atm. dust)	DIN EN 779	-	-	-
Padec tlaka pri 100 % nominalnem pretoku zraka / Pressure drop at 100 % nominal airflow				
Začetni / Initial	Pa	10	15	30
Končni (priporočeno) / Final (recommended)	Pa	400	400	400
Globina filtra / Depths od filter	mm	20	25	48
Maks. obratovalna temperatura / Max. operation temperature	°C	400	400	400
Maks. obratovalna vlažnost (rel. vlaga) / Max. operation moisture (rel. humidity)	%	100	100	100
Vnetljivost / Inflammability	DIN 53438	F1	F1	F1

Tehnični podatki so bili zbrani po naših najboljših močeh. Odgovornosti za podatke ne sprejemamo. Pridržujemo si pravico do tehničnih sprememb. Technical data are being compiled to the best of our knowledge. Responsibility cannot be accepted. We reserve the right of technical modifications.

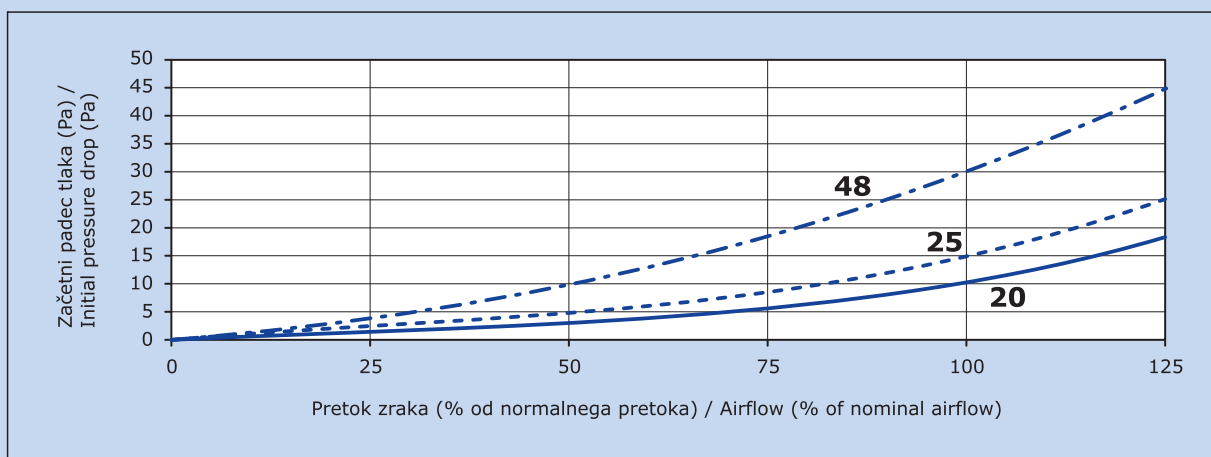

Rol filter Roll filter

G 3 **G 4**
Sintetika / naravna vlakna
Synthetics / Natural fibre
Ne No



Rola / plošča
Roll / Pad

Vlaknasti flis iz sintetike in naravnih vlaken ter s kaširano, neraztegljivo mrežico. Brez lepljive snovi za zadrževanje prahu. Samougasljiv v skladu z DIN 53 438, razred F1/K1.

Fibre fleece made from synthetic fibres, natural fibres and a stiff, non-expanding mesh. Without adhesive trapping the dust. Self-extinguishing according to DIN 53 438, class F1/K1.

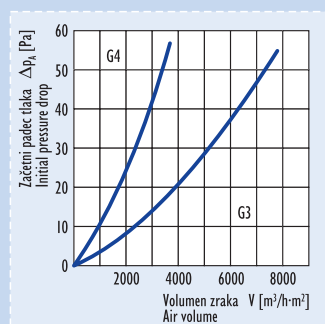

7.200 3.600

85 90

- -

50 60

250 250

80 80

10 10

Tip / Type

Filtrski razred Filter class
DIN 24 185/EN 779
Material Material
Pralno Washable

Oblika proizvoda
Product form

Tehnični podatki o filterih v skladu z
DIN 24 185/EN779
Technical data according to
DIN 24 185/EN779

Samougasljiv v skladu z
DIN 53 438, razred F1.
Self-extinguishing according
to DIN 53 438, class F1.

Nominalni volumen zraka [m³/h]
Nominal Air Volume

Povprečno zadrževanje prahu [%]
Average dust arresting

Povprečna učinkovitost prašnih delcev [%]
Average dust particle efficiency

Začetni padec tlaka [Pa]
Initial pressure drop

Priporočeni končni padec tlaka [Pa]
Recommended final pressure drop

Temperatura obratovanja [°C]
Operational temperature

Globina [mm]
Depth

Filter vreče

G 3 **G 4** **F 5**
Sintetika Synthetics
Ne No

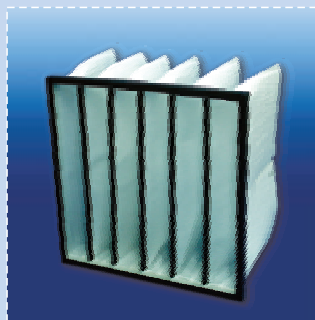

Vrečasti filtri
Filtering bags

Filtri so narejeni iz sintetičnih vlaken, oblikovanih v filter vreče, ki so zrakotesno montirane v okvir iz galvanizirane kovine. Koničasta oblika zagotavlja visoko zmogljivost vreči pri zadrževanju prahu.

Filters are made from synthetic fibres, formed into filtering bags, mounted air-tight into a frame made of galvanized metal. The tapered design guarantees a high dust holding capacity of the bags.

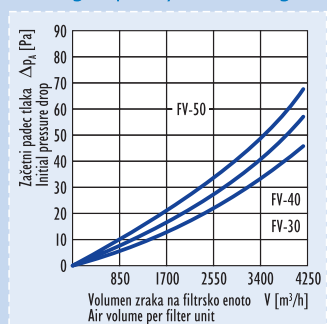

3.400 3.400 3.400

89,20 93 96

- - 60,10

30 40 60

250 250 450

100 100 100

360 360 600

Filtering bags

F 6 **F 7** **F 8/9**
Sintetika Synthetics
Ne No

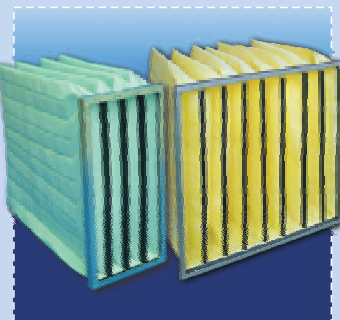

Vrečasti filtri
Filtering bags

Filtri iz sintetičnih vlaken v obliki posebno oblikovanih koničastih vreč, omogočajo enakomeren pretok zraka. Vreče so nepropustno montirane v okvir iz galvanizirane kovine brez uporabe lepila.

Filters made from synthetic fibres and specially designed tapered bags allow smooth air flow. The bags are mounted air-tight into a frame made of galvanized metal, without using glue.

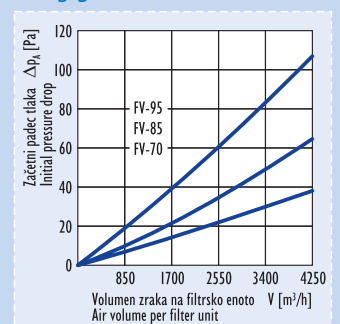

3.400 3.400 3.400

98 >98,10 >99

77,20 86 92,10

68 83 86

450 450 450

80 80 80

600 600 600

Tip / Type

Filtrski razred **Filter class**
DIN 24 185/EN 779.....

Material **Material**

Pralno **Washable**

Oblika proizvoda
Product form

Tehnični podatki o filtrih v
skladu z
DIN 24 185/EN779
**Technical data according to
DIN 24 185/EN779**

CC600G-10

VA600G-10

F 5 F 5

Sintetika **Synthetic**

Ne No Ne No

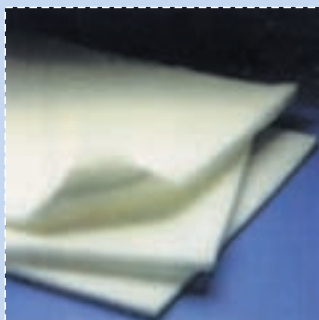

Rola / plošča
Roll / pad

Termično spojena sintetična vlakna s progresivno labirintno strukturo. Material filtrov CC600G-10 in VA600G-10 je prepojen z lepljivo snovjo za zadrževanje prahu. Samougasljiv / DIN 53 438, razred F1.

Thermally bonded synthetic fibres with progressive labyrinth structure. The filter material CC600G-10 and VA600G-10 is soaked with a dust-trapping adhesive. Self-extinguishing according to DIN 53 438, class F1.

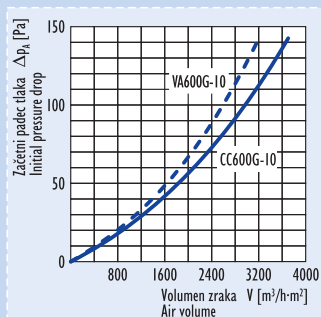

FST-80

G 2

Steklena vlakna
Glass fibre

Ne No

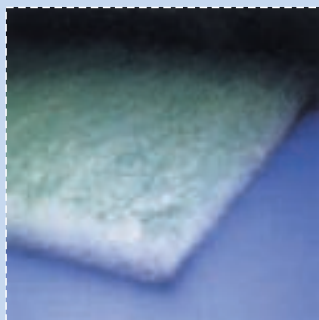

Rola / plošča
Roll / pad

Progressivno strukturiran material, narejen iz termično spojenih sintetičnih vlaken. Samougasljiv v skladu z DIN 53 438, razred F1.

Progressively structured material made of thermally bonded synthetic fibres. Self-extinguishing according to DIN 53 438, class F1.

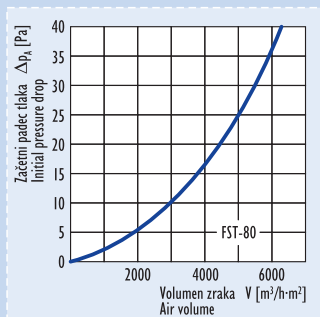

UG-300

G 4 F 5

Steklena vlakna
Glass fibre

Ne No

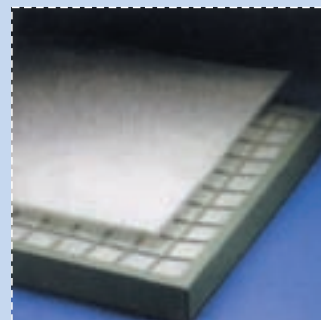

Kaseta
Cassette

Filtrske plasti, ki so sestavljene iz čvrsto vezanih vlaken. Temperaturno obstojna filtrska plast UG-300, s širokim okvirjem iz aluminija na obeh straneh.

Filter layers made of firmly bonded fibres. The temperature-resistant filter layer UG-300 framed by a wide strip of aluminium metal on both sides.

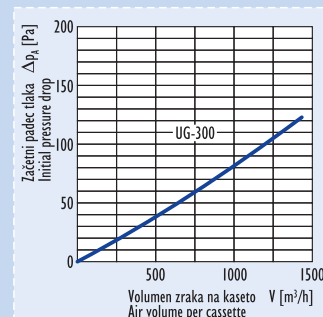

Nominalni volumen zraka Nominal air volume [m³/h]	1.000	1.000	8.000–10.000	1.000	1.000
Povprečno zadrževanje prahu Average dust arresting [%]	>97,80	97,50	93–97 velja za razpršen barvni prah refer to sprayed paint mist	93	96
Povprečna učinkovitost prašnih delcev Average dust particle efficiency [%]	50	56,36	–	–	55
Začetni padec tlaka Initial pressure drop [Pa]	23	25	25	70	85
Priporočeni končni padec tlaka Recommended final pressure drop [Pa]	450	450	250	250	450
Temperatura obratovanja Operational temperature [°C]	100	100	150	300	300
Globina Depth [mm]	20	22	80	14	48

filtri za lakirne kabine filters for spray booths

ecofil®
FILTER

..... sistem uporabe filtrov filter application system

Stropni filter CC600G-10

Stropni filter je impregniran s posebno lepljivo tekočino in se uporablja kot stropni filter za pretok zraka od zgoraj navzdol v lakirni kabini.



Ceiling filter CC600G-10

Ceiling filter is impregnated with a special adhesive liquid and is used as a ceiling filter for air flow from top to bottom in a spray booth.

Paintstop is designed exclusively for retention of superfluous paint - solid paint particles in spray booths. It is made from continuous filament glass fibre with open-weave pattern.

Paintstop roll filter FST-80



Talni filter FST-80

Talni filter je oblikovan izključno za zadrževanje odvečne razpršene barve - trdnih delcev v lakirni kabini. Izdelan je iz neprekinjenih filamentnih vlaken s progresivno netkano strukturo.

ecofil®

Material za filtre je proizveden iz toplotno spojenih poliestrskih vlaken s specifično progresivno labirintno strukturo.

Filter material is made from thermally bonded polyester fibres with a specific progressive labyrinth structure.

Vrečasti in kasetni filtri

Vrečasti in kasetni filtri se dobavljajo v različni izvedbi in kakovosti filtracije, filtrirni razred G2-G4 in F5-F9 (FN 779).



Filtering bags & Cassettes

Filtering bags and cassette filters are delivered in different sizes and filtration quality, filter classes G2-G4 and F5-F9 (FN 779).

Filter materials for preliminary filtration are delivered in different dimensions or filter pads, having a progressive labyrinth structure.

Pre-filter



Predfilter

Filter materiali za predfiltracijo se dobavljajo v različnih dimenzijah ali filter ploščah, ki imajo progresivno labirintno strukturo.

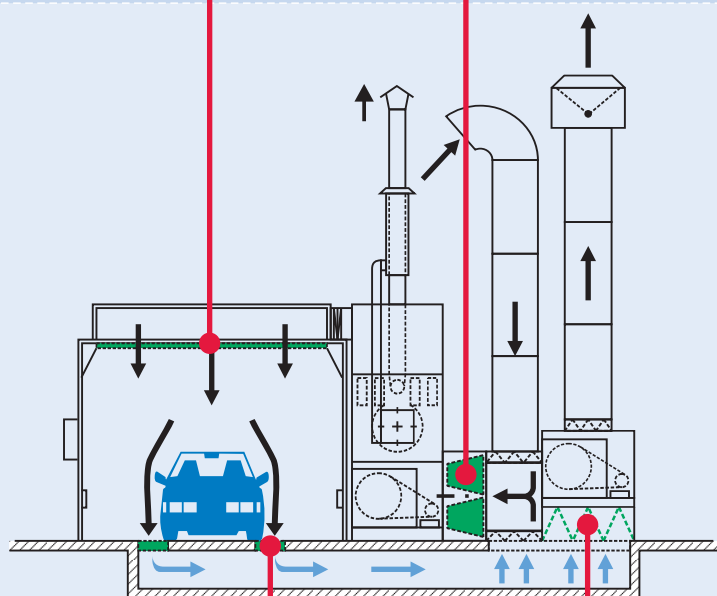

ecofil®

ecofil[®]

FILTER

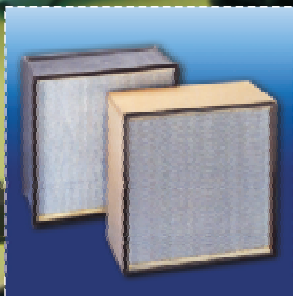
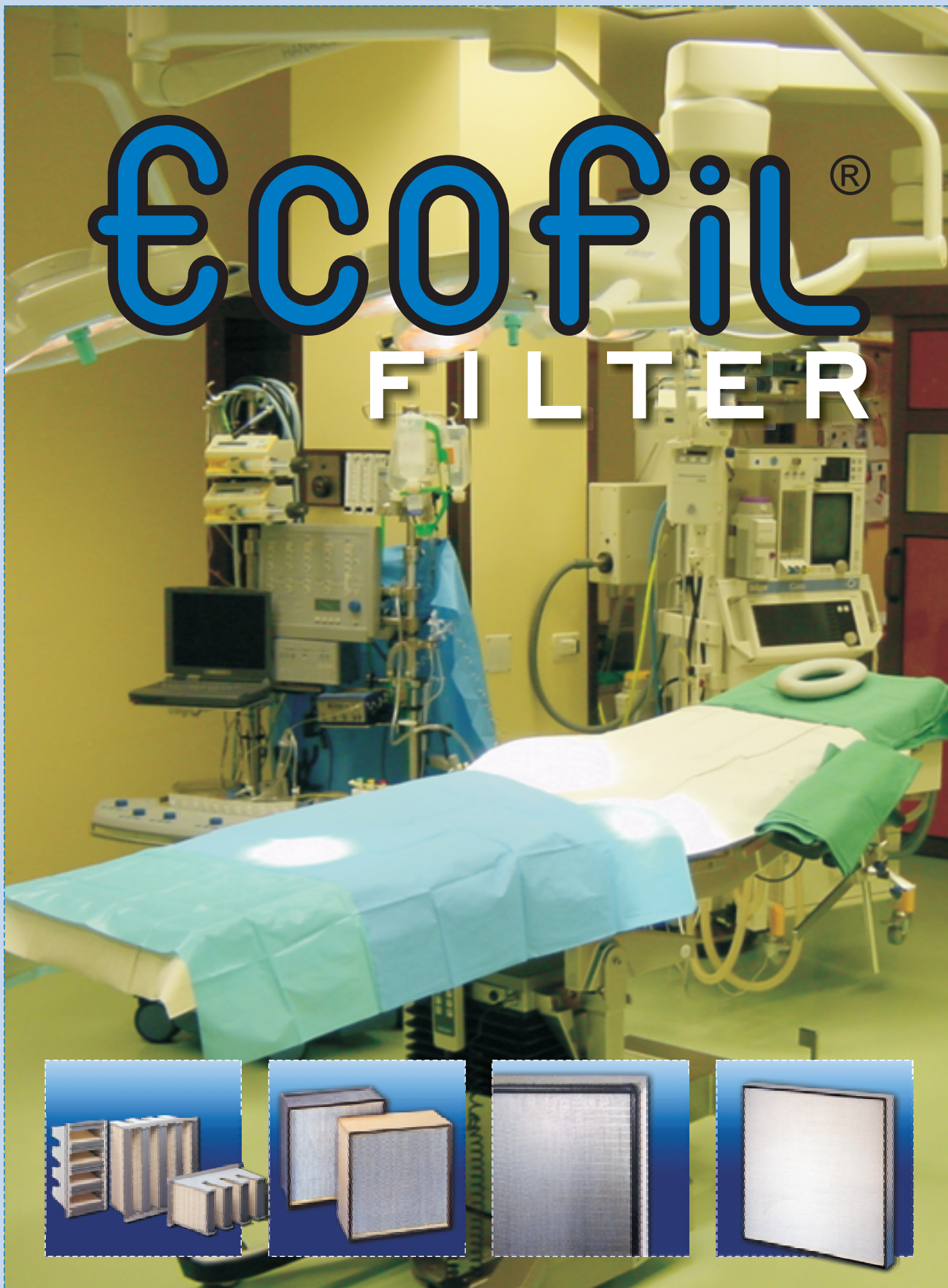

absolutni filtri absolute filters

ecofil®

FILTER

ultra filtracija ultra filtration

Kompaktni filtri

Compact filters

Filtrski razred **Filter class**
DIN 24 185/EN 779

Q, R, S

H 10 – H 14 & U 15 – U 17

Papirji iz mikro steklenih
vlakn

Micro glass-fibre paper

Pralno Washable.....Ne No



Element Element

Separatorski sistem

Separator system

Filtrski razred **Filter class**
DIN 24 185/EN 779

Q, R, S

H 10 – H 14 & U 15 – U 17

Papirji iz mikro steklenih
vlakn

Micro glass-fibre paper

Pralno Washable.....Ne No



Element Element

Mini plisirni sistem

Mini-pleat system

Filtrski razred **Filter class**
DIN 24 185/EN 779

Q, R, S

H 10 – H 14 & U 15 – U 17

Papirji iz mikro steklenih
vlakn

Micro glass-fibre paper

Pralno Washable.....Ne No



Element Element

Tehn. čistih sob

Clean Room Techn.

Filtrski razred **Filter class**
DIN 24 185/EN 779

Q, R, S

H 10 – H 14 & U 15 – U 17

Papirji iz mikro steklenih
vlakn

Micro glass-fibre paper

Pralno Washable.....Ne No



Element Element

HEPA filter

Absolutni filter **Absolute filter**

Preizkus po DIN 24184: razpršeno parafinsko olje

Test according to DIN 24184: sprayed paraffin oil

- Preizkus puščanja Leak rate test

Tip Type Star Old	Tip Type Nov New	Učinkovitost Efficiency Stara Old (%)	Učinkovitost Efficiency Nova New (%)
Q	H 10	≥ 85	≥ 85
R	H 11	≥ 98	≥ 95
S	H 12	≥ 99,97	≥ 99,5
S	H 13	≥ 99,997	≥ 99,95
S	H 14	≥ 99,999	≥ 99,995

ULPA filter

Visoko učinkovit absolutni filter

High efficient absolute filter

Preizkus po DIN DIN 24183/EN 1822: DEHS

Test according to 24183/EN 1822: DEHS

- Točkovni preizkus Scanning test

Tip Type Nov New	Učinkovitost Efficiency (%)
U 15	≥ 99,9995
U 16	≥ 99,99995
U 17	≥ 99,999995

ECOFIL® absolutni filtri so membranski filtri z zelo veliko sposobnostjo filtriranja 0,3 mikronskih delcev.

Uporaba: v klima napravah kot končna stopnja filtracije v farmaciji, operacijskih dvoranah, elektroniki, jedrskih centralah, mikrobiologiji ...

ECOFIL® absolute filters are membrane filters with a high filtration efficiency of 0.3 micron particles.

Application: in air handling units as the final stage of filtration in pharmacy, operating theatres, electronics, nuclear power plants, microbiology, etc.

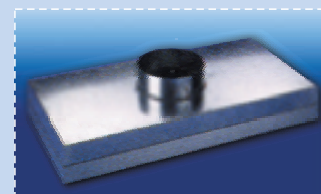

Filtrska oprema

Filter equipment

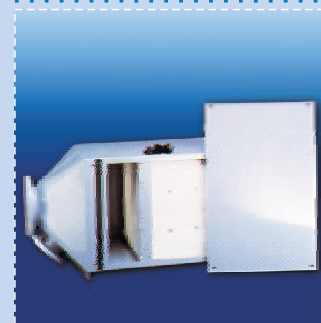

Ogljeni filtri

Carbon filters



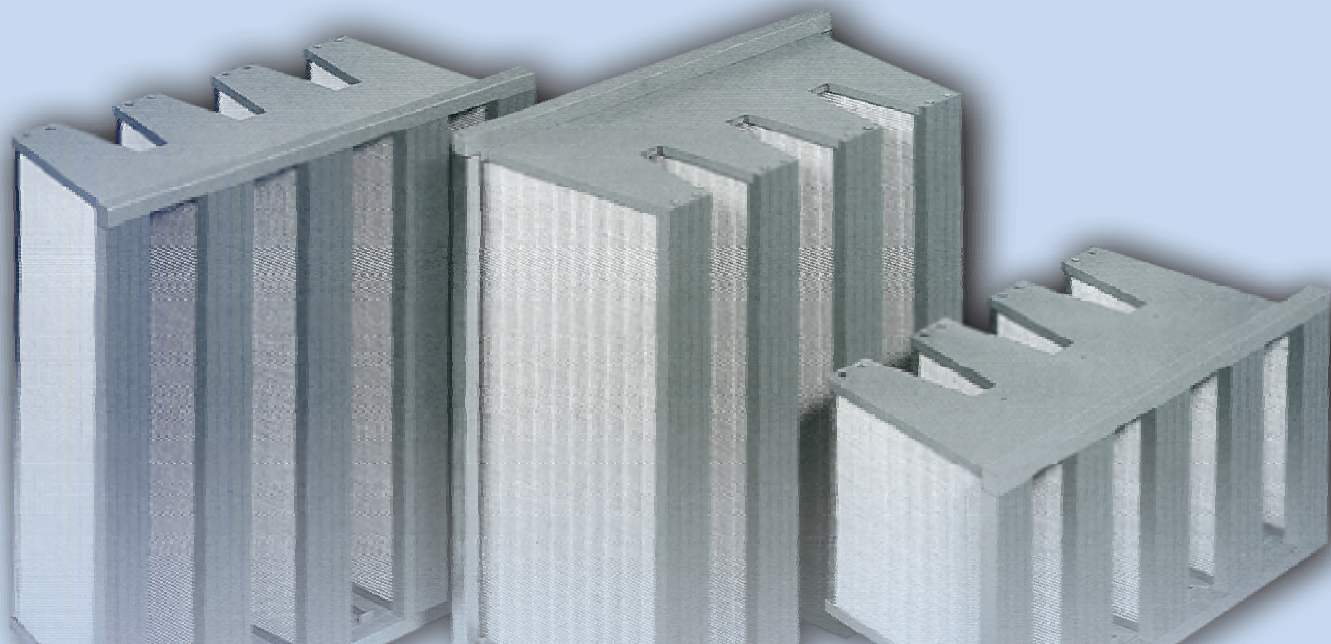

Ecofil® fino prašni filter FP

Ecofil® FP filtri za ločevanje finega prahu preprečujejo onesnaževanje zraka s prahom, dimom, paro, sajami, cvetnim prahom, bakterijami itd. Uporabljajo se kot predfiltri ali končni filtri, in sicer v napravah za prezračevanje in klimatizacijo prostorov.

Ecofil® FP filtri so vsestransko uporabni, še posebej v primerih, ko moramo zagotavljati **dolgo življenjsko dobo, varnost** in **prilagodljivost**. Filtri so na voljo v 8 različnih variantah glede na stopnjo zadržljivosti, v 4 glede na višino, v 2 glede na globino ter v 2 izvedbah (NT/HT).

Podatki

Obratovalna temperatura:

- Model «NT»: <75°C
 - Model «HT»: ≤120°C
- (ne velja za FP-65)

Tlačne razlike:

- priporočen končni padec tlaka: 450 Pa
- maksimalni končni padec tlaka: 800 Pa
- maksimalna vzdržljivost: >1500 Pa

Dopustna relativna vlažnost zraka:

- FP-65: <85 %
- FP-F6 do FP-F9 < 100 %

Materiali

Filtrski medij:

- FP-65: 18 m² celulozna vlakna
- FP-F6 do FP-F9: 18 m² plisirani papir iz steklenih vlaken

«NT» okvirji:

Odporni proti halogenom, recikliran polystyrol.

«HT» okvirji:

Umetni materiali in pocinkano jeklo.

Tesnilno sredstvo: polyurethan

Test sežigljivosti uporabljenih konstrukcijskih materialov:

- Model «NT»: K2/F2 po DIN 53438
- Model «HT»: K1/F1 po DIN 53438

Ecofil® Fine Dust Filter FP

Ecofil® FP Fine Dust Filters remove air contamination such as fine dust, smoke, vapor, soot, pollen, bacteria, etc. and are therefore ideally suitable as final filters or as prefilters for HERA- or ULPA-filters in air conditioning installations.

They are suitable for all standard filter applications, especially with those requiring increased **Service Life, Safety** and **Versatility**. **Ecofil®** FP Filters are available in 8 efficiencies, 4 nominal sizes, 2 depths and 2 models (NT/HT).

Application parameters

Continuous operating temperature:

- Model «NT»: <75°C
 - Model «HT»: ≤120°C
- (not valid for FP-65)

Pressure drop:

- recommended final pressure drop: 450 Pa
- max. final pressure drop (endurance strength): 800 Pa
- bursting pressure (new filter): >1500 Pa

Admissible relative humidity:

- FP-65: <85 %
- FP-F6 do FP-F9 < 100 %

Materials

Filter medium:

- FP-65: 18 m² cellulose fibre paper,
- FP-F6 do FP-F9: 18 m² glass fibre paper

Frame «NT»:

Incinerable halogenefree recycled Polystyrol

Frame «HT»:

Plastic and galvanized steel

Sealant: Polyurethane

Flammability class, of materials used:

- Model «NT»: K2/F2 according DIN 53438
- Model «HT»: K1/F1 according DIN 53438

TEHNIČNI PODATKI TECHNICAL DATA

Ecofil® fino prašni filter Ecofil® Fine Dust Filter	FP-	65-610	F6-610	F7-610	F8-610	F9-610
Pretok zraka Air flow	m ³ /h	5000	5000	5000	5000	4250
Začetni padec tlaka Initial pressure drop	Pa	140	135	140	150	140
Nominalni pretok zraka Rated air flow	m ³ /h	4250	4250	4250	4250	3400
Začetni padec tlaka Initial pressure drop	Pa	105	100	105	120	105
Filtrski razred po Filter class as per EN 779	-	F6	F6	F7	F8	F9
Povprečna učinkovitost Efficiency average EN 779	%	70	70	82	93	96
Povprečna zadržljivost Arrestance average EN 779	%	>95	>98	>99	>99	~100

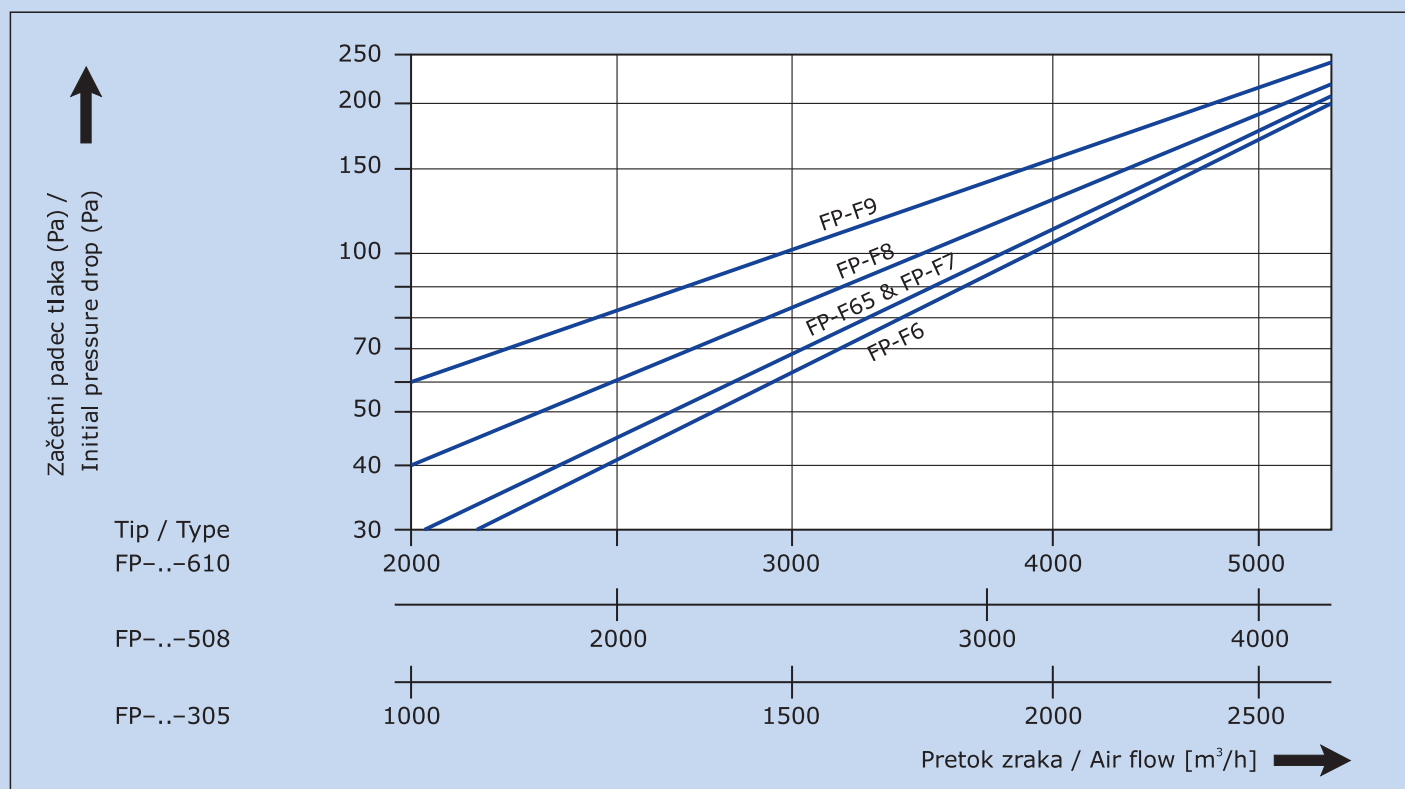

Ecofil® FP filtri za ločevanje finega prahu

- Bogata izbira uradno preizkušenih filtrov;
- Majhen padec pritiska - velik izkoristek
- Velika filtrirna površina, 18 m²;
- izredno dolga življenjska doba;
- pretok zraka do 5000 m³/h
- Papir iz mikro steklenih vlaken kot medij - minimalna obraba vlaken
- Samonosna, robustna celična zgradba - velika odpornost proti lomu, popolna zadržljivost prahu
- Možnost odločanja o smeri pretoka zraka in načinu vgradnje filtrov;
- Brez emisije škodljivih snovi - proizvodi so izdelani iz materialov, ki jih je moč reciklirati;
- Okvirji iz umetnih materialov.

Ecofil® Fine Dust Filter FP

- Comprehensive range - independently tested
- Low pressure drop - maximum economy
- Large filter surface of 18 m² - extremely long service life - nominal air flow up to 5000 m³/h
- Glass fibre paper - no fibre loss
- Self-supporting rigid structure - high bursting pressures, dust migration impossible
- Direction of air flow and installation can be chosen either way round
- Without pollutant emission fully incinerable - recyclable materials
- Frame manufactured from recycled plastic

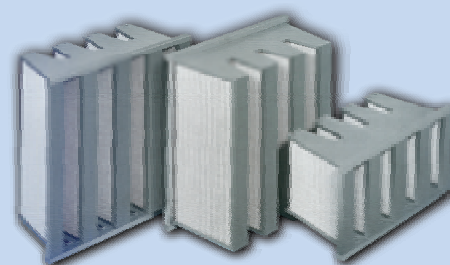
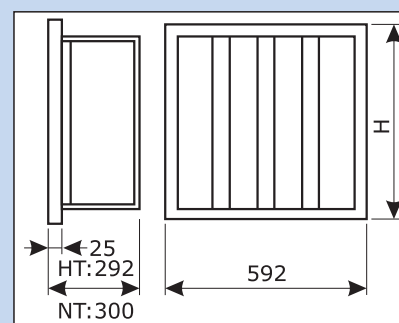

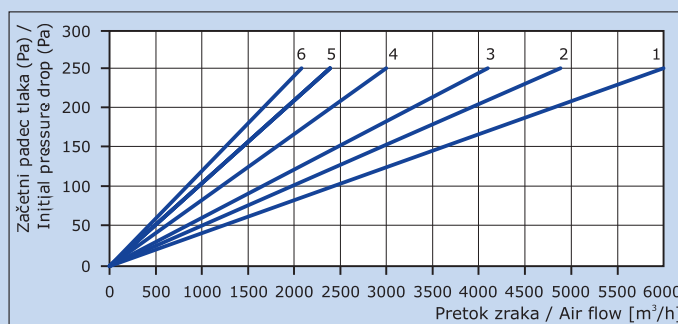
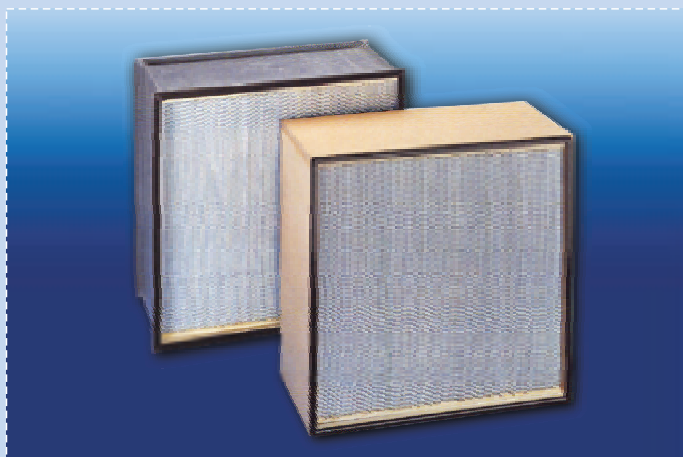

Filtrski razred (krivulja) Filter Class (Curve)		H11 (1)	H11 (2)	H11 (3)	H13 (4)	H13 (5)	H13 (6)
Dimenzije Dimensions	mm	610 x 610	610 x 610	610 x 610	610 x 610	610 x 610	610 x 610
Vgradna globina Depth	mm	292	292	292	292	292	292
Separator Separator	mm	2,9	3,9	4,9	2,9	3,9	4,9
Pretok zraka Air flow	m³/h	6000	4800	4200	3000	2400	2100
Padec tlaka Pressure drop	Pa	250	250	250	250	250	250

- Okvirji iz različnih materialov (MDF, legirano jeklo itd.)
- Robustna tehnika plisiranja filtrov
- Visoka temperaturna obstojnost (do 120 °C)
- Filtri z ali brez zaščitnih mrež
- Zagotovljena stoođstotna zatesnjenost filtrov
- Proizvodi izdelani po EN in DIN

- Wide range of frame materials (MDF, alloy steel etc.)
- Robust pleating technique
- Temperature resistance 120°C
- Filters with or without protecting nets
- 100 % sealing
- Products are tested according to DIN and EN

Ecofil® sedimentni filtri (H10 - H14)

Ecofil® Sediment Filters (H10 - H14)

Področje uporabe

Applications

Ecofil® filtre - filtrski razredi **H10-H14** - uporabljamo v primerih, ko moramo izpolnjevati najvišje zahteve po čistosti zraka:

Ecofil® Sediment Filters (Filter classes **H10-H14**) are used in air ventilation and air conditioning plants with extremely high requirements for air purity:

- v industrijskih procesih (mikroelektronika, farmacija, živilska industrija, medicina, optika, mikrobiologija itd.)
- v operacijskih dvoranh in v bolnišnicah
- pri filtraciji nevarnih snovi, kot so azbest, težke kovine ter kancerogeni prah
- na področju jedrske energije

- Industrial processes like microelectronics, pharmacy, food-processing industry, medicine, optics, microbiology etc.)
- Hospitals and hospital operating theatres
- Filtration of toxic and dangerous substances and materials like asbestos, heavy metals and carcinogenic dust
- Nuclear energy and nuclear research

Z uporab ultrafinih mikro steklenih vlaken in robustno tehniko plisiranja s pomočjo aluminijevih separatorjev dosegajo Ecofil® filtri izredno visoko kapaciteto zadrževanja submikronskih delcev, kar zagotavlja optimalne obratovalne pogoje.

Ecofil® filters are known for their special pleating technique and made of micro glass fibres, which guarantees an extremely high dust holding capacity and makes controlling of Laminar Flow possible.

Izvedbe

Okvirji: Večplasten les, MDF-plošče, pločevina iz legiranega jekla in pocinkana pločevina.

Models

Frame: Wood, MDF, alloy steel plate and galvanized sheet metal

Vgradne globine: 150, 292 mm

Depth: 150, 292 mm

Tesnjenje: PU-penasto tesnilo

Washers: PU - foam washers

Zaščita: Filtri z ali brez zaščitnih mrež.

Protection: Filters with or without protecting nets

Temperatura: do 120 °C
Relativna vlažnost zraka: do 100 %

Temperature: to 120 °C
Relative humidity: up to 100 %

Pri izdelavi Ecofil® filtrov se prilagajamo tudi zahtevam in željam strank; glede na zahteve nudimo možnost izdelave filtrov večjih zmogljivosti.

A comprehensive range of high quality filters; supply depending on demand of the customers.

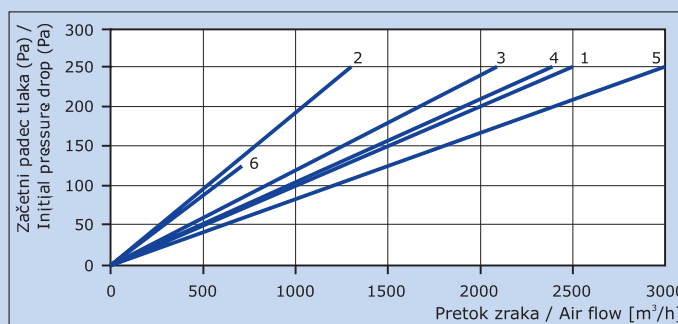
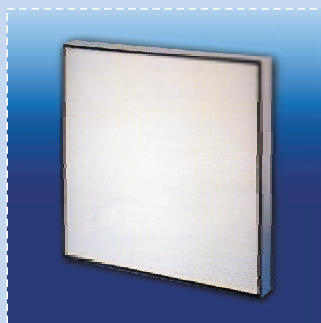
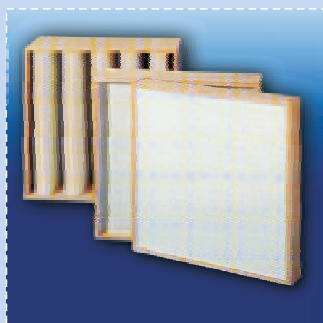

Filtrski razred (krivulja) Filter Class (Curve)

	H11 (1)	H13 (2)	H13 (3)	H13 (4)	H13 (5)	H14 (6)
Dimenzije Dimensions	mm 610 x 610	mm 610 x 610	mm 610 x 610	mm 610 x 610	mm 610 x 610	mm 610 x 610
Vgradna globina Depth	mm 78	mm 78	mm 150	mm 292	mm 292	mm 78
Delovna globina Working depth	mm 65	mm 65	mm 100	mm 150	mm 230	mm 65
Pretok zraka Air flow	m³/h 2500	m³/h 1260	m³/h 2100	m³/h 2400	m³/h 3000	m³/h 600
Padeč tlaka Pressure drop	Pa 250	Pa 250	Pa 250	Pa 250	Pa 250	Pa 125

- Zadržljivost od 85 %-99,999995 %
- Okvirji iz različnih materialov (aluminij, MDF itd.)
- Različne vrste tesnil (penasta ravna in gel tesnila ter tesnilni žeblički)
- Filtri z ali brez zaščitnih rešetk
- Zagotovljena stoođstotna zatesnjenost filtrov
- Proizvodi izdelani po EN in DIN

- Efficiency from 85 % up to 99,999995%
- Extensive range of frames and materials (aluminium, MDF, etc.)
- Wide range of washers
- Filters with or without protecting nets
- 100 % sealing
- Products are tested according to DIN and EN

Ecofil® sedimentni filtri (H10-14 & U15-17)

Ecofil® Sediment Filters (H10-14 & U15-17)

Področje uporabe

Ecofil® filtre - filtrski razredi **H10-H14 in U15-U17** - uporabljamo v primerih, ko moramo izpolnjevati najvišje zahteve po čistosti zraka:

- v industrijskih procesih (mikroelektronika, farmacija, živilska industrija, medicina, optika, mikrobiologija itd.)
- v operacijskih dvoranah in v bolnišnicah
- v čistih sobah
- v ventilacijskih enotah
- pri filtraciji nevarnih snovi, kot so azbest, težke kovine ter kancerogeni prah
- na področju jedrske energije

Spričo uporabe ultrafinih mikro steklenih vlaken in tehnike plisiranja imajo **Ecofil®** filtri izredno visoko kapaciteto zadrževanja submikronskih delcev, kar zagotavlja nadzorovan pretok zraka.

Prednosti za uporabnika:

Ecofil® filtri zagotavljajo maksimalne učinke ob minimalni porabi energije.

Izvedbe

Okvirji: Aluminij, les, MDF-plošče, pločevina iz legiranega jekla in pocinkana pločevina.

Vgradne globine: 46, 54, 69, 75, 78, 150, 292 mm

Tesnjenje: Penasta ravna in gel tesnila, U-profil tesnila ter visokotemperaturna tesnila.

Zaščita: Filtri z ali brez zaščitnih rešetk.

Temperatura: do 80 °C

Relativna vlažnost zraka: do 100 %

Pri izdelavi **Ecofil®** filtrov se prilagajamo tudi zahtevam in željam strank; glede na zahteve nudimo možnost izdelave filtrov večjih zmogljivosti.

Applications

Ecofil® Sediment Filters (Filter classes **H10-H14 and U15-U17**) are used in air ventilation and air conditioning plants with extremely high requirements for air purity:

- Industrial processes like microelectronics, pharmacy, food-processing industry, medicine, optics, microbiology etc.)
- Hospitals and hospital operating theatres
- Laminar Flow Boxes
- Filter-Fan-Units
- Filtration of toxic and dangerous substances and materials like asbestos, heavy metals and carcinogenic dust
- Nuclear energy and nuclear research

Ecofil® filters are known for their special pleating technique and made of micro glass fibres, which guarantees an extremely high dust holding capacity and makes controlling of Laminar Flow possible.

Advantages for the users:

Maximal efficiency with minimal energy costs.

Models

Frame: Aluminium, wood, MDF, alloy steel plate and galvanized sheet metal

Depth: 46, 54, 69, 75, 78, 150, 292 mm

Washers: Wide range of washers, which make sealing possible

Protection: Filters with or without protecting nets

Temperature: to 80°C

Relative humidity: up to 100 %

A comprehensive range of high quality filters; supply depending on demand of the customers.

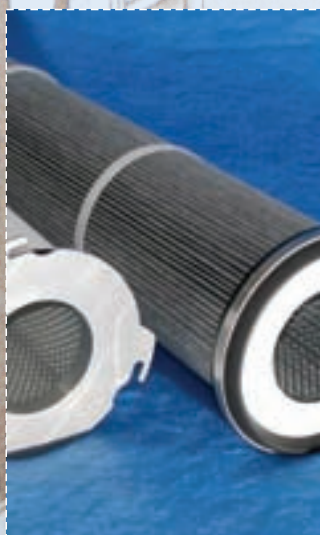

Krožni zračni filtri - patrone



Radial air filter cartridges

ECOFIL® filter patrone so namenjene široki uporabi v motorjih tovornjakov, avtobusov, kmetijski in gradbeni mehanizaciji ter pri vsej drugi težki mehanizaciji in strojih. Visoko kakovostne ECOFIL® filter patrone so proizvedene v skladu z visokimi standardi kvalitete po DPS in 2DPS.

ECOFIL® filter cartridges are used in bus and truck engines, agricultural machinery, construction equipment and machinery, as well as in heavy-duty engines.

ECOFIL® filter cartridges are produced to a very high standard of quality according to DPS and 2DPS systems.

Krožni tesnilni zračni filtri

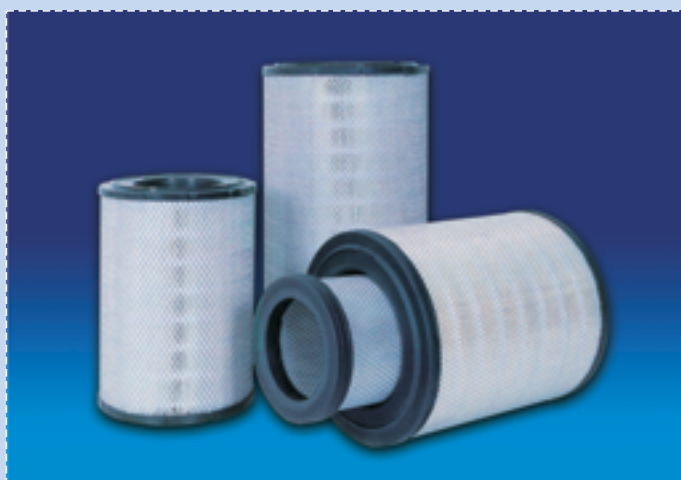

Radial seal air filters

ECOFIL® zračni filtri s poliuretanskim tesnilnim obročem so narejeni v skladu s plisirnimi sistemi DPS in 2DPS. Primerni so za uporabo v skrajnih pogojih filtracije.

ECOFIL® air filters with special micro cell polyurethane sealing rings are produced in compliance with DPS and 2DPS pleating systems. They are suitable for the application of filtration under extreme conditions.

Ecofil® filter adapter

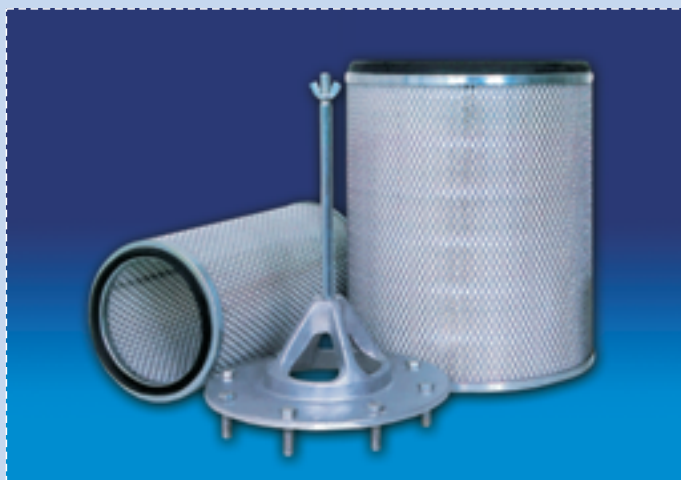

Ecofil® filter adaptor

DPS je plisirni sistem filtrov z največjo možno učinkovitostjo pri filtraciji. Z uporabo tega sistema zagotovimo enakomeren medprostor med gubami in temu ustrezen pretok zraka skozi filter. Reže med gubami se ne spremenijo niti v ekstremnih pogojih filtracije, emisijska površina pa se ne spremeni oz. ne zmanjša. Tako sta omogočena normalen pretok zraka in dolgotrajna učinkovitost filtra.

DPS is a pleating filter system with the highest possible filtration efficiency. When using this system, equal space between the pleats and the corresponding air flow through the filter are ensured. Even under extreme conditions of filtration the gaps between the pleats never change, and the emission surface does not change or decrease either. Thus, a regular air flow and long lasting efficiency of the filter are provided.

	Ecofil® PE/PE 351	Ecofil® PE/PE 401	Ecofil® PE/PE 451	Ecofil® PE/PE 501	Ecofil® PE/PE 501 Si	Ecofil® PE/PE 504 glaze CS17	Ecofil® PE/PE 551 glaze	Ecofil® PE/PE 551 Si	Ecofil® PE/PE 551 CS17	Ecofil® PE/PE 354 Epi glaze (ACU)	Ecofil® PE/PE 401 Epi (ACU)	Ecofil® PE/PE 451 Epi (ACU)	Ecofil® PE/PE 501 Epi (ACU)	Ecofil® PE/PE 551 Epi (ACU)	Ecofil® PE/PE 554 glaze ExCharge	Ecofil® PE/PE 551 ExCharge CS17	Ecofil® PP/PP 504	Ecofil® PP/PP 554	Ecofil® AC/AC 551
1 Artikel Article																			
2 Koda TAN	3440	2732	1012	2733	3031	4951	5495	3342	3753	5540	1119	5105	1120	4046	4993	5058	3784	2113	3014
3 Sestava Composition vlaknasti sloj <i>web</i> tkanina <i>scrim</i>	(a) (a)	(a) (a)	(a) (a)	(a) (a)	(a) (a)	(a) (a)	(a) (a)	(a) (a)	(a) (a)	(a) (a)	(a) (a)	(a) (a)	(a) (a)	(a) (a)	(a) (a)	(a) (a)	(i) (i)	(i) (i)	(g) (g)
4 Teža Area Weight [g/m²] ISO 9073-1	350	400	450	500	500	500	550	550	550	350	400	450	500	550	550	550	500	550	550
5 Debelina Thickness [mm]	1.5	1.6	1.7	2	2.1	1.7	2	1.9	1.9	1.1	1.6	1.9	1.9	1.9	1.8	1.9	2.1	2.2	2.4
6 Gostota Density [g/cm³]	0.23	0.25	0.26	0.25	0.24	0.29	0.28	0.29	0.29	0.32	0.25	0.24	0.26	0.29	0.31	0.29	0.24	0.25	0.23
7 Propustnost Air Permeability EN ISO 9237 [mm/s @ 200 Pa]	583 (J)	417 (A)	417 (A)	333 (E)	333 (E)	267 (K)	250 (F)	250 (F)	250 (F)	417 (A)	417 (A)	458 (M)	333 (E)	250 (F)	217 (L)	250 (F)	333 (E)	200 (C)	250 (F)
8 Volumen por Pore Volume [%]	83	82	81	82	83	79	80	79	79	77	82	83	81	79	78	79	74	73	80
9 Raztržnost Tensile Strength [daN] ISO 9073-3 velikost vzorca <i>Sample size</i> 200/50 mm vzdolžno <i>length</i> prečno <i>cross</i>	155 130	150 150	150 145	165 160	115 130	175 175	185 160	155 165	165 170	185 130	150 145	185 130	155 145	155 165	155 175	145 170	185 165	180 190	60 95
10 Razteznost Elongation at Break [%] ISO 9073-3 vzdolžno <i>length</i> prečno <i>cross</i>	21 22	21 23	20 26	21 24	18 23	21 23	20 28	20 25	21 28	21 24	21 22	22 23	21 23	20 27	21 28	20 27	23 24	22 28	15 30
11 Temperaturna obstojnost* [°C] Temperature Resistance* [°C] trajna <i>cont.</i> kratkotrajna <i>peaks.</i>	150 150	150 150	150 150	150 150	150 150	150 150	150 150	150 150	150 150	150 150	150 150	150 150	150 150	150 150	150 150	150 150	90 95	90 95	115 120
12 Največja sprememba dimenzij [°C] max. Change of Dimensions [°C] pri 150°C at 150°C	<1	<1	<1	<1	<1	<1	<1	<1	<1	<1	<1	<1	<1	<1	<1	<1	<1	<1	<1
13 Dodatna obdelava površine Surface Design/Treatment	(1) (2)	(1) (2)	(1) (2)	(1) (2)	(1) (2)	(1) (6)	(1) (6)	(1) (2)	(1) (2)	(1) (6)	(1) (2)	(1) (2)	(1) (2)	(1) (2)	(1) (6)	(1) (2)	(1) (2)	(1) (2)	(1) (2)

DODATNA OBDELAVA ADDITIONAL TREATMENTS

- (1) » Toplotno stabiliziran / Termo fiksiran » Heat set
- (2) » Smojena površina » Singed face side
- (3) » Antistatična mešanica vlaken » Epitropic fibre admixture
- (4) » Mikro pore iz mikro vlaken » Micro pores by fine fibres
- (5) » Olje in vodoodbojna impregnacija za boljše čiščenje prašnih delcev
» Full bath oil and water repellent finish for optimal cake release
- (6) » Zaglajen / kalandriran » Glazed face side
- (7) » Na voljo v širinah 200 cm, 210 cm in 220 cm » Available 200 cm, 210 cm and 220 cm width
- (8) » Teflonska površinska impregnacija » PTFE surface coating
- (9) » Obdelava za boljše odpadanje prahu (izločanje) » Full bath antiadhesive finish
- (10) » Konstantna prevodna matrika iz kovinskih niti; upornost <10⁶ Ohm (DIN 54345 del 1 in del 5)
» Permanent conductive matrix, resistance <10⁶ Ohm (DIN 54345 part 1 and part 5)
- (11) » Polna teflonska impregnacija » Full bath PTFE treatment
- (12) » ACU-antistatik z bakrenimi vlakni-upornost <10³ Ohm (DIN 54345 del 1 in del 5)
» ACU-antistatic with coppers fibers composition-resistivity <10³ Ohm (DIN 54345 part 1 and part 5)

SESTAVNI MATERIALI

- (a) Poliester
- (b) Poliakril homopolimer
- (c) Polifenil sulfid
- (d) Meta aramid
- (e) Polimid
- (f) Teflon
- (g) Poliakril - kopolimer
- (h) Poliamid-imid
- (i) Polipropilen

OPOMBE
* Kemijski sestav dimnih plinov lahko zahteva nižje obratovalne temperature

tabela filtrov filter table

Ecofil® DT/DT 501	Ecofil® DT/DT 554 glaze	Ecofil® DT/DT 551 MPS	Ecofil® DT-PE/DT-PE 551 MPS	Ecofil® DT-PE/DT-PE 601	Ecofil® PPS/PPS 551	Ecofil® PPS/PPS 551 MPS	Ecofil® PPS/PPS 554 CS17	Ecofil® PPS/PPS 554 CS30	Ecofil® PPS/PPS 601	Ecofil® NO/NO 401	Ecofil® NO/NO 501	Ecofil® NO/NO 501 CS17	Ecofil® NO/NO 551	Ecofil® NO/NO 554 CS17	Ecofil® AsphaltTec LPC	Ecofil® AsphaltTec HPC	Ecofil® PI/PI 501	Ecofil® PI/PI 501 CS30	Ecofil® PI/PI 551	Ecofil® PI/PI 551 MPS	Ecofil® PI/PI 554 CS17	Ecofil® PTFE/PTFE 752 MPS	Ecofil® PTFE/PTFE 754 MPS CS18	Ecofil® PTFE/PTFE 754 MPS CS30	Ecofil® TFL/PTFE 752 MPS	Ecofil® TFL/PTFE 754 MPS CS18
4863	4474	1181	5899	1661	4571	4429	4340	5422	1473	1665	1792	1682	2235	2087	6097	6098	2521	6078	1939	2684	2774	4375	3951	5716	6066	2930
(b)	(b)	(b)	(b) + (a)	(b) + (a)	(c)	(c)	(c)	(c)	(c)	(d)	(d)	(d)	(d)	(d)	(h)	(h)	(e)	(e)	(e)	(e)	(e)	(f)	(f)	(f)	(f)	(f)
(b)	(b)	(b)	(b) + (a)	(b) + (a)	(c)	(c)	(c)	(c)	(c)	(d)	(d)	(d)	(d)	(d)	(d)	(d)	(e)	(e)	(e)	(e)	(e)	(f)	(f)	(f)	(f)	(f)
500	550	550	550	600	550	550	550	550	600	400	500	500	550	550	400	500	500	500	550	550	550	750	750	750	750	750
2.5	2.4	2.1	2	2.1	1.8	1.8	1.6	1.7	1.8	2.1	2.5	2.3	2.5	2.3	2.1	2.4	2.7	2.6	2.7	2.4	2.4	1.5	1.5	1.2	1.5	1.2
0.2	0.23	0.26	0.28	0.29	0.31	0.31	0.34	0.32	0.33	0.19	0.2	0.22	0.22	0.24	0.19	0.21	0.19	0.19	0.2	0.23	0.23	0.5	0.5	0.63	0.5	0.63
333 (E)	167 (H)	125 (B)	167 (H)	150 (D)	250 (F)	167 (H)	200 (C)	200 (C)	200 (C)	417 (A)	333 (E)	333 (E)	250 (F)	225 (G)	417 (A)	333 (E)	333 (E)	250 (F)	250 (F)	167 (H)	200 (C)	183 (I)	167 (H)	167 (H)	250 (F)	183 (I)
83	81	78	78	77	77	77	75	77	76	86	86	84	84	88	86	84	87	87	86	84	84	76	76	70	76	70
35	100	105	115	105	85	90	85	65	85	40	45	45	40	65	50	50	75	60	80	80	80	90	90	90	80	75
115	130	80	155	180	155	140	135	105	165	110	150	150	165	165	85	145	130	135	130	180	130	95	95	90	95	95
10	12	14	18	19	23	22	23	23	22	20	23	22	21	24	14	20	20	16	20	20	20	7	8	7	8	9
26	26	14	22	23	37	28	39	49	40	42	40	41	42	42	25	30	30	30	30	30	30	19	12	43	48	47
125	125	125	125	125	190	190	190	190	190	200	200	200	200	200	170	170	240	240	240	240	240	250	250	250	250	250
140	140	140	140	140	200	200	200	200	200	220	220	220	220	220	190	190	260	260	260	260	260	280	280	280	280	280
<1	<1	<1	<1	<1	<1	<1	<1	<1	<1	<1	<1	<1	<1	<1	<1	<1	<1	<1	<1	<1	<1	<2	<2	<2	<2	<2
(1)	(1)	(1)	(1)	(1)	(1)	(1)	(1)	(1)	(1)	(1)	(1)	(1)	(1)	(1)	(1)	(1)	(1)	(1)	(1)	(1)	(1)	(1)	(1)	(1)	(1)	(1)
(2)	(6)	(2)	(2)	(2)	(2)	(2)	(6)	(6)	(2)	(2)	(2)	(2)	(6)	(2)	(2)	(2)	(2)	(2)	(2)	(2)	(6)	(4)	(6)	(6)	(4)	(6)
		(4)	(4)			(4)	(5)	(11)				(5)	(5)				(11)		(4)	(5)		(4)	(4)	(11)	(8)	

COMPOSITION MATERIALS

- Polyester
- Polyacrylonitrile Homopolymer
- Polyphenylene Sulphide
- m-Aramide
- Polyimide
- PTFE
- Polyacrylonitrile Copolymer
- Polyamide-imide
- Polypropylene

REMARKS
* Chemical gas stream conditions may require a lower continuous operating temperature to be maintained

(A)	odg.	250 l/(dm ² min)	pri 200 Pa	resp.	250 l/(dm ² min)	@ 200 Pa
(B)	odg.	75 l/(dm ² min)	pri 200 Pa	resp.	75 l/(dm ² min)	@ 200 Pa
(C)	odg.	120 l/(dm ² min)	pri 200 Pa	resp.	120 l/(dm ² min)	@ 200 Pa
(D)	odg.	90 l/(dm ² min)	pri 200 Pa	resp.	90 l/(dm ² min)	@ 200 Pa
(E)	odg.	200 l/(dm ² min)	pri 200 Pa	resp.	200 l/(dm ² min)	@ 200 Pa
(F)	odg.	150 l/(dm ² min)	pri 200 Pa	resp.	150 l/(dm ² min)	@ 200 Pa
(G)	odg.	135 l/(dm ² min)	pri 200 Pa	resp.	135 l/(dm ² min)	@ 200 Pa
(H)	odg.	100 l/(dm ² min)	pri 200 Pa	resp.	100 l/(dm ² min)	@ 200 Pa
(I)	odg.	110 l/(dm ² min)	pri 200 Pa	resp.	110 l/(dm ² min)	@ 200 Pa
(J)	odg.	350 l/(dm ² min)	pri 200 Pa	resp.	350 l/(dm ² min)	@ 200 Pa
(K)	odg.	160 l/(dm ² min)	pri 200 Pa	resp.	160 l/(dm ² min)	@ 200 Pa
(L)	odg.	130 l/(dm ² min)	pri 200 Pa	resp.	130 l/(dm ² min)	@ 200 Pa
(M)	odg.	275 l/(dm ² min)	pri 200 Pa	resp.	275 l/(dm ² min)	@ 200 Pa



ecofil[®]
FILTER

Filtrske patrone

Tehnološko izpopolnjena patrona z dvakratno življenjsko dobo in izboljšano učinkovitostjo.

Posebna konstrukcija teh patron omogoča dvakrat daljšo življenjsko dobo, kot jo imajo navadni filtri za filtriranje tekočin. Računalniška obdelava je optimizirala patrono, tako da je izkoriščena maksimalna površina. Izboljšana konstrukcija v primerjavi s tovrstnimi standardnimi filtri omogoča večje zadrževanje umazanije (povprečno dvakrat večje) in zagotavlja globinsko filtracijo.

Patrone so na razpolago v naslednjih kakovostnih razredih: 1 µm, 3 µm, 5 µm, 10 µm, 20 µm, 30 µm, 50 µm in 100 µm.

Uporabljajo se pri raznih vodnih procesih, kemičnih in foto procesih, pri obdelavi derivatov, pri uporabi pitnih tekočin ...



Filter cartridges

Technologically advanced cartridge with a doubled cartridge life, and improved performance.

The unique construction of cartridges provides twice the average life of conventional cartridges for fluid filtration. Computer modelling has optimized the cartridge's geometry, thus enabling full use of the cartridge's surface. The enhanced design provides improved dirt-holding capacity (twice the average) over standard cartridges, whilst providing secure deep bed filtration.

They are available in the qualities of 1 µm, 3 µm, 5 µm, 10 µm, 20 µm, 30 µm, 50 µm and 100 µm.

Applications: water treatment processing, chemical and photographic processing, treatment of derivatives, beverages etc.

Filtrske vreče

ECOFIL® filter vreče omogočajo visoko kvaliteto in zelo učinkovito filtracijo.

ECOFIL® vreče so idealne za odstranjevanje trdnih delcev v kakršnemkoli procesu. Ti filtri se proizvajajo in testirajo v zelo strogih pogojih za zagotavljanje učinkovite filtracije. Te filter vreče se uporabljajo pri visoki stopnji pretoka, kjer gostota tekočine (nad 10.000 cps) zahteva filtracijo.

ECOFIL® vreče so na razpolago v naslednjih kakovostnih razredih: 1 µm, 2,5 µm, 5 µm, 10 µm in 25 µm (zadrževanje delcev).

Uporaba: lepila, pijače, premazi, hladila, črnila, detergenti, barve, pralni sistemi, v rafineriji, razkrojila, umetna smola ...



Filtering bags

ECOFIL® filtering bags provide high quality, efficient and consistent filtration.

ECOFIL® filtering bags are ideal for removing solid particles in virtually any processing. They are manufactured and tested under the strictest quality control standards to assure efficient performance. These filtering bags are used at a high flow rate, where a liquid density above 10.000 cps requires filtration.

ECOFIL® filtering bags are available in categories of 1 µm, 2,5 µm, 5 µm, 10 µm and 25 µm (particle retention ratings).

Applications: adhesives, beverages, coatings, coolants, inks, detergents, paints, washing systems, oil refineries, dissolutions, synthetic resins etc.

Vpojna patrona

Učinkovito in ekonomično odstranjevanje ogljikovodikov z vpojno patrono.

Vpojna patrona uporablja modificiran polimer, ki ekonomično in učinkovito zmanjša prisotnost ogljikovodikov v tekočinah.

Radialna zgradba filtra omogoča maksimalno uporabo površine. Uporabljamo ga lahko samostojno ali v kombinaciji z drugimi filtri. Vpojne patrone rešijo mnogo problemov, ki se pojavijo z onesnaženostjo vode in drugih tekočin z ogljikovodiki.

Uporaba: industrijsko čiščenje odpadne vode, čistilne naprave v rafinerijah, v avtopralnicah in v pralnicah.



Absorbent cartridge

Effective and economic removal of hydrocarbons with the aid of absorbent cartridge.

An absorbent cartridge utilizes a modified polymer for economic and effective reduction of any hydrocarbon present in fluids.

The radial filter structure provides maximum utilization of available surface area. This product can be used independently or in combination with other filters. It solves many problems concerning the contamination of water and other fluids containing hydrocarbons.

Applications: industrial waste-water treatment, cleaning plants in oil refineries, car washes and other similar places.

Ultra filtracija

Kvalitetna rešitev filtracije z najlon membransko filtrno patrono.

Najlon membranska filtrska patrona omogoča široko kemično kompatibilnost in visoko učinkovitost na nivojih nizkega izločanja pri kritičnih tokovih procesnih tekočin. Idealni so pri bioloških filtracijah.

Proizvajajo se v naslednjih kakovostnih razredih (velikost pore): 0,1 µm, 0,2 µm, 0,45 µm in 0,65 µm.

Uporaba: v prehrabeni industriji, kemični in medicinski industriji, informacijski industriji (optika, računalništvo, fotografija) ...



Ultra filtration

Quality filtration solution with the aid of a nylon-membrane filter cartridge.

Nylon membrane filter cartridges provide a wide range of chemical compatibility and highly-rated efficiency at low extractable levels in critical process fluid streams. They are ideal for biological filtration applications and are available in pore sizes of 0.1 µm, 0.2 µm, 0.45 µm and 0.65 µm.

Applications: in food processing, chemical and medical industries, informatic industries (optics, computer technology, photographic), etc.

Tlačni lamelni filter

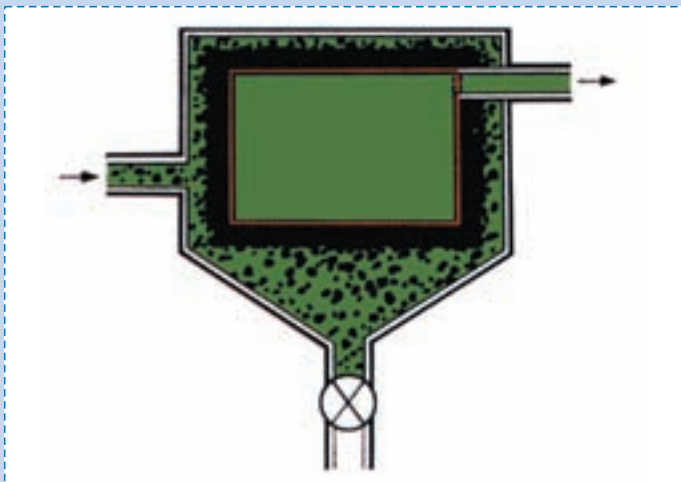

Pressure leaf filter

Odstopna ploščna filtrska stiskalnica

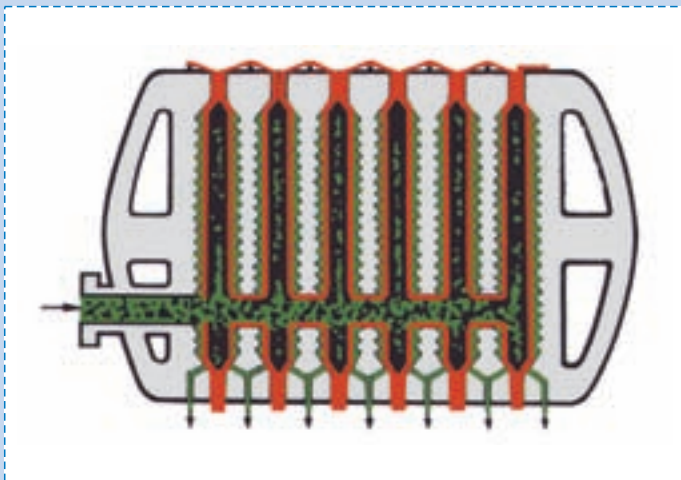

Recessed plate filter press

Večvaljčna tračna stiskalnica

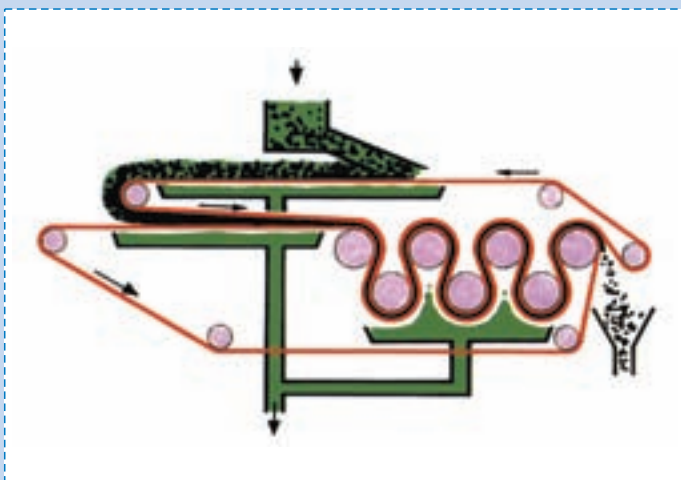

Multi roll-belt press

Material za filter stiskalnice za izločevanje trdnih delcev iz tekočin

Material used in filter presses for liquid/solid separation

 Blato
Slurry

 Filtrski medij
Filter media

 Čisti filtrat
Clear filtrate



Ploščna in okvirna filtrska stiskalnica

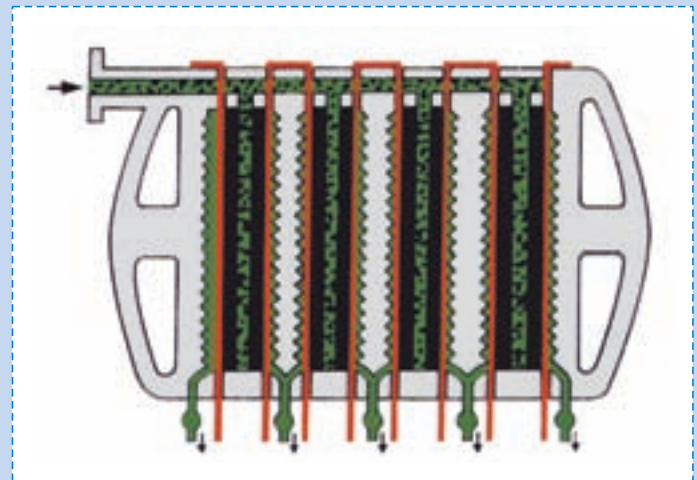
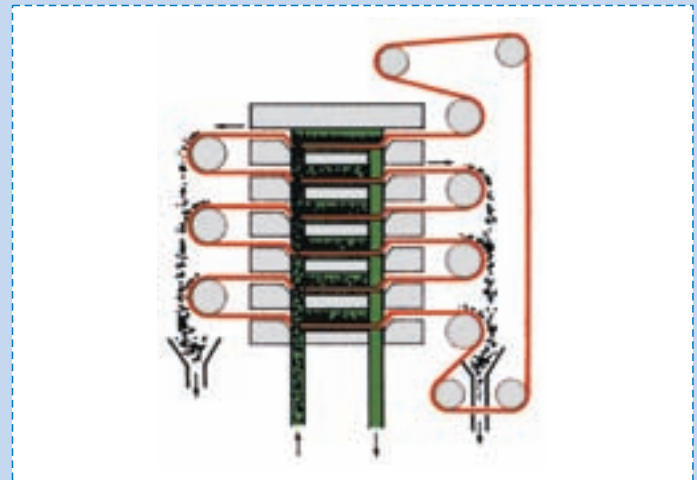

Plate and frame filter Press

Vertikalna avtomatska filtrska stiskalnica



Vertical fully-automatic filter press

Rotacijski vakuum-disk filter



Rotary Vacuum disc filter

Vakuumi filtrski trak

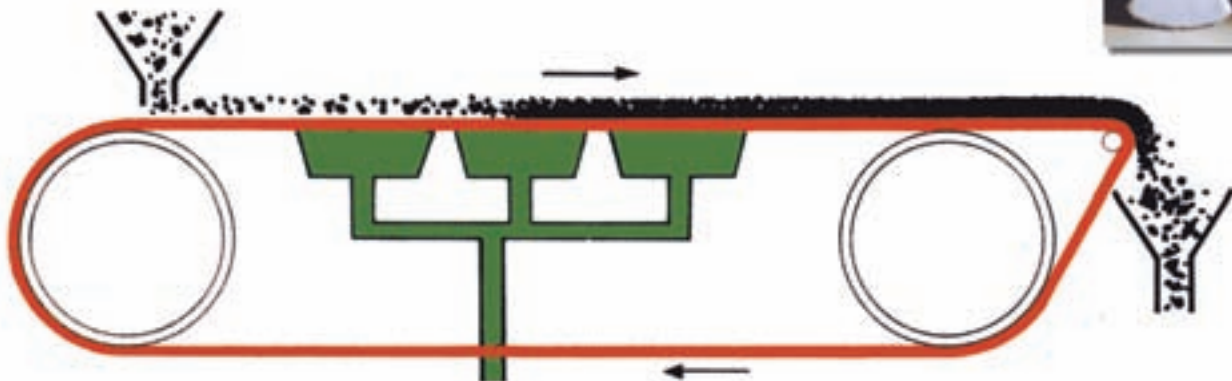

Vacuum filter belt

Rotacijski vakuumski bobnasti filter



Rotary Vacuum drum filter

Vakuumski filtri za izločevanje trdnih delcev iz tekočin

Vacuum filters for liquid/solid separation

 Blato
Slurry

 Filtrski medij
Filter media

 Čisti filtrat
Clear filtrate



