

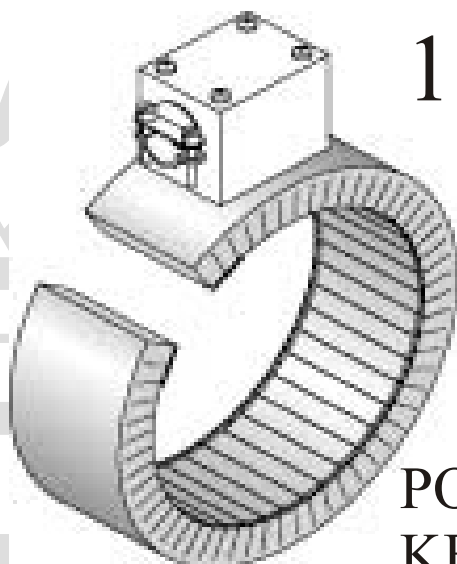

Electrolux

INDUSTRIJA ZA EL. GREACI
I GUMENI PROIZVODI



1

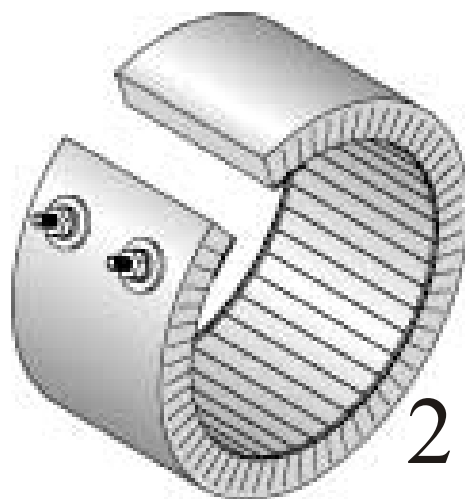

2

PORACKA
KERAMICKI
POJASNI GREACI



3

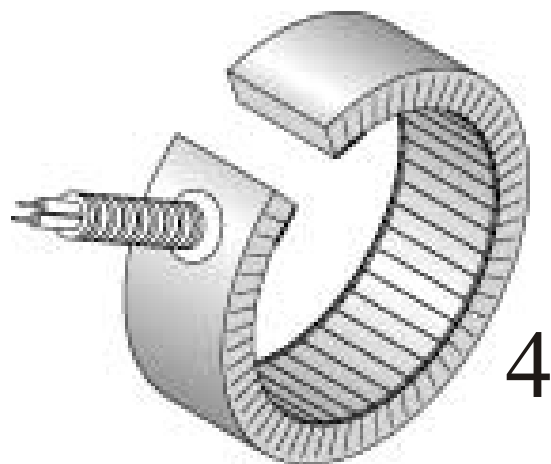

4

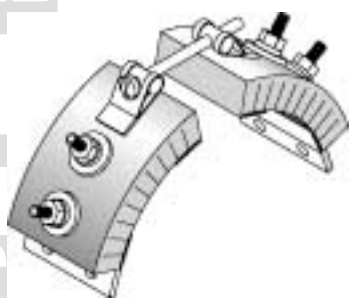

5

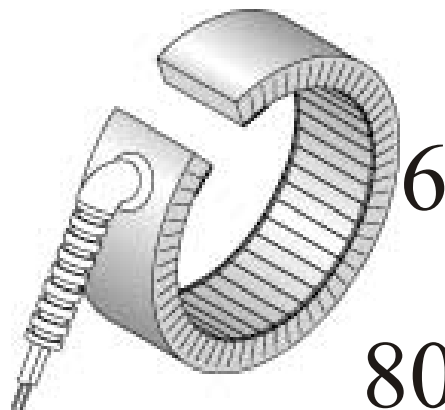

6

801

Adresa: ul.Braka Mingovi 18, 7000 Bitola; tel: 047/203-330 ,203 900ul.A.Guslarot.1a 02/329 8 130 Skopje

www.elektroluks.com.mk.mk e-mail: elek-palenzo@mt.net.mk



Electrolux

INDUSTRIJA ZA EL. GREACI
GUMENI PROIZVODI



1



2



3

PORACKA POJASNI GREACI



4



5



6



7



8



9



10



11



13

802

Adresa: ul.Braka Mingovi 18, 7000 Bitola; tel: 047/203-330 ,203 900ul.A.Guslarot.1a 02/329 8 130 Skopje

www.elektroluks.com.mk. e-mail: elek-palenzo@mt.net.mk



Electrolux

INDUSTRIJA ZA EL. GREACI
GUMENI PROIZVODI

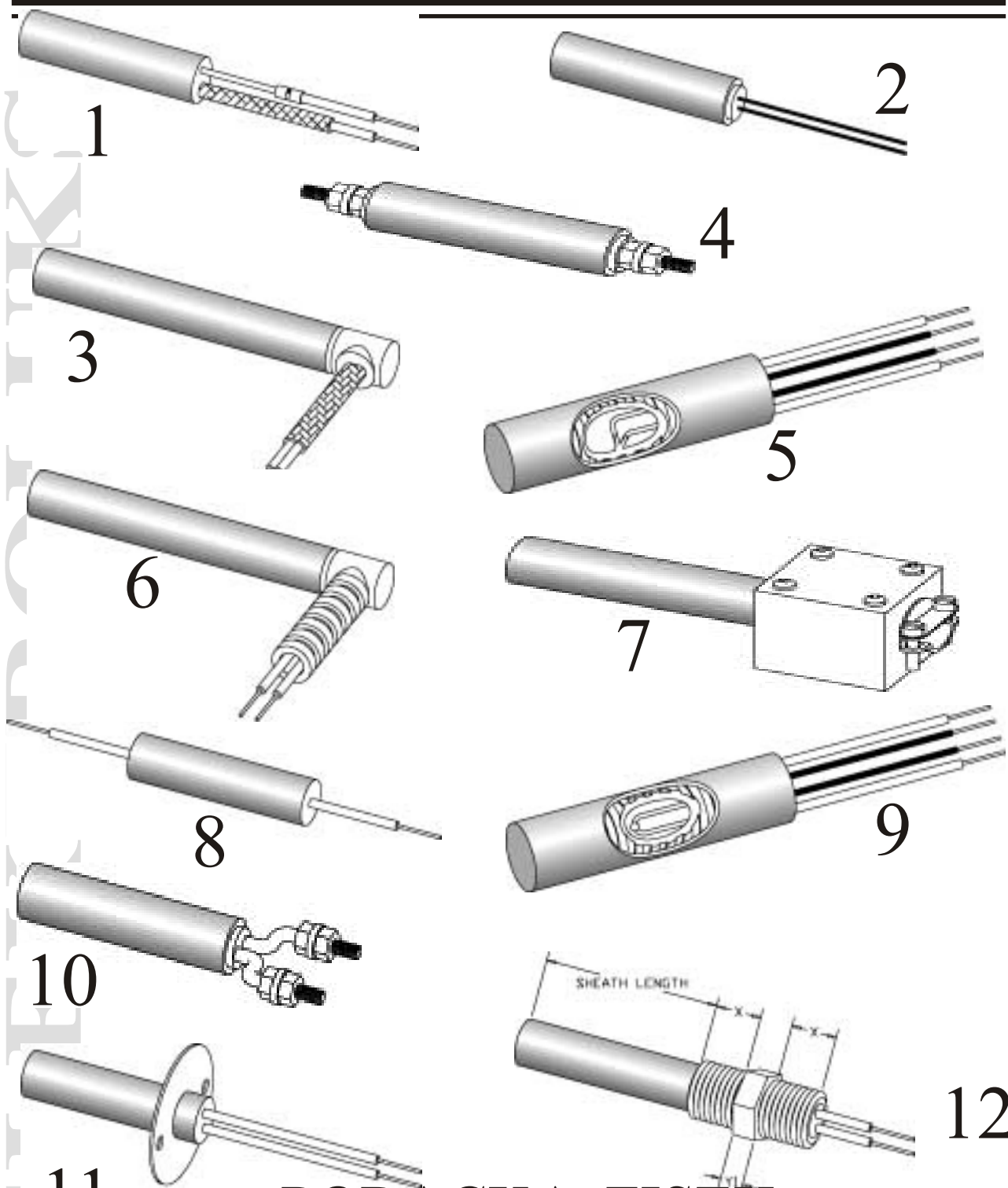

PORACKA FISEK
GREACI

803

Adresa: ul.Braka Mingovi 18, 7000 Bitola; tel: 047/203-330 ,203 900ul.A.Guslarot.1a 02/329 8 130 Skopje

www.elektroluks.com.mk. e-mail: elek-palenzo@mt.net.mk



Electrolux

INDUSTRIJA ZA EL. GREACI
GUMENI PROIZVODI

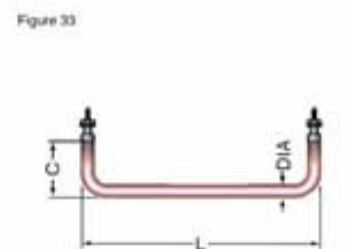
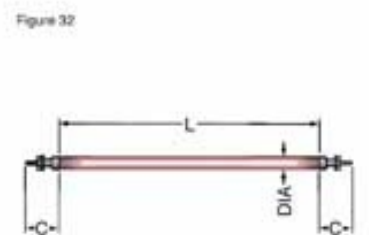
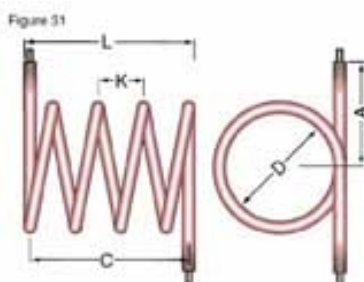
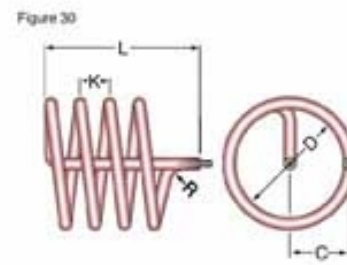
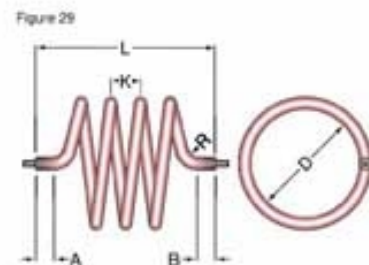
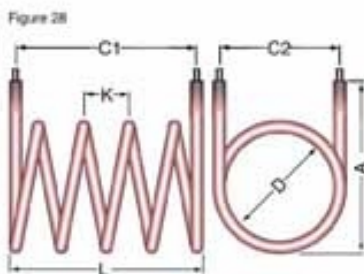
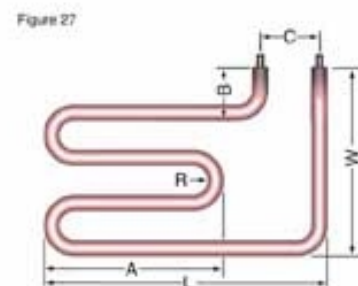
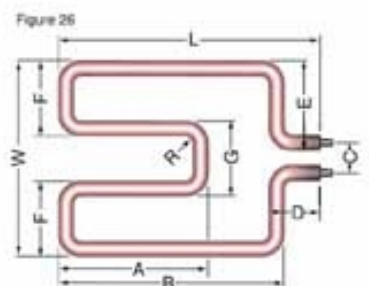
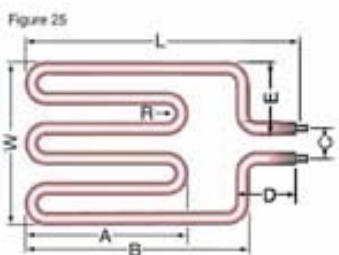
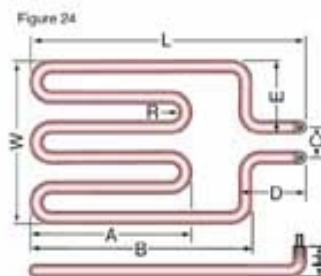
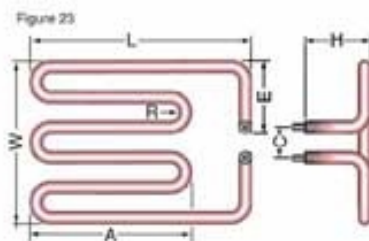
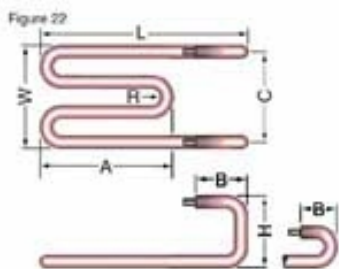

PORACKA CEVAST GREAC

804

Adresa: ul.Braka Mingovi 18, 7000 Bitola; tel: 047/203-330 ,203 900ul.A.Guslarot.1a 02/329 8 130 Skopje

www.elektroluks.com.mk. e-mail: elek-palenzo@mt.net.mk



ЕЛЕКТРОЛУКС

INDUSTRIJA ZA EL. GREACI
GUMENI PROIZVODI

ELEKTROLUKS

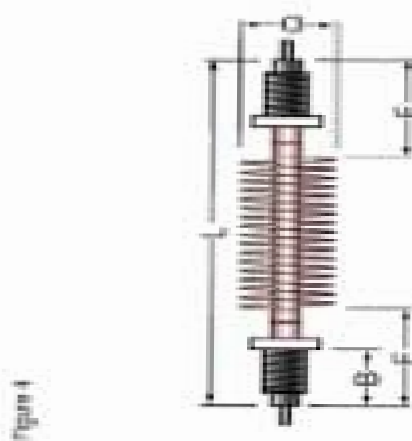
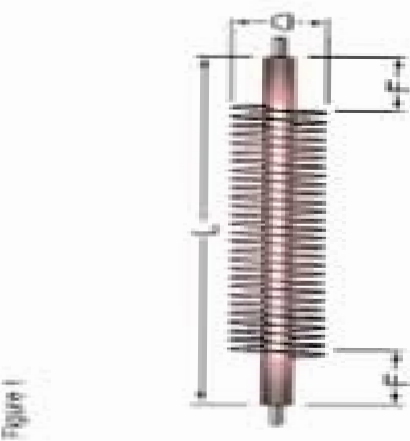
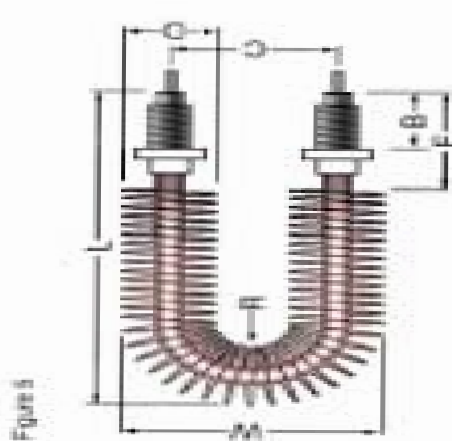
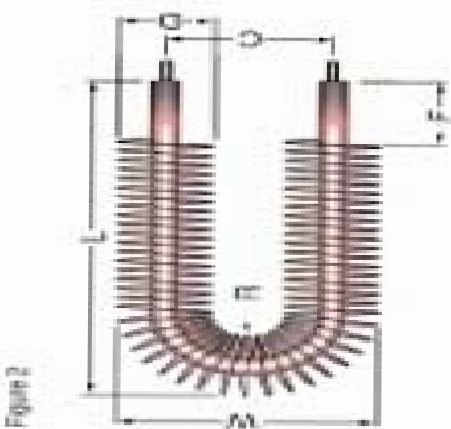
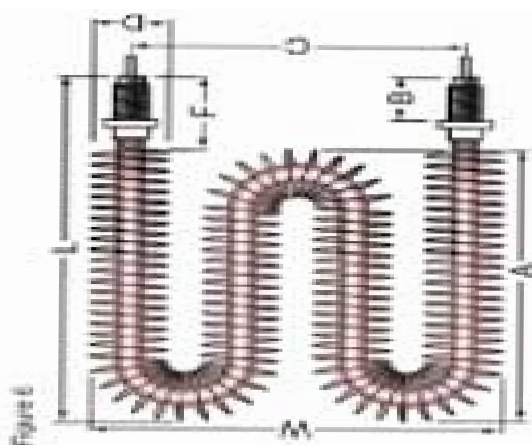
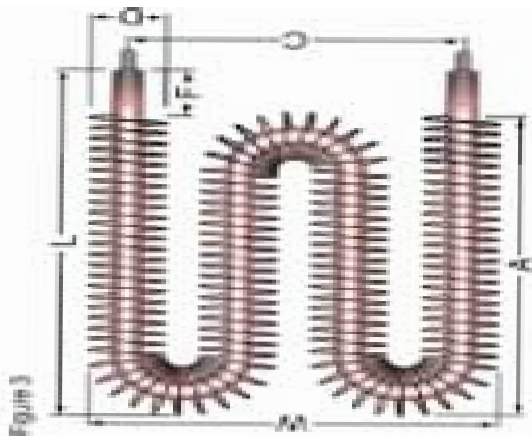

PORACKA VOZDUSNI GREACI 805

Adresa: ul.Braka Mingovi 18, 7000 Bitola; tel: 047/203-330 ,203 900ul.A.Guslarot.1a 02/329 8 130 Skopje
www.elektroluks.com.mk. e-mail: elek-palenzo@mt.net.mk



ЕЛЕКТРОЛУКС

INDUSTRIJA ZA EL. GREACI I
GUMENI PROIZVODI

Figure 10

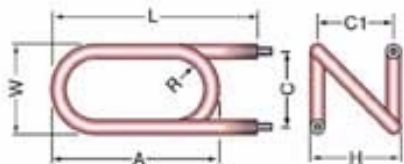

Figure 11

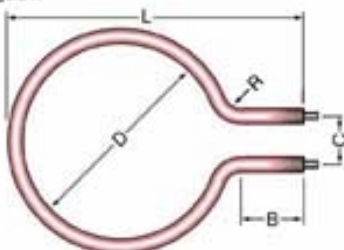

Figure 12

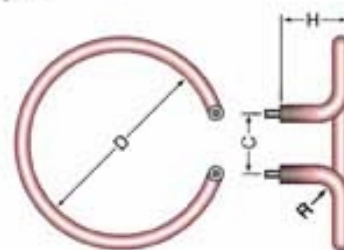

Figure 13

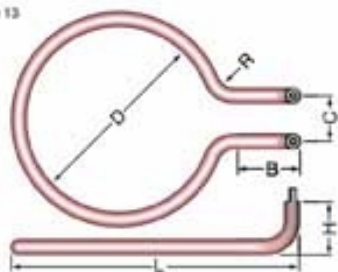

Figure 14

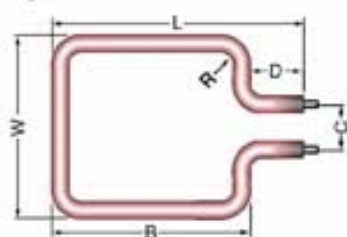

Figure 15

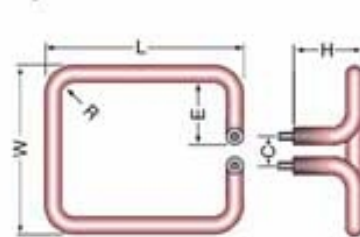

Figure 16

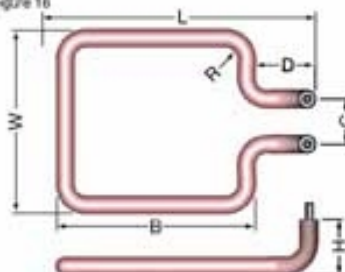

Figure 17

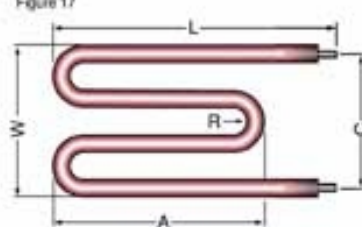

Figure 18

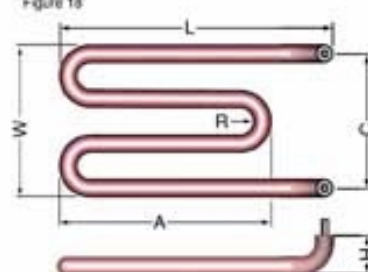

Figure 19

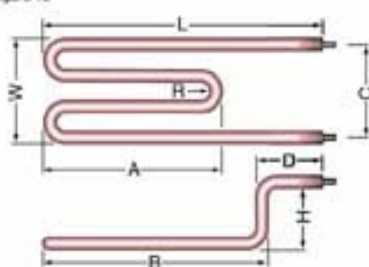

Figure 20

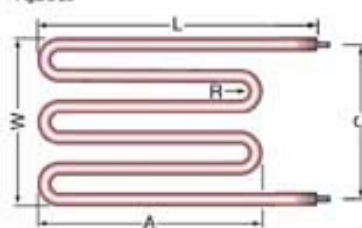
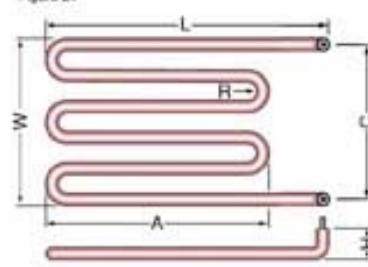

Figure 21



EL

PORACKA CEVAST GREAC

806

Adresa: ul.Braka Mingovi 18, 7000 Bitola; tel: 047/203-330 ,203 900ul.A.Guslarot.1a 02/329 8 130 Skopje

www.elektroluks.com.mk. e-mail: elek-palenzo@mt.net.mk



ЕЛЕКТРОЛУКС

INDUSTRIJA ZA EL. GREACI I
GUMENI PROIZVODI

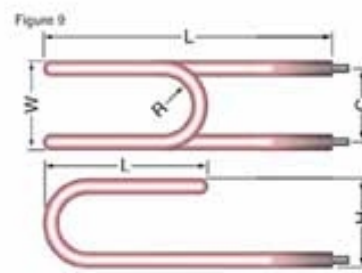
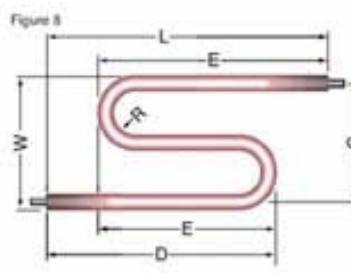
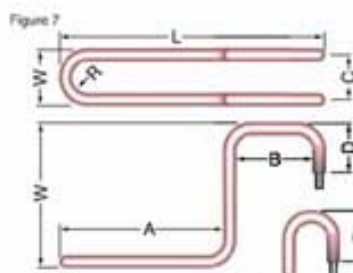
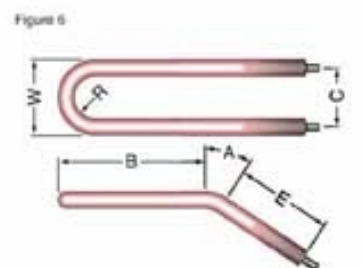
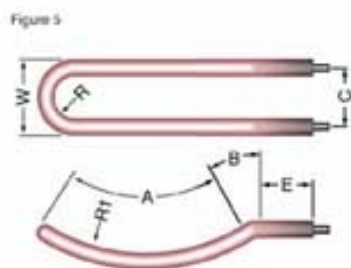
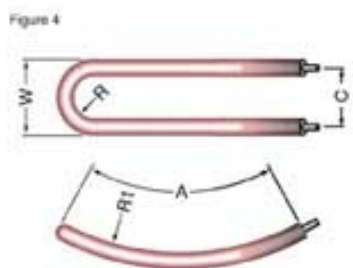
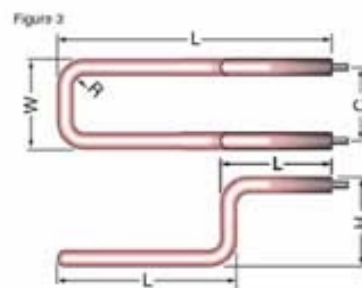
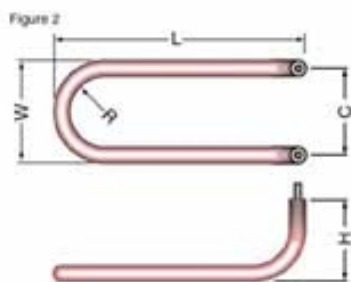
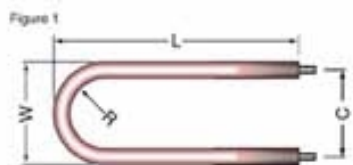

PORACKA CEVAST GREAC

807

Adresa: ul.Braka Mingovi 18, 7000 Bitola; tel: 047/203-330 ,203 900ul.A.Guslarot.1a 02/329 8 130 Skopje
www.elektroluks.com.mk. e-mail: elek-palenzo@mt.net.mk



ЕЛЕКТРОЛУКС

INDUSTRIJA ZA EL. GREACI I
GUMENI PROIZVODI

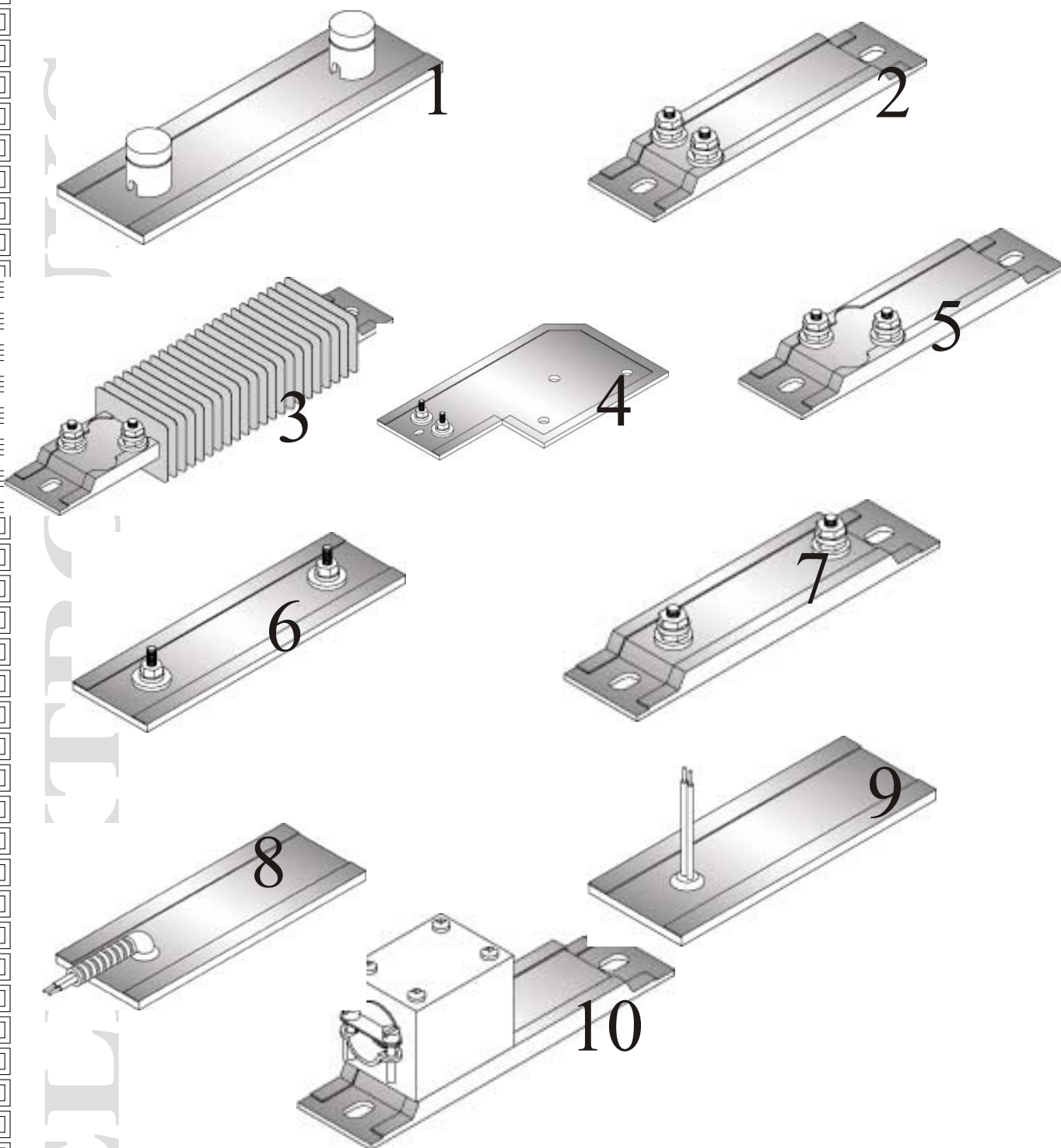

PORACKA PLOCEST GREAC 808

Adresa: ul.Braka Mingovi 18, 7000 Bitola; tel: 047/203-330 ,203 900ul.A.Guslarot.1a 02/329 8 130 Skopje

www.elektroluks.com.mk. e-mail: elek-palenzo@mt.net.mk