



Spare parts suitable for: **OFFCAR**

O

Suitable for Offcar

Spare parts suitable for modular ranges



G.E.V. Großküchen-Ersatzteil-Vertrieb GmbH
Robert-Koch-Straße 3a
82152 Planegg/Munich
Germany

Phone: +49 (0)89 745572-0
Fax: +49 (0)89 745572-83
order@gev-online.com
www.gev-online.com

Member of the  **GEV GROUP**

TABLE OF CONTENTS

Open tops (gas/electric)



page 4

Ovens (gas/electric)

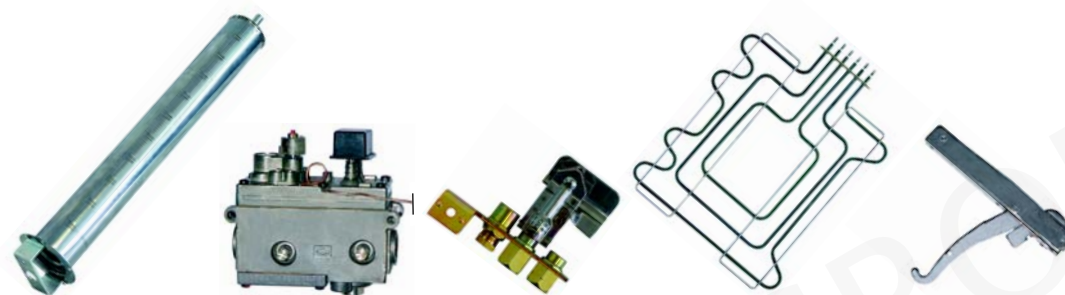

page 5

Fry tops (gas/electric), lava rock grills (gas)



page 6

Pasta cookers (gas/electric)



page 7

TABLE OF CONTENTS

Bains-marie (electric)



page 8

Fry tops (gas/electric)

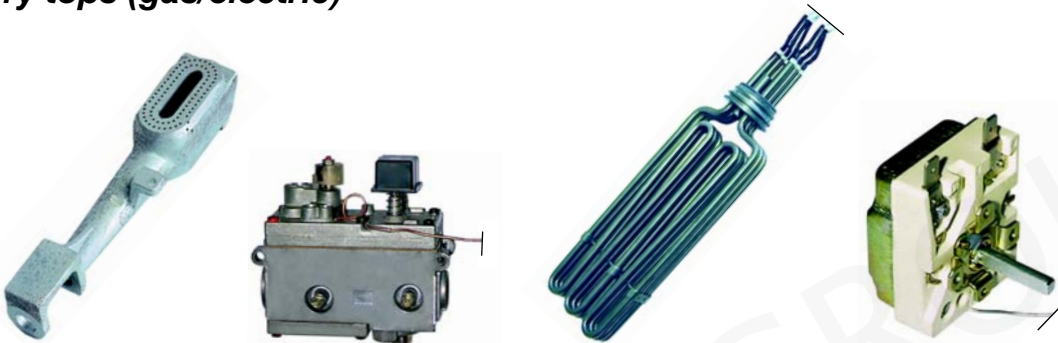

page 9

Tilting bratt pans (gas/electric)

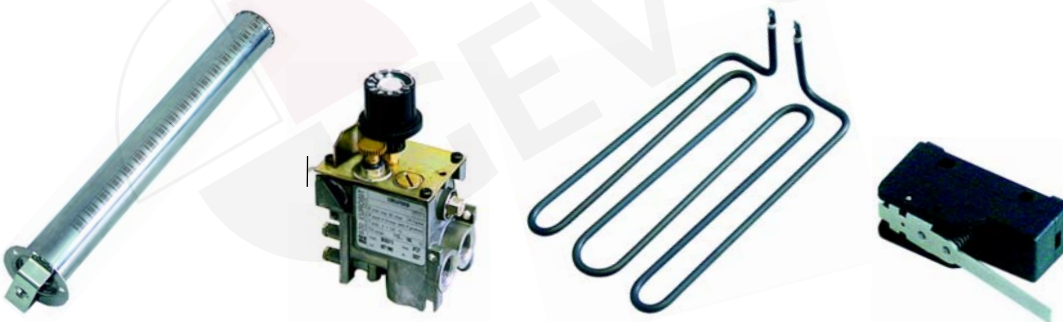

page 9

Boiling pans (gas/electric)



page 10

Open tops (gas)



Item	Order	Description	Model	OEM
1	105454	burner cover, 90mm		828125
2	105455	burner base		827345
3	105456	burner holder	LBG7__, CBG9__	827661 829589
4	105457	pilot burner holder		831841



Item	Order	Description	Model	OEM
1	105458	burner cover, 115 mm		828131
2	105459	burner base		827351
3	105456	burner holder	LBG7__, CBG9__	827661 829589
4	105460	pilot burner holder		831837

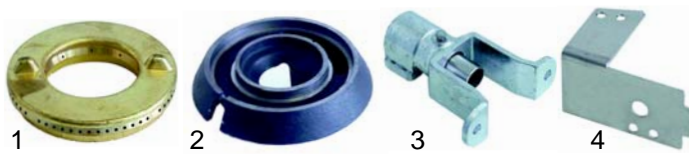

Item	Order	Description	Model	OEM
1	105461	burner cover, 135mm		828137
2	105462	burner base		827357
3	105463	burner holder	CBG9__	827665 829591
4	105464	pilot burner holder		831847



Item	Order	Description	Model	OEM
1	102039	thermocouple, 320mm		837233
1	102040	thermocouple, 600mm		837243
2	100041	pilot burner	LBG7__, CBG9__	837201
3	101060	solenoid coil		835337



Item	Order	Description	Model	OEM
1	101397	gas tap, PEL215		401101
2	110980	knob		401405



Item	Order	Description	Model	OEM
1	105465	burner tray, 90	CBG9__	440081
2	105466	burner tray, 115/135		440083
3	105467	burner tray	CBG7	440059

Open tops (solid top)



Item	Order	Description	Model	OEM
1	105468	burner		827981
2	101397	gas tap PEL21	TPG7__, TPG9__	401101
3	110980	knob		401405



Item	Order	Description	Model	OEM
1	100076	pilot burner		863981
2	102040	thermocouple 600mm	TPG7__, TPG9__	837243
3	100701	electrode		835915



Item	Order	Description	Model	OEM
1	100013	piezoelectric igniter	TPG7__, TPG9__	835733
2	100176	ignition cable		835905

Suitable for Offcar

Open tops (electric)

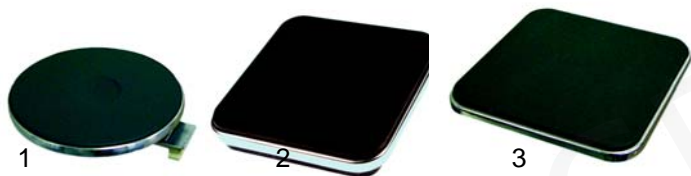

Item	Order	Description	Model	OEM
1	490020	2600W/230V (220mm)	CTE7__	843412
2	490066	2600W/230V (220x220mm)	CQE7__	846405
3	490070	3000W/230V (300x300mm)	CQE9__	843401



Item	Order	Description	Model	OEM
1	102102	Minisit sensor		837111
2	101053	solenoid coil Minisit	CBG__	837119
3	100026	ignition cable		835901



Item	Order	Description	Model	OEM
1	300025	7-position switch		843751
2	110981	knob	CTE7__	401441
3	359132	signal element	CQE7__	862331
4	359126	insert lamp holder	CQE9__	862333

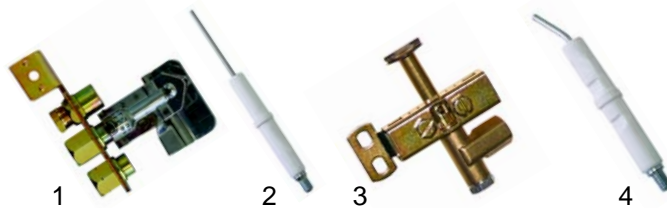

Item	Order	Description	Model	OEM
1	100076	pilot burner	CBG__ (new)	863981
2	100701	electrode		835915
3	100046	pilot burner	CBG__ (old)	837221
4	100706	electrode		835911

Ovens (gas)

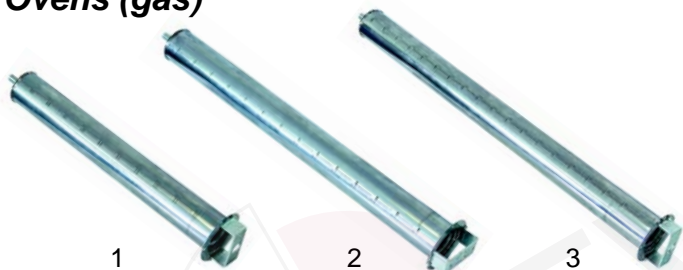

Item	Order	Description	Model	OEM
1	105469	burner	CBG71__, CBG72__	841111
2	105470	burner	CBG91__, CBG92__, CBG94__	841211
3	105471	burner	GroßOven Maxi	841219

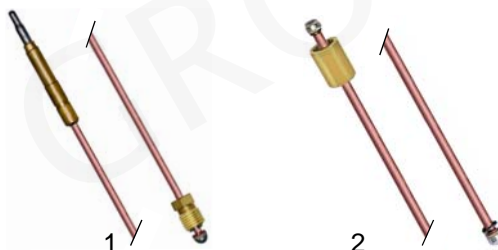

Item	Order	Description	Model	OEM
1	102039	thermocouple, 320mm		837233
1	102043	thermocouple, 1000mm	CBG__	837253
2	102013	extension 500mm		837261

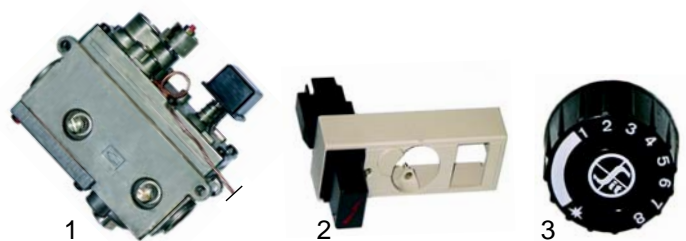

Item	Order	Description	Model	OEM
1	101132	Minisit controller		835701
2	101136	piezoelectric igniter and cover	CBG__	835729
3	110068	knob		835721

Ovens (electric)

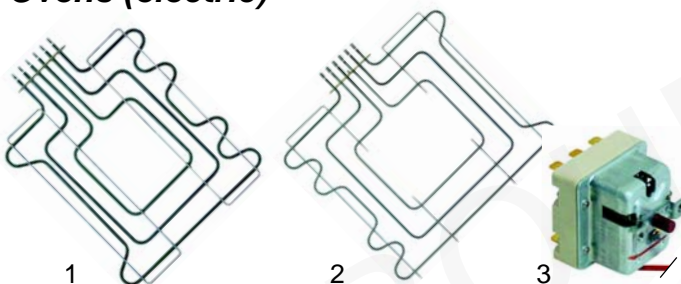

Item	Order	Description	Model	OEM
1	416666	1800W/230V	CTE71__, CTE72__, CQE71__, CQE72__	843641
2	416667	2750W/230V	CQE91__, CQE92__	843645
3	375228	safety thermostat		843737

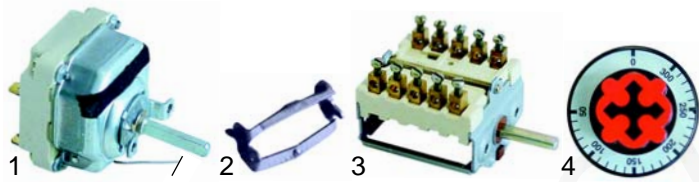

Item	Order	Description	Model	OEM
1	375362	thermostat 300°C		843735
2	550060	retainer	CTE71__, CTE72__, CQE71--, CQE72__	843753
3	300115	switch	CQE91__, CQE92__	843745
4	110990	knob		401421

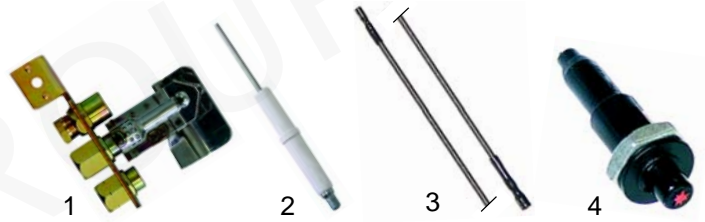

Item	Order	Description	Model	OEM
1	100076	pilot burner		863981
2	100701	electrode		835915
3	100140	ignition cable	FTG__	835909
4	100013	piezoelectric igniter		835733



Item	Order	Description	Model	OEM
1	359132	signal element (green)		862331
1	359130	signal element (clear)	CTE71__, CTE72__, CQE71--, CQE72__	862337
2	359126	insert lamp holder (green)	CQE91__, CQE92__	862333
3	359225	insert lamp holder (clear)		862339

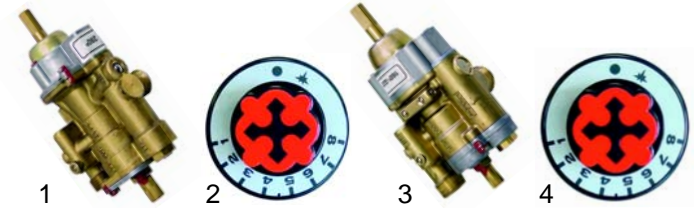

Item	Order	Description	Model	OEM
1	101172	thermostat PEL25	FTG7__	401251
2	110982	knob		401415
3	101076	thermostat PEL24	FTG9__	401201
4	110983	knob		401411

Ovens (mechanical)



Item	Order	Description	Model	OEM
1	700006	hinge/right		844581
2	700007	hinge/left		844583
3	700001	counter part	universal	844589
4	900256	door seal		844453

Fry tops (gas)

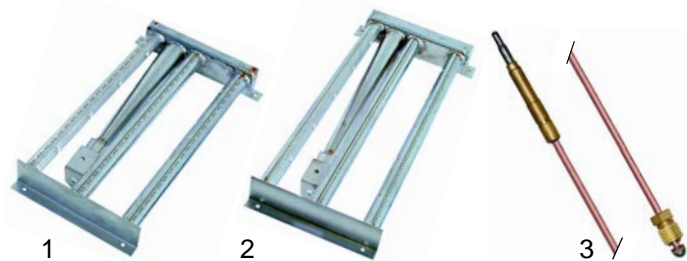

Item	Order	Description	Model	OEM
1	105472	burner	FTG7__	841251
2	105473	burner	FTG9__	841261
3	102039	thermocouple	FTG__	837233

Fry tops (electric)

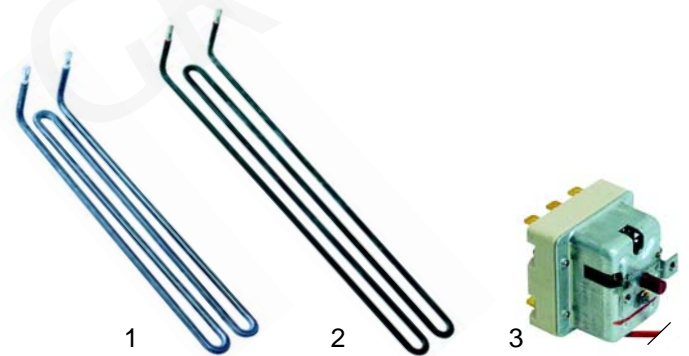

Item	Order	Description	Model	OEM
1	416668	1600W/230V	FTE7__	843627
2	416669	2000W/230V	FTE9__	843629
3	375228	safety thermostat	FTE__	843737

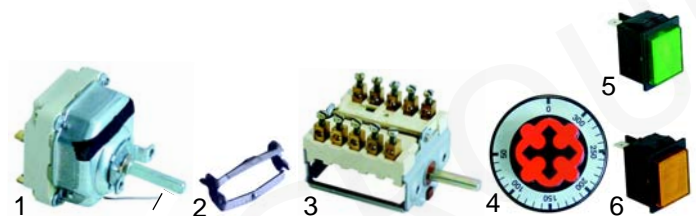

Item	Order	Description	Model	OEM
1	375362	thermostat 300°C		843735
2	550060	retainer		843753
3	300115	switch		843745
4	110990	knob	FTG__	401421
5	359157	signal lamp (green)		849461
6	359156	signal lamp (yellow)		849457

Suitable for Ofcar

Lava rock grills



Item	Order	Description	Model	OEM
1	105474	burner	GRL7__	865851
2	105475	Brnner	GRL9__	865861

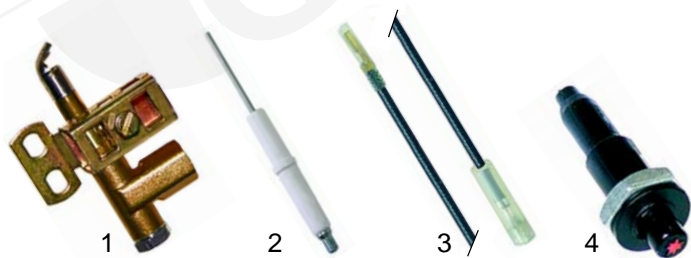

Item	Order	Description	Model	OEM
1	100041	pilot burner		865881
2	100701	electrode	GRL7__	835915
3	100176	ignition cable, 1000mm	GRL9__	835905
4	100013	piezoelectric igniter		835733



Item	Order	Description	Model	OEM
1	102039	thermocouple 320		837233
2	101397	gas tap PEL21	GRL7__	401101
3	110980	knob	GRL9__	401405

Pasta cookers (gas)

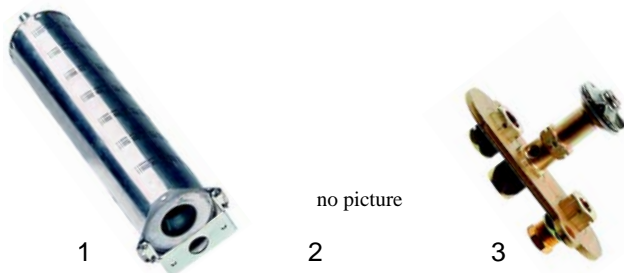

Item	Order	Description	Model	OEM
1	105476	burner	CPG7__	898963
2	105477	burner	CPG9__	898961
3	100056	pilot burner	(old)	898969



Item	Order	Description	Model	OEM
1	100041	pilot burner	(new)	899969
2	100701	electrode		835915
3	100176	ignition cable	CPG7__	835905
4	100013	piezoelectric igniter	CPG9__	835733



Item	Order	Description	Model	OEM
1	102043	thermocouple 1000		837253
2	101086	gas tap PEL22	CPG7__	401151
3	110985	knob	CPG9__	401401

Pasta cookers (electric)



Item	Order	Description	Model	OEM
1	416670	2000W/230V (side)	CPE730/760	898981
2	416671	2000W/230V (in centre)		898983
3	416685	2800W/230V (side)	CPE745/945,	898985
4	416686	2800W/230V (in centre)	CPE990	898986

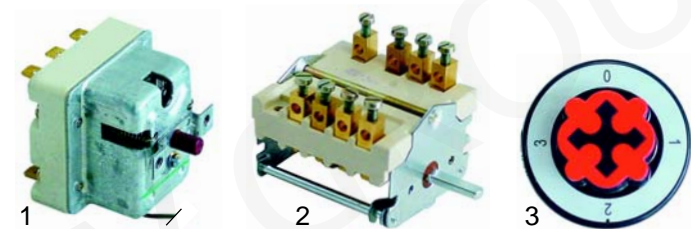

Item	Order	Description	Model	OEM
1	375368	safety thermostat		898979
2	300145	switch	CPE__	898973
3	110986	knob		401451

Fryers (gas)



Item	Order	Description	Model	OEM
1	359132	signal element (green)	CPE__	862331
1	359130	signal element (clear)		862337
2	359126	insert lamp holder (green)		862333
3	359225	insert lamp holder (clear)		862339



Item	Order	Description	Model	OEM
1	105478	burner/right	FRG__	862511
2	105479	burner/left		862513
3	105480	burner/in centre		862519

Pasta cookers (mechanical)



Item	Order	Description	Model	OEM
1	693105	inlet tap	CPE__, CPG__	898871
2	693106	handle		898873

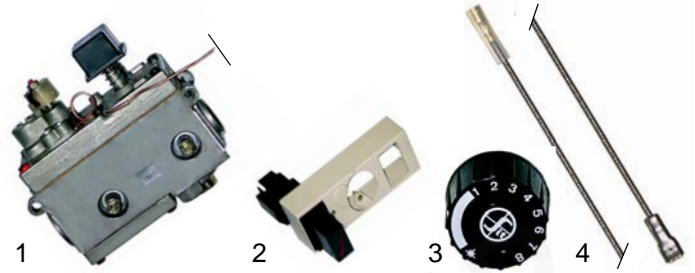

Item	Order	Description	Model	OEM
1	101135	Minisit controller		863811
2	101136	cover lamp with piezoelectric igniter	FRG__	835729
3	110068	knob		835721
4	100026	ignition cable		863901

Bains-marie (electric)

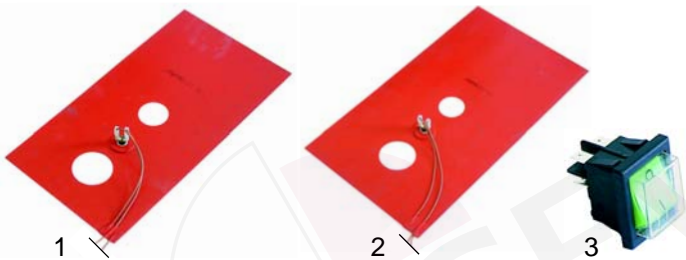

Item	Order	Description	Model	OEM
1	416687	1000W/230V	BME7__	843613
2	416688	1350W/230V	BME9__	843611
3	300125	switch, 2-pole	BME__	849451

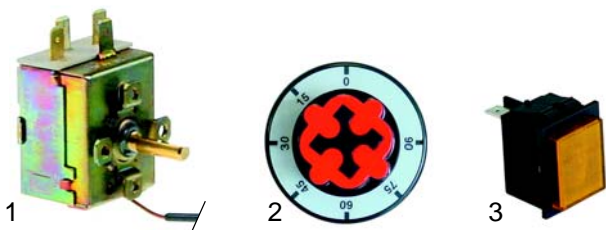

Item	Order	Description	Model	OEM
1	375564	thermostat 90°C		843791
2	110987	knob	BME__	401431
3	359156	signal lamp		849457



Item	Order	Description	Model	OEM
1	100046	pilot burner	FRG__	837221
2	100706	electrode		835911
3	102041	thermocouple 600mm		837243

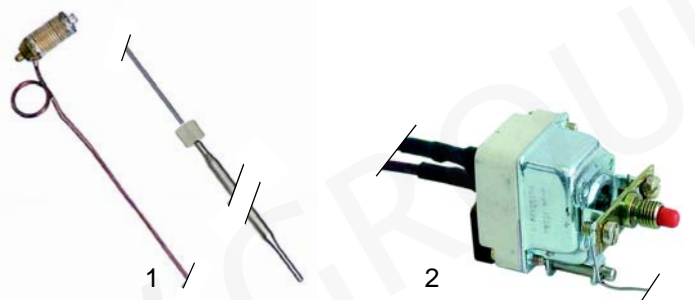

Item	Order	Description	Model	OEM
1	102118	Minisit sensor	FRG__	863801
2	375376	safety thermostat 230°C		862133

Fryers (electric)



Item	Order	Description	Model	OEM
1	416063	6800W/3 phases 230V	FRE7202, FRE9202	862033
2	416070	10200W/3 phases 230V	FRE715/730	862029
3	416059	15000W/3 phases 230V	FRE720/740, FRE920/940	862021

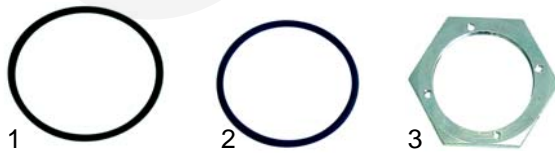

Item	Order	Description	Model	OEM
1	532502	O-ring, 60mm		862053
2	532503	O-ring, 55mm	universal	862051
3	550662	nut		862047

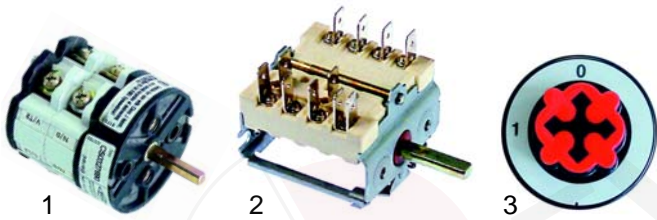

Item	Order	Description	Model	OEM
1	345817	switch	FRE720/740, FRE920/940	862325
2	300166	switch	FRE7202, FRE9202,	862317
3	110988	knob	FRE715/730	401469

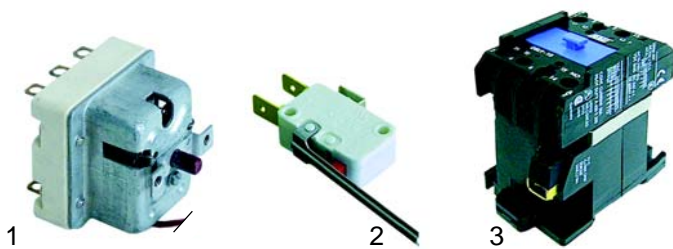

Item	Order	Description	Model	OEM
1	375375	safety thermostat		862123
2	345254	micro switch	universal	862311
3	380204	protection		862329



Item	Order	Description	Model	OEM
1	375261	thermostat		862115
2	110989	knob		401461
3	359132	signal element/green	universal	862331
3	359130	signal element/clear		862337
4	359126	insert lamp holder/green		862333
5	359225	insert lamp holder/clear		863339

Tilting bratt pans (gas)



Item	Order	Description	Model	OEM
1	105481	burner	BRG750/750I	FX-30400060
2	105482	burner	BRG990/990I	FX-30400050
3	101125	Eunosit controller	BRG__	FX-30100080



Item	Order	Description	Model	OEM
1	100046	pilot burner		837221
2	100706	electrode	BRG__	835911
3	100013	piezoelectric igniter		835733
4	102043	thermocouple		837253

Tilting bratt pans (electric)

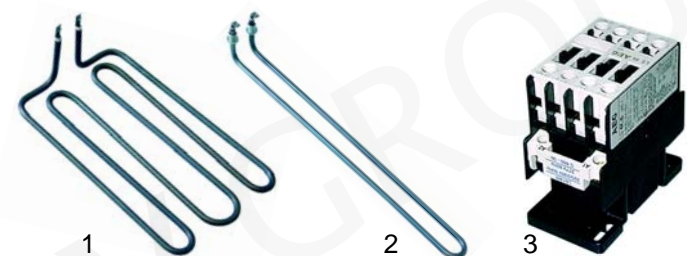

Item	Order	Description	Model	OEM
1	416692	2900W/230V	BRE750/750I	FX-40400082
2	416693	1650W/230V	BRE990/990I	FX-40400084
3	380244	contactor	BRE__	FX-40100023

Suitable for Ofcar

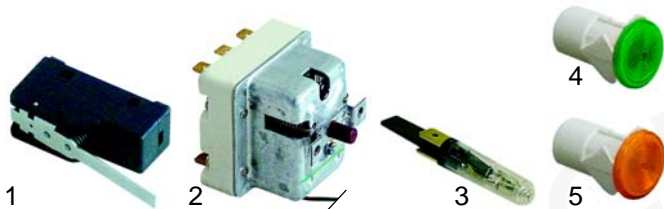

Item	Order	Description	Model	OEM
1	345772	limit switch		FX-40100007
2	375366	safety thermostat		FX-40100062
3	359133	signal element (green)	BRE750I,	-
3	359131	signal element (clear)	BRE990I,	FX-40200154
4	359262	insert lamp holder (green)	BRE990I	FX-40200152
5	359260	insert lamp holder (yellow)		FX-40200150



Item	Order	Description	Model	OEM
1	375270	thermostat		FX-40100042
2	300080	switch		FX-40100006
3	110990	knob		401421

Tilting bratt pans (mechanical)



Item	Order	Description	Model	OEM
1	693107	inlet tap	BRG7__, BRE7__	FX-30200008
2	693108	inlet tap	BRG9__, BRE9__	FX-30200005



Item	Order	Description	Model	OEM
1	693109	nut		FX-SC022-00
2	693110	threaded rod		FX-SMB0128-00
3	693111	extension	BRG7__, BRE7	FX-SMB0130-00
4	693112	bearing, complete		FX-20400012
5	693113	hand wheel		FX-SMB0136-00

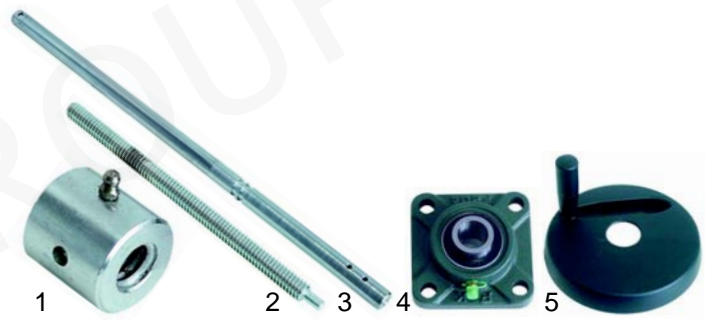

Item	Order	Description	Model	OEM
1	693109	nut		FX-SC0022-00
2	693110	threaded rod		FX-SMB0128-00
3	693114	extension	BRG9__, BRE9__	FX-SMB0630-00
4	693112	bearing, complete		FX-20400012
5	693115	hand wheel		FX-SMB0636-00

Boiling pans (gas)

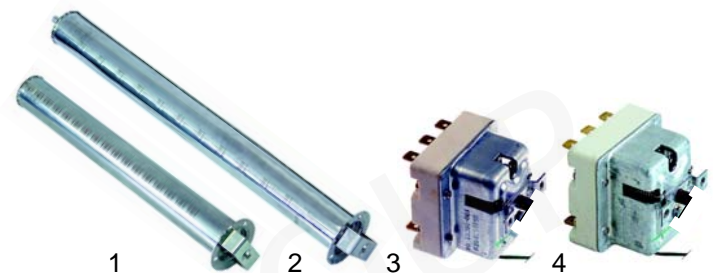

Item	Order	Description	Model	OEM
1	105481	burner	PQG750D/I	FX-30400060
2	105482	burner	PQG910D/I, PQG915D/I	FX-30400050
3	375364	safety thermostat	PQG750I	FX-40100041
4	375366	safety thermostat	PQG910I/915I	FX-40100062

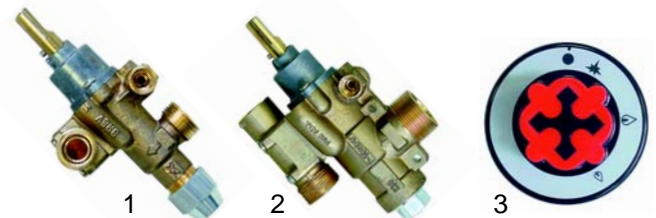

Item	Order	Description	Model	OEM
1	101892	gas tap PEL22	PQG910I/915I	FX-30100009
2	101893	gas tap PEL23	PQG910D/I, PQG915D/I	FX-30100003
3	110985	knob	universal	401401



Item	Order	Description	Model	OEM
1	100046	pilot burner		837221
2	100706	electrode	PQG750D/I, PQG910D/I,	835911
3	100013	piezoelectric igniter	PQG915D/I	835733
4	102043	thermocouple		837253

Boiling pans (electric)



Item	Order	Description	Model	OEM
1	416834	9000 W/3 phases 230 V	PQE750I/915I	FX-40400042
2	416835	8000 W/3 phases 230 V	PQE910I	FX-40400040
3	510408	gasket (O-ring)	PQE_	FX-10500100
4	380244	contactor		FX-40100023

Boiling pans (mechanical)



Item	Order	Description	Model	OEM
1	541062	manometer		FX-30300022
2	540639	extension	PQG_I,	FX-10400058
3	540823	safety valve	PQE_I	FX-30300014
4	540835	end cap, 3/4"		FX-10400061

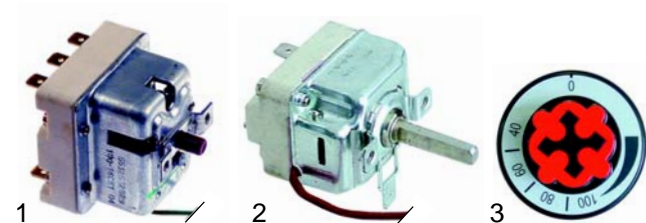

Item	Order	Description	Model	OEM
1	375364	safety thermostat		FX-40100041
2	375363	thermostat	PQE_	FX-40100050
3	110991	knob		401483



Item	Order	Description	Model	OEM
1	540659	testing tap	PQ_I	FX-30200050
2	540276	drain cock, 1 1/2"	PQ_7_I	FX-30200196
3	540649	drain cock, 2"	PQ-9_I	FX-30200198



Item	Order	Description	Model	OEM
1	300167	switch		FX-40100004
2	110992	knob		401477
3	359133	signal element (green)	PQE_	-
3	359131	signal element (yellow)		FX-40200154
4	359262	insert lamp holder (green)		FX-40200150
5	359260	insert lamp holder (yellow)		FX-40200152



Item	Order	Description	Model	OEM
1	540954	nipple 1 1/2"		FX-10400009
2	540955	rosette 1 1/2"	PQ7	FX-10200004
3	540956	gasket 1 1/2"		FX-10500062



Item	Order	Description	Model	OEM
1	540957	nipple 2"		FX-10400006
2	540958	rosette 2"	PQ9	FX-10200002
3	540959	gasket 2"		FX-10500060

