

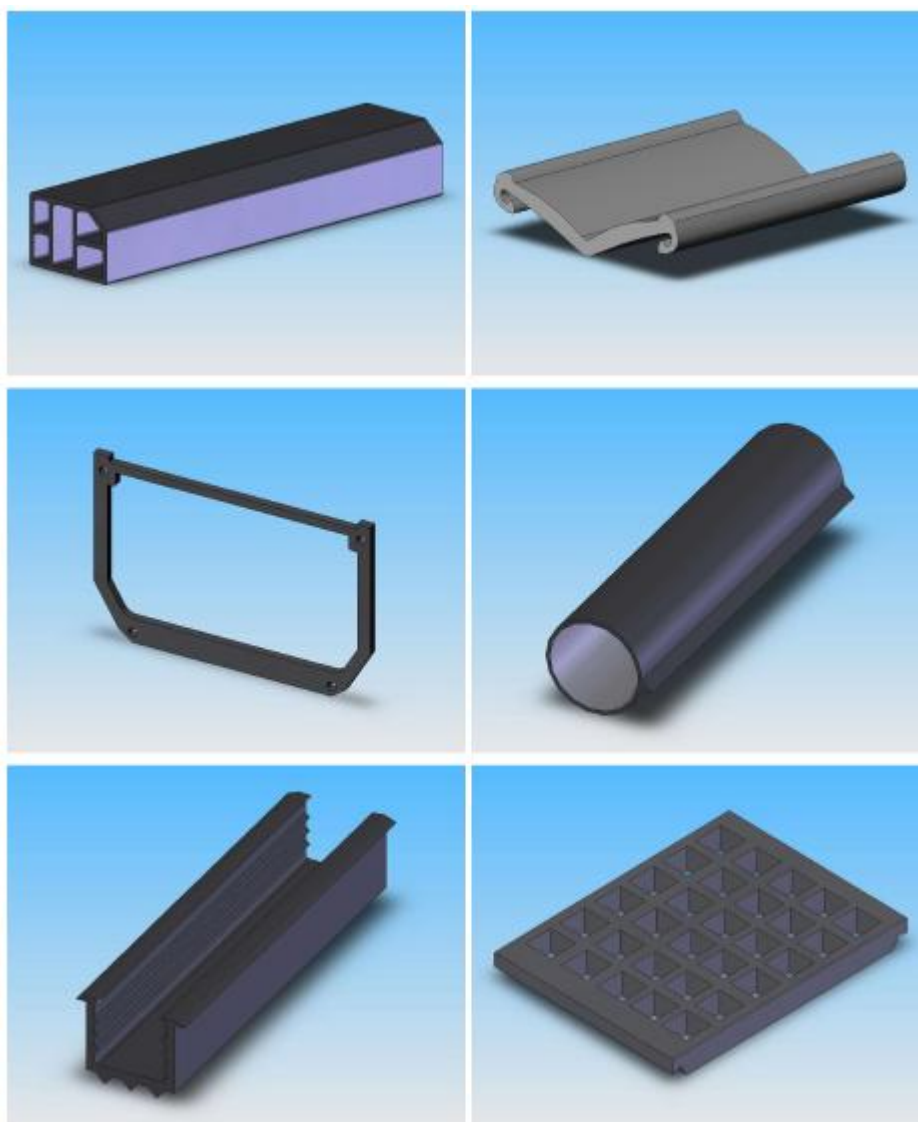

KATALOG ZA PROIZVODI OD GUMA



TEL: Bt - 00389 47 203 330 , Sk – 00389 02 3298130

FAKS: Bt - 00389 47 203 900 , Sk - 00389 02 3298130 E-mail : electrolux@t-home.mk

Veb-sajt: www.electrolux.mk

www.elektroluks.mk

Ulica:Bitola-Braka Mingovi Br.18, Skopje-Apostol Guslarot br. 1a



KATALOG ZA PROIZVODI OD GUMA



"A" EKSTRUDIRANI PROIZVODI

A1 Pecati na Vrti i Prozori

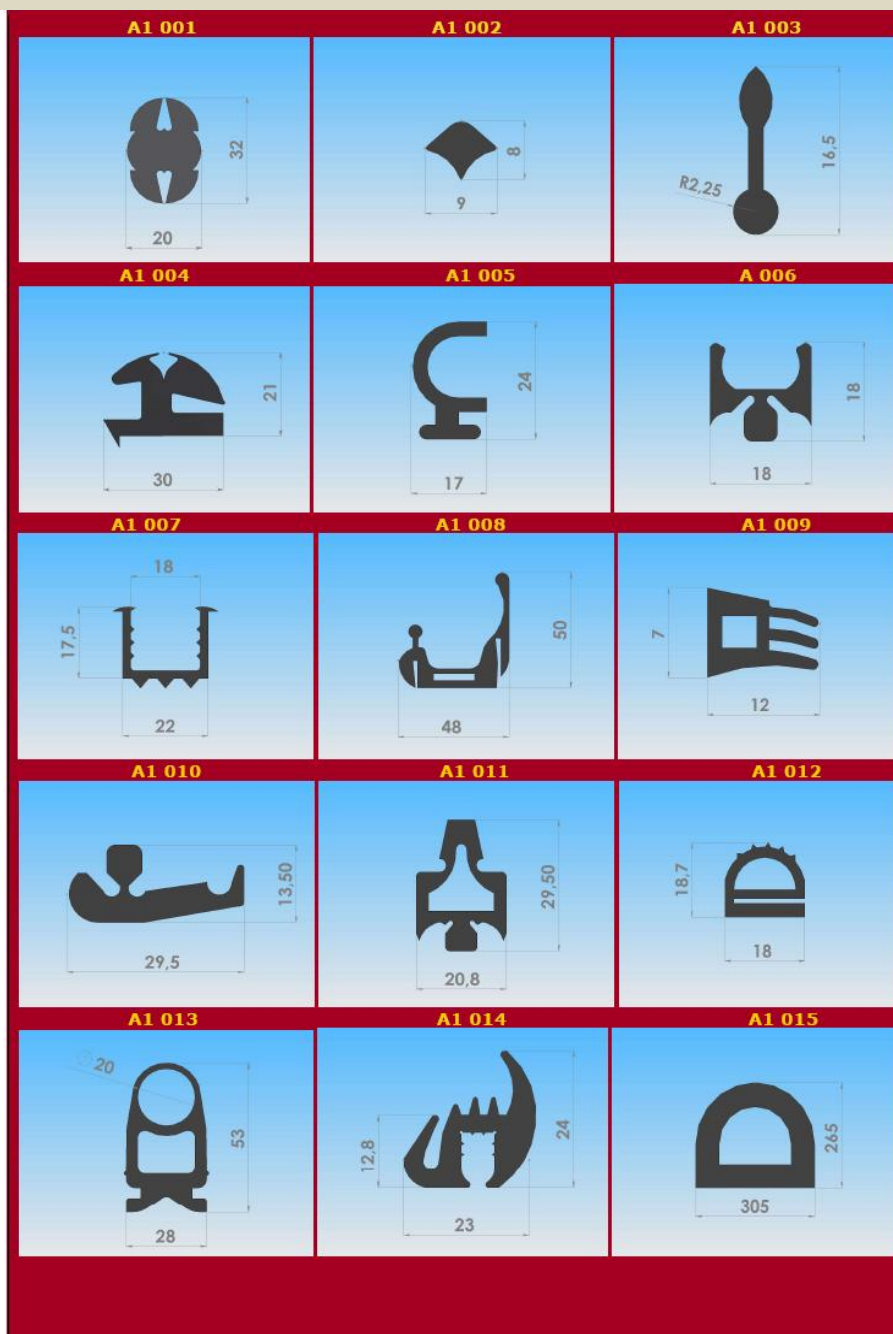

TEL: Bt - 00389 47 203 330 , Sk - 00389 02 3298130

FAKS: Bt - 00389 47 203 900 , Sk - 00389 02 3298130 E-mail : electrolux@t-home.mk

Veb-sajt: www.electrolux.mk

www.elektroluks.mk

Ulica:Bitola-Braka Mingovi Br.18, Skopje-Apostol Guslarot br. 1a



KATALOG ZA PROIZVODI OD GUMA

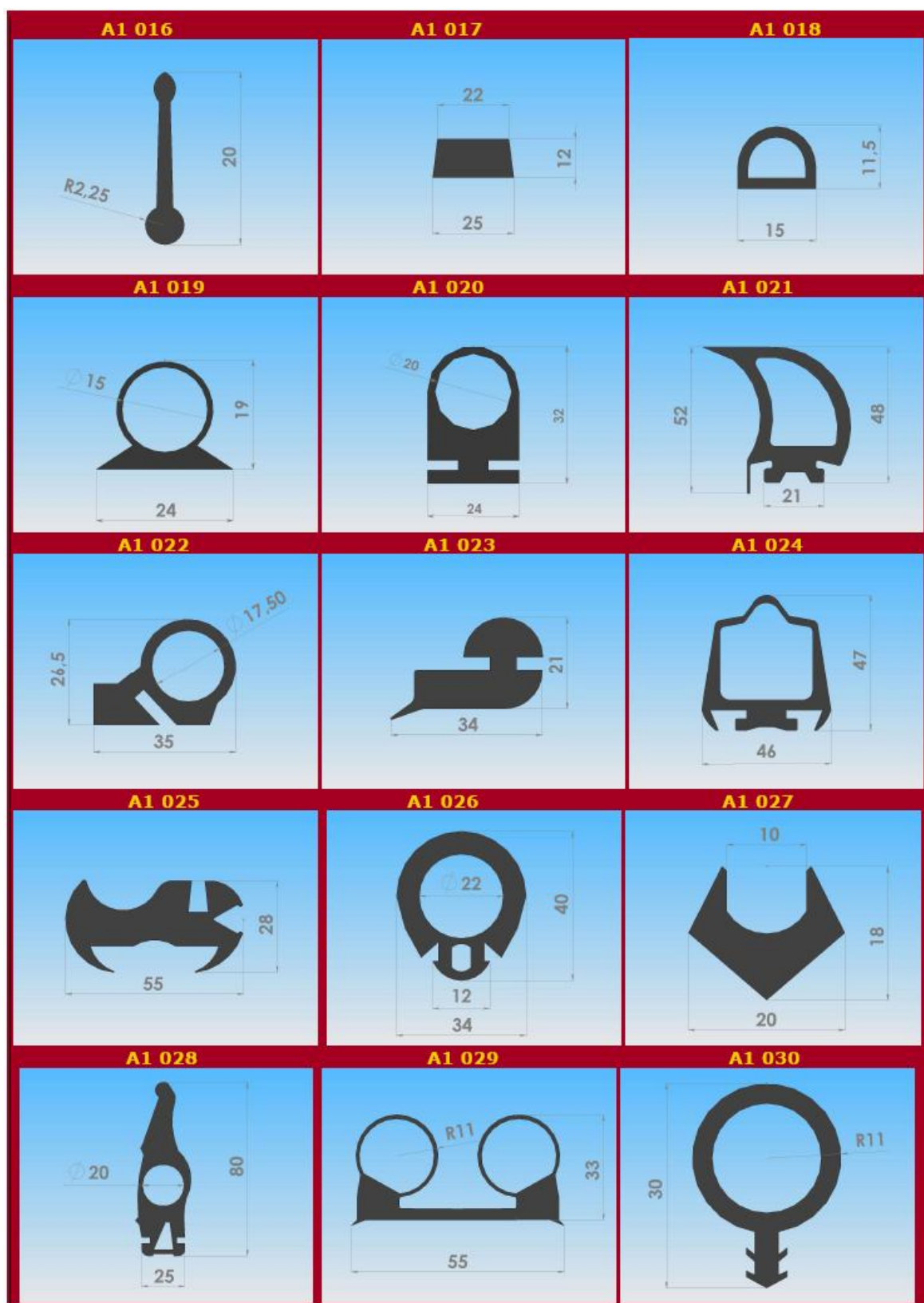

TEL: Bt - 00389 47 203 330 , Sk - 00389 02 3298130

FAKS: Bt - 00389 47 203 900 , Sk - 00389 02 3298130 E-mail : electrolux@t-home.mk

Veb-sajt: www.electrolux.mk

www.elektroluks.mk

Ulica:Bitola-Braka Mingovi Br.18, Skopje-Apostol Guslarot br. 1a



KATALOG ZA PROIZVODI OD GUMA

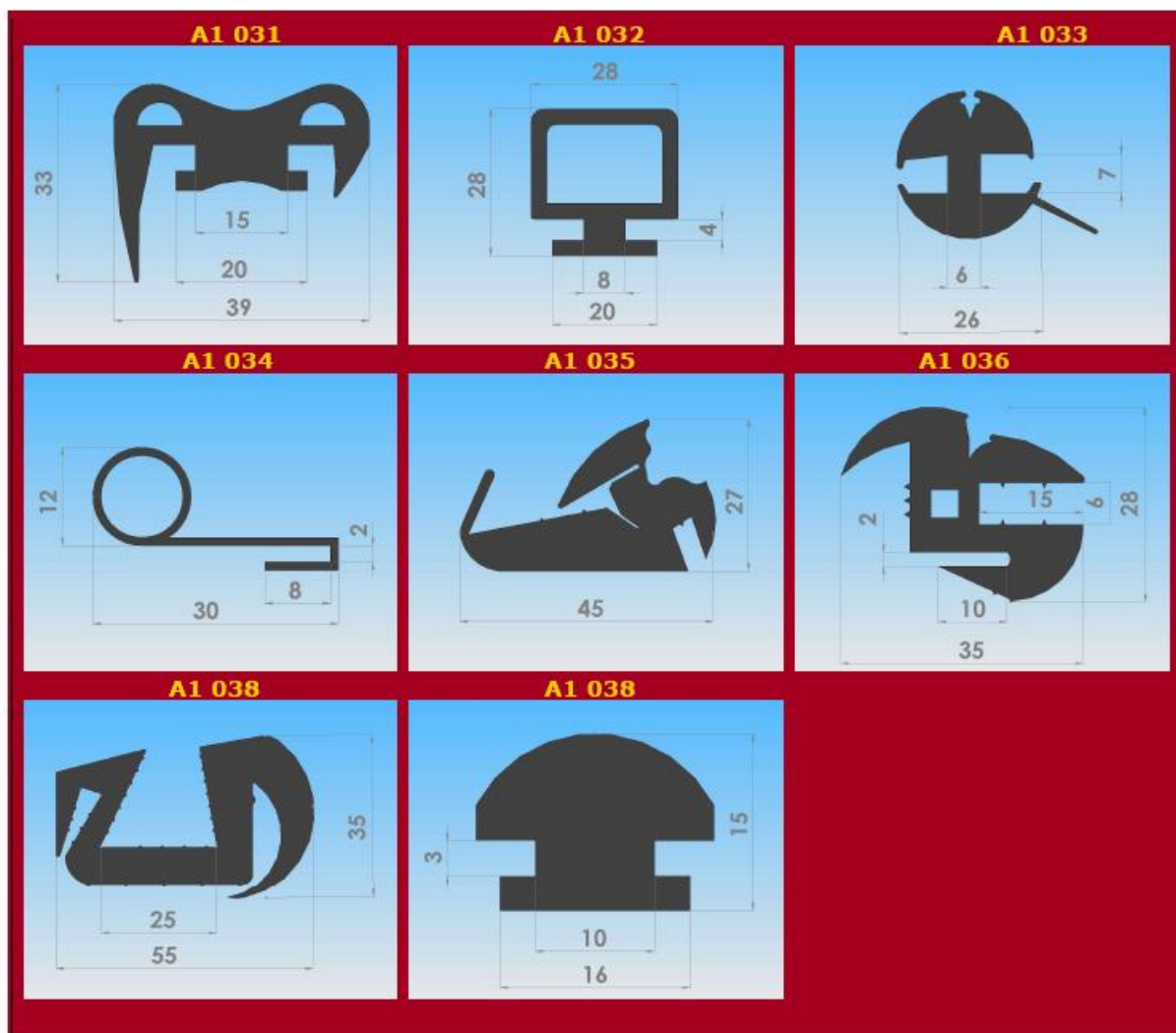

TEL: Bt - 00389 47 203 330 , Sk - 00389 02 3298130

FAKS: Bt - 00389 47 203 900 , Sk - 00389 02 3298130 E-mail : electrolux@t-home.mk

Veb-sajt: www.electrolux.mk

www.elektroluks.mk

Ulica:Bitola-Braka Mingovi Br.18, Skopje-Apostol Guslarot br. 1a



KATALOG ZA PROIZVODI OD GUMA



A2 "U" Profili



TEL: Bt - 00389 47 203 330 , Sk - 00389 02 3298130

FAKS: Bt - 00389 47 203 900 , Sk - 00389 02 3298130 E-mail : electrolux@t-home.mk

Veb-sajt: www.electrolux.mk

www.elektroluks.mk

Ulica:Bitola-Braka Mingovi Br.18, Skopje-Apostol Guslarot br. 1a



KATALOG ZA PROIZVODI OD GUMA



A3 "P" Profili

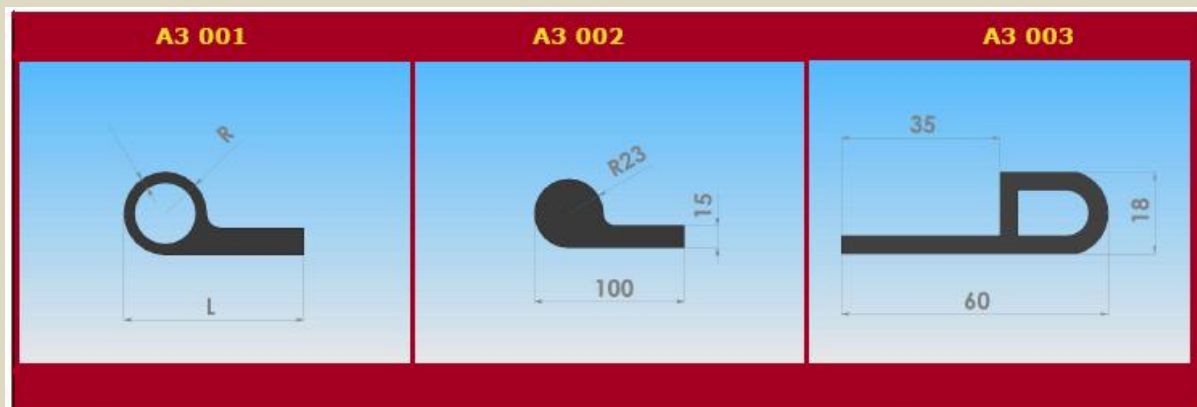

A4 Diletaciski profilni traki

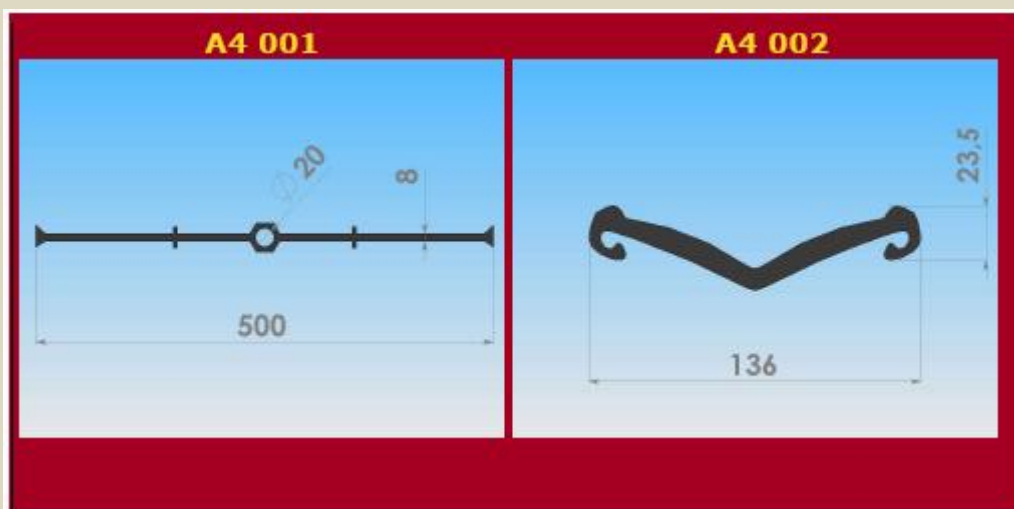

TEL: Bt - 00389 47 203 330 , Sk - 00389 02 3298130

FAKS: Bt - 00389 47 203 900 , Sk - 00389 02 3298130 E-mail : electrolux@t-home.mk

Veb-sajt: www.electrolux.mk

www.elektroluks.mk

Ulica:Bitola-Braka Mingovi Br.18, Skopje-Apostol Guslarot br. 1a



KATALOG ZA PROIZVODI OD GUMA



A5 Branici



TEL: Bt - 00389 47 203 330 , Sk – 00389 02 3298130

FAKS: Bt - 00389 47 203 900 , Sk - 00389 02 3298130 E-mail : electrolux@t-home.mk

Veb-sajt: www.electrolux.mk

www.elektroluks.mk

Ulica:Bitola-Braka Mingovi Br.18, Skopje-Apostol Guslarot br. 1a



KATALOG ZA PROIZVODI OD GUMA



A6 Razni profilni pecati

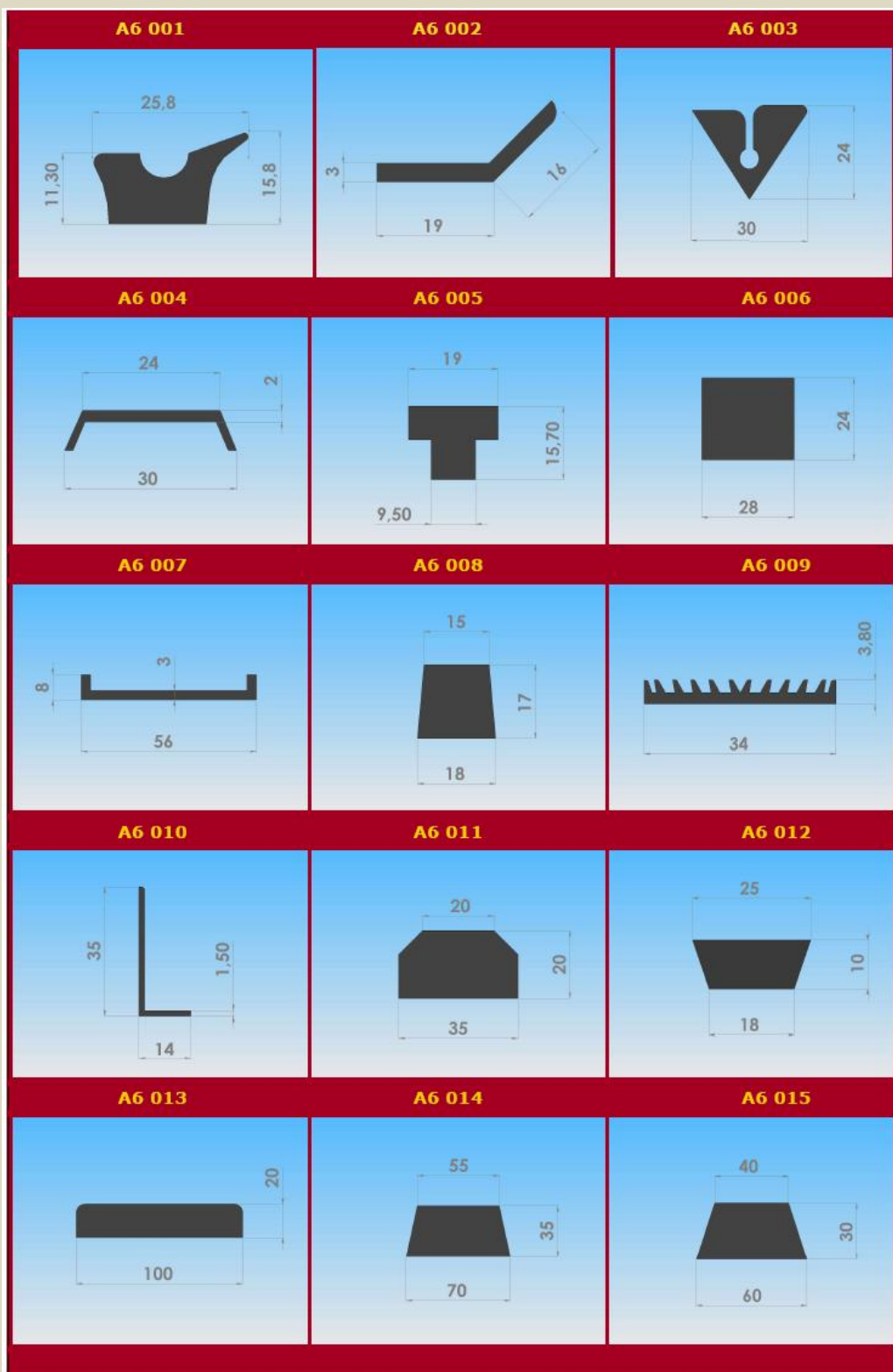

TEL: Bt - 00389 47 203 330 , Sk - 00389 02 3298130

FAKS: Bt - 00389 47 203 900 , Sk - 00389 02 3298130 E-mail : electrolux@t-home.mk

Veb-sajt: www.electrolux.mk

www.elektroluks.mk

Ulica:Bitola-Braka Mingovi Br.18, Skopje-Apostol Guslarot br. 1a



KATALOG ZA PROIZVODI OD GUMA

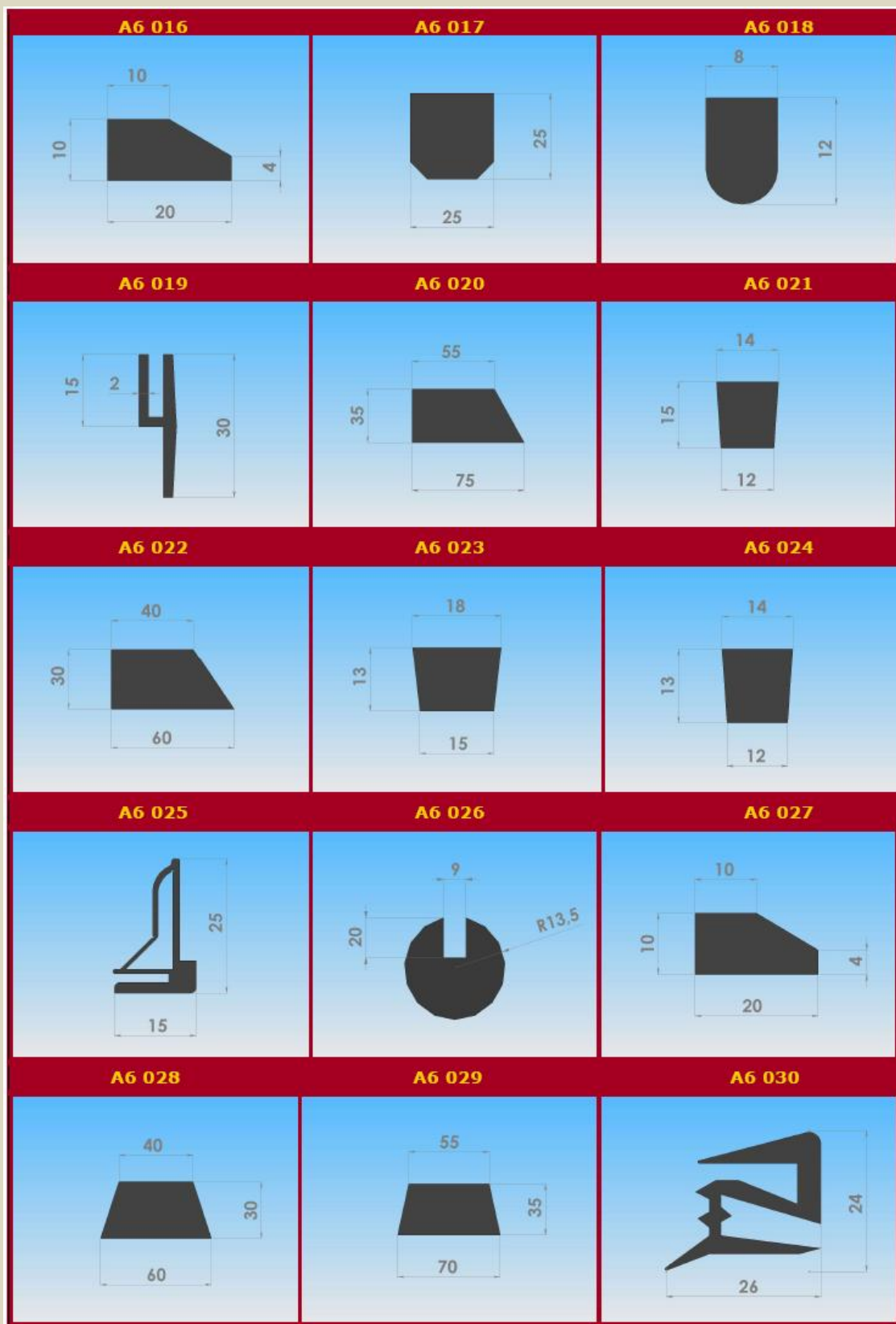

TEL: Bt - 00389 47 203 330 , Sk - 00389 02 3298130

FAKS: Bt - 00389 47 203 900 , Sk - 00389 02 3298130 E-mail : electrolux@t-home.mk

Veb-sajt: www.electrolux.mk

www.elektroluks.mk

Ulica:Bitola-Braka Mingovi Br.18, Skopje-Apostol Guslarot br. 1a



KATALOG ZA PROIZVODI OD GUMA



TEL: Bt - 00389 47 203 330 , Sk - 00389 02 3298130

FAKS: Bt - 00389 47 203 900 , Sk - 00389 02 3298130 E-mail : electrolux@t-home.mk

Veb-sajt: www.electrolux.mk

www.elektroluks.mk

Ulica:Bitola-Braka Mingovi Br.18, Skopje-Apostol Guslarot br. 1a



KATALOG ZA PROIZVODI OD GUMA

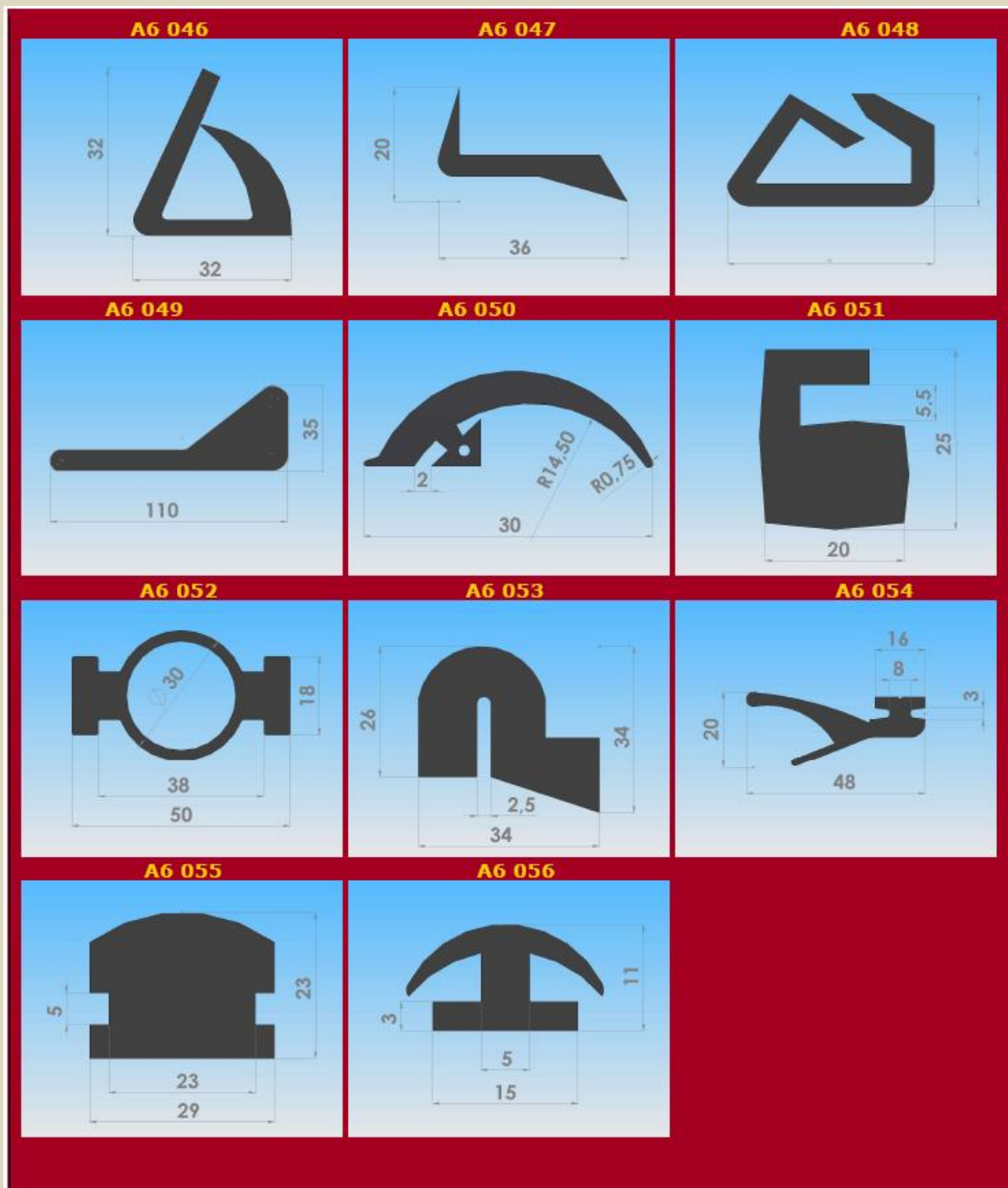

TEL: Bt - 00389 47 203 330 , Sk - 00389 02 3298130

FAKS: Bt - 00389 47 203 900 , Sk - 00389 02 3298130 E-mail : electrolux@t-home.mk

Veb-sajt: www.electrolux.mk

www.elektroluks.mk

Ulica:Bitola-Braka Mingovi Br.18, Skopje-Apostol Guslarot br. 1a



KATALOG ZA PROIZVODI OD GUMA



A7 agolni pecati za gradeznistvo

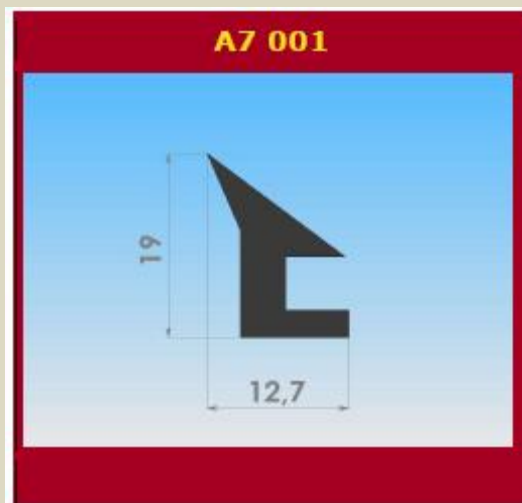

A8 Sungeresti Profili

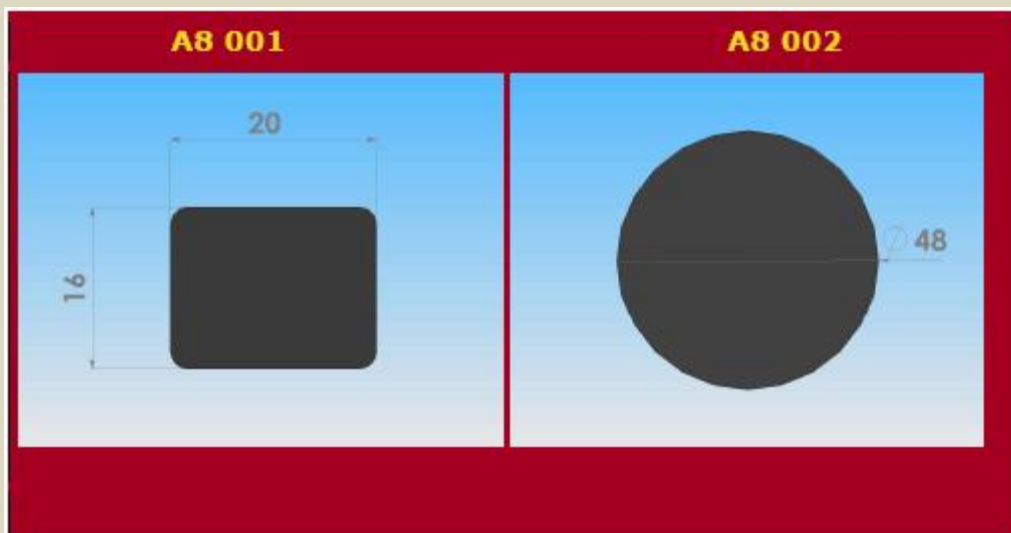

TEL: Bt - 00389 47 203 330 , Sk - 00389 02 3298130

FAKS: Bt - 00389 47 203 900 , Sk - 00389 02 3298130 E-mail : electrolux@t-home.mk

Veb-sajt: www.electrolux.mk

www.elektroluks.mk

Ulica:Bitola-Braka Mingovi Br.18, Skopje-Apostol Guslarot br. 1a



KATALOG ZA PROIZVODI OD GUMA



A9 Cevki za propan-butan plin



A10 Nearmirani Cevki (Cevki za protekovanje pijalok i sl.)



TEL: Bt - 00389 47 203 330 , Sk – 00389 02 3298130

FAKS: Bt - 00389 47 203 900 , Sk - 00389 02 3298130 E-mail : electrolux@t-home.mk

Veb-sajt: www.electrolux.mk

www.elektroluks.mk

Ulica:Bitola-Braka Mingovi Br.18, Skopje-Apostol Guslarot br. 1a



KATALOG ZA PROIZVODI OD GUMA



A11 Program za obnova na Tramvajski i Zeleznicki prugi

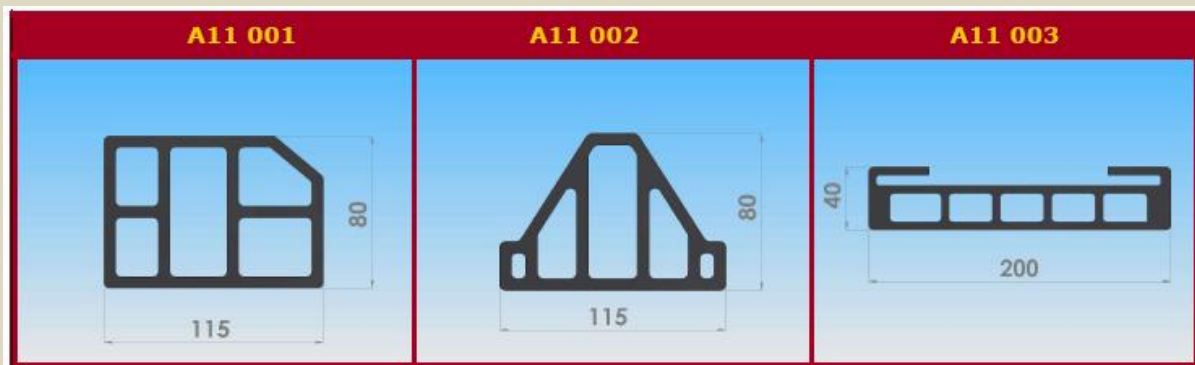

Osven gore navedenite profili vo moznost sme da proizvedeme profili od $\varnothing 3 - \varnothing 280$, odnosno 260 x 80 mm od sekakvi kvaliteti i oblici i prema svoja sema ili prema sema na kupovacot.

TEL: Bt - 00389 47 203 330 , Sk - 00389 02 3298130

FAKS: Bt - 00389 47 203 900 , Sk - 00389 02 3298130 E-mail : electrolux@t-home.mk

Veb-sajt: www.electrolux.mk

www.elektroluks.mk

Ulica:Bitola-Braka Mingovi Br.18, Skopje-Apostol Guslarot br. 1a



KATALOG ZA PROIZVODI OD GUMA



“B” Presovani Proizvodi

“B1” Odbojnici



TEL: Bt - 00389 47 203 330 , Sk – 00389 02 3298130

FAKS: Bt - 00389 47 203 900 , Sk - 00389 02 3298130 E-mail : electrolux@t-home.mk

Veb-sajt: www.electrolux.mk

www.elektroluks.mk

Ulica:Bitola-Braka Mingovi Br.18, Skopje-Apostol Guslarot br. 1a



B2 Pecati i Manžetni

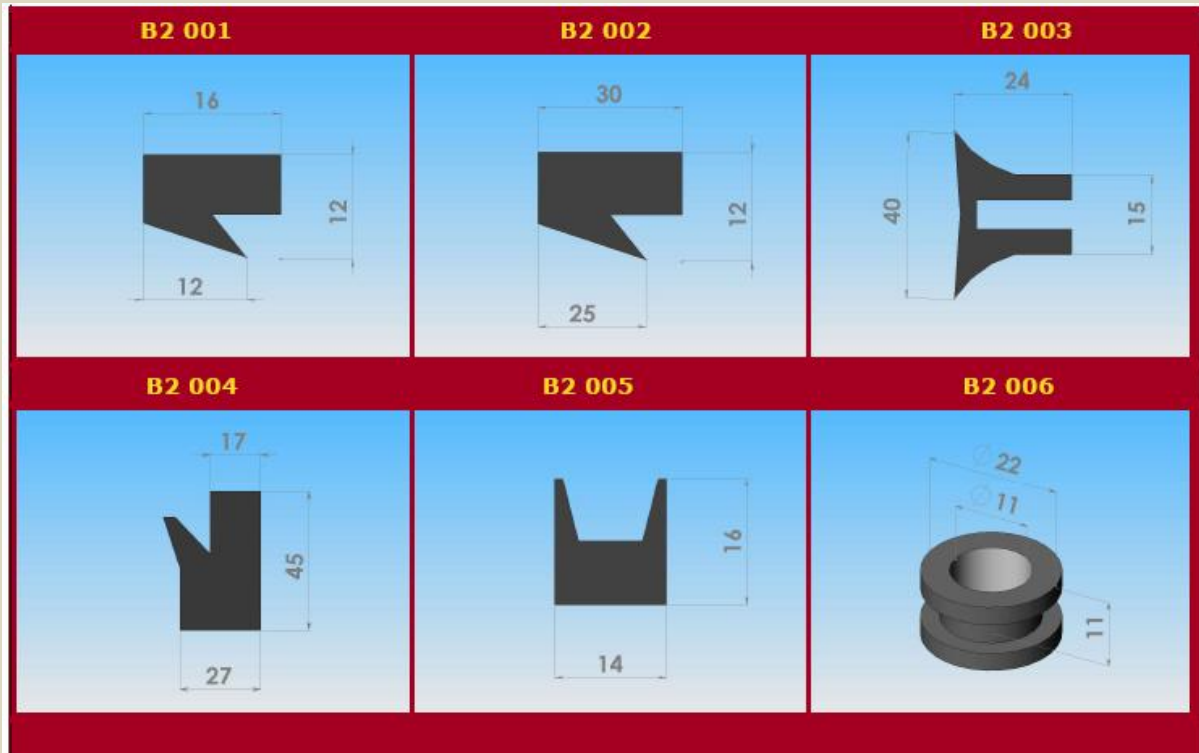

TEL: Bt - 00389 47 203 330 , Sk - 00389 02 3298130

FAKS: Bt - 00389 47 203 900 , Sk - 00389 02 3298130 E-mail : electrolux@t-home.mk

Veb-sajt: www.electrolux.mk

www.elektroluks.mk

Ulica:Bitola-Braka Mingovi Br.18, Skopje-Apostol Guslarot br. 1a

B3 Pecati, Svetilki, ormari, gumici na cilindrite

TEL: Bt - 00389 47 203 330 , Sk - 00389 02 3298130

FAKS: Bt - 00389 47 203 900 , Sk - 00389 02 3298130 E-mail : electrolux@t-home.mk

Veb-sajt: www.electrolux.mk

www.elektroluks.mk

Ulica: Bitola-Braka Mingovi Br.18, Skopje-Apostol Guslarot br. 1a



KATALOG ZA PROIZVODI OD GUMA



B4 Gumeni elementi na Spojkata



B5 Membrani

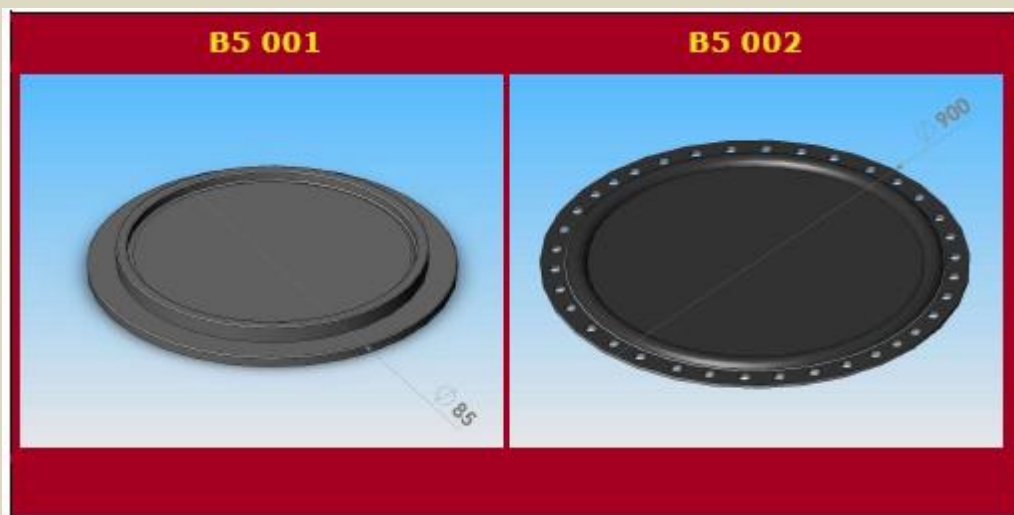

TEL: Bt - 00389 47 203 330 , Sk - 00389 02 3298130

FAKS: Bt - 00389 47 203 900 , Sk - 00389 02 3298130 E-mail : electrolux@t-home.mk

Veb-sajt: www.electrolux.mk

www.elektroluks.mk

Ulica:Bitola-Braka Mingovi Br.18, Skopje-Apostol Guslarot br. 1a



KATALOG ZA PROIZVODI OD GUMA



Branici od Prav , Armoniki



B7 Cevcesti i Valjacesti Proizvodi

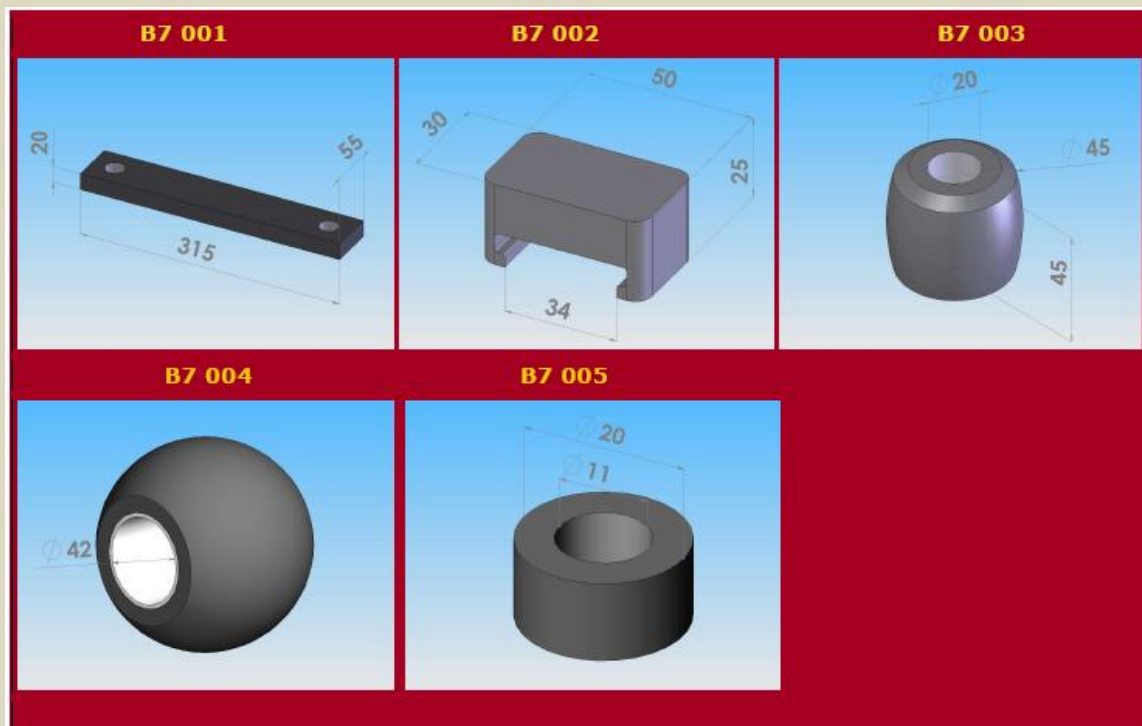

TEL: Bt - 00389 47 203 330 , Sk - 00389 02 3298130

FAKS: Bt - 00389 47 203 900 , Sk - 00389 02 3298130 E-mail : electrolux@t-home.mk

Veb-sajt: www.electrolux.mk

www.elektroluks.mk

Ulica:Bitola-Braka Mingovi Br.18, Skopje-Apostol Guslarot br. 1a



KATALOG ZA PROIZVODI OD GUMA



B8 Pecati od kruzen, kvadraten i tenok preseka

Kruzen presek

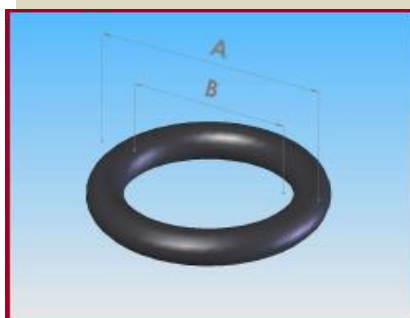

Kvadraten presek



Tenok presek

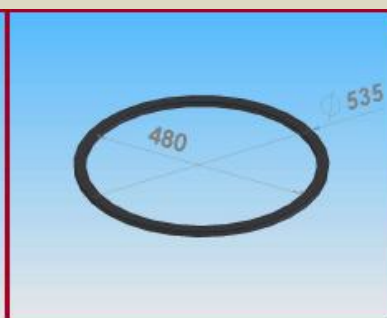

B9 Guma – Metalni Proizvodi

Amortizeri

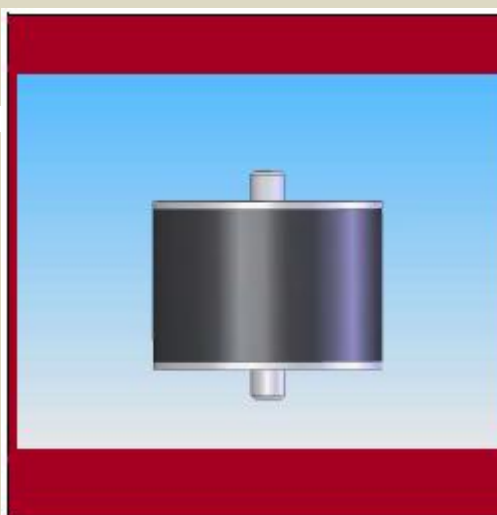

Izolator

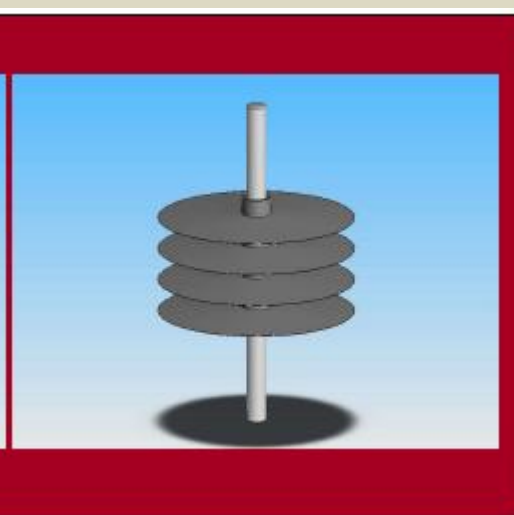

TEL: Bt - 00389 47 203 330 , Sk - 00389 02 3298130

FAKS: Bt - 00389 47 203 900 , Sk - 00389 02 3298130 E-mail : electrolux@t-home.mk

Veb-sajt: www.electrolux.mk

www.elektroluks.mk

Ulica: Bitola-Braka Mingovi Br.18, Skopje-Apostol Guslarot br. 1a



KATALOG ZA PROIZVODI OD GUMA



B10 – Podni Oblogi

Gumen Pod

Pod za stala

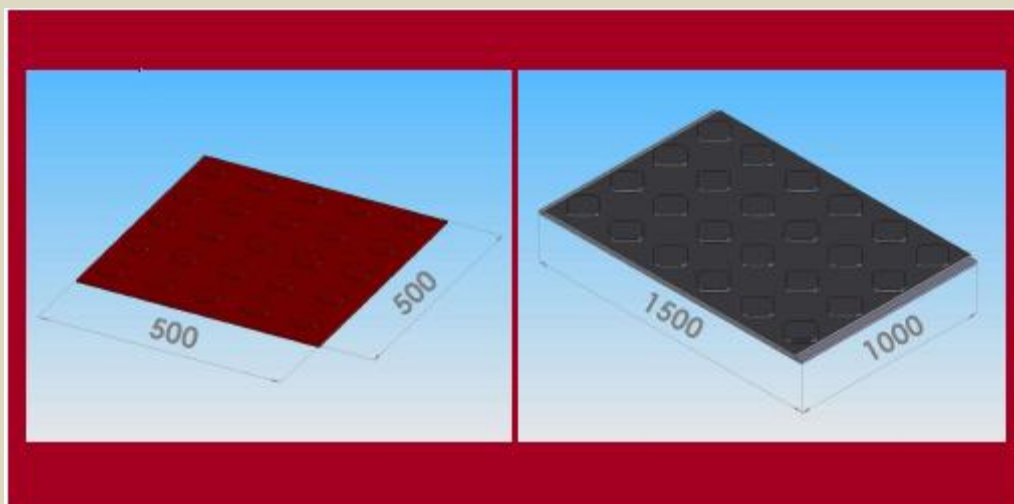

Sito za Kamenolomi

Sito za Kamenolomi

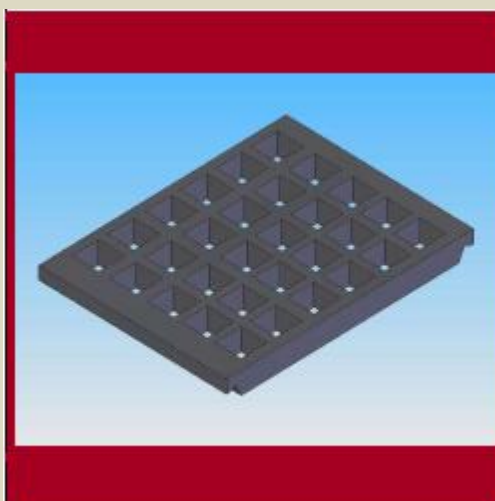

TEL: Bt - 00389 47 203 330 , Sk – 00389 02 3298130

FAKS: Bt - 00389 47 203 900 , Sk - 00389 02 3298130 E-mail : electrolux@t-home.mk

Veb-sajt: www.electrolux.mk

www.elektroluks.mk

Ulica:Bitola-Braka Mingovi Br.18, Skopje-Apostol Guslarot br. 1a



KATALOG ZA PROIZVODI OD GUMA



"C" Konfekcionizirani Proizvodi

C1 - Oblogi

Obloga za zeleznicko vozilo

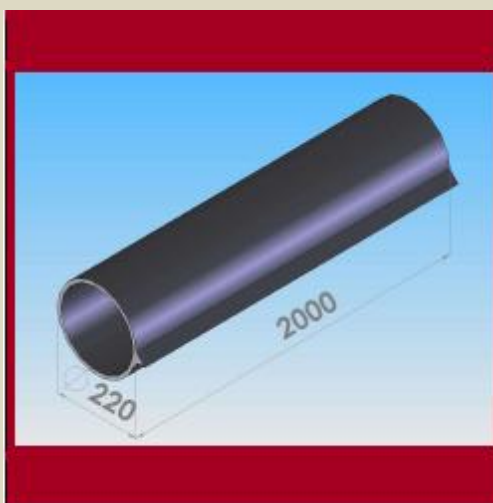

C2 – Armirani Cevki

Cevki za Razladni mesavini

Armirani cevki do 4 m dolzina



TEL: Bt - 00389 47 203 330 , Sk – 00389 02 3298130

FAKS: Bt - 00389 47 203 900 , Sk - 00389 02 3298130 E-mail : electrolux@t-home.mk

Veb-sajt: www.electrolux.mk

www.elektroluks.mk

Ulica:Bitola-Braka Mingovi Br.18, Skopje-Apostol Guslarot br. 1a



KATALOG ZA PROIZVODI OD GUMA



C3 – Gumiranje na Trkala i Valjaci

Gumiranje na Trkala

Gumiranje na Valjaci



C4 – Gumiranje na Ventili i Kutii

Materijalite koi se so gumirani kutii i ventili stiteni se od korozivni i abrazivni vlijanija na elementite sto se vo niv.

Izveduvame :

- Gumiranje na razlicni rezervoari za agresivni tecnosti (kiselini , alkalii)
- Gumiranje na kompletni cevovodi ili nivni delovi
- Gumiranje na ventili od kukista (membranski ventili)
- Gumiranje na bazeni
- Gumiranje na vibratorite za cistenje na metalnite delovi i sl.

TEL: Bt - 00389 47 203 330 , Sk – 00389 02 3298130

FAKS: Bt - 00389 47 203 900 , Sk - 00389 02 3298130 E-mail : electrolux@t-home.mk

Veb-sajt: www.electrolux.mk

www.elektroluks.mk

Ulica:Bitola-Braka Mingovi Br.18, Skopje-Apostol Guslarot br. 1a



KATALOG ZA PROIZVODI OD GUMA



“ D ” – Gumeni smesi

Materijal	Svojstva	Primena
NR-Priroden kauruk	<p>Cvrstina 35 – 100 °Sh A (shore) PREKIDNA CVRSTOCA: 6 – 20 Mpa (Megapaskali) PREKINUVAČKO ISTEGNUVANJE: 125 – 600 %</p> <ul style="list-style-type: none"> • Temperaturen interval od -50 °C do +80 °C • Mnogu dobri mehanicki osobini • Dobra elasticnost , dobar elektroizolator • Dobra otpornost na abenje <ul style="list-style-type: none"> - Prema tecnostite za kocnici na baza na gliokol ; - Prema razredenite kiselini i rastvori ; prema alkohol i voda 	Vodovodni cevk, amortizeri, transportni traki/avtoindustrija, gradeznistvo
NBR – AKRILONITRIL – BUTADIEN ELASTOMER	<p>Cvrstina : 35 – 100 °Sh A(SHORE) PREKINUVAČKA CVRSTINA: 6 – 20 Mpa (Megapaskali) Prekinuvacko istegnuvanje : 125 – 600 %</p> <ul style="list-style-type: none"> • Temperaturen interval od -30 °C do +100 °C • Dobri mehanicki osobini, visoka otpornost prema abenje • Mineralni masla od parafinen i naften tip ; masla i masti od rastitelno i zivotinsko poteklo ; • kiselini i rastvori so sredna koncentracija • Tesko zapalivi tecnosti ; dizel goriva 	

TEL: Bt - 00389 47 203 330 , Sk – 00389 02 3298130

FAKS: Bt - 00389 47 203 900 , Sk - 00389 02 3298130 E-mail : electrolux@t-home.mk

Veb-sajt: www.electrolux.mk

www.elektroluks.mk

Ulica:Bitola-Braka Mingovi Br.18, Skopje-Apostol Guslarot br. 1a



KATALOG ZA PROIZVODI OD GUMA



Materijal	Svojstva	Primena
CR – KLOROPREN ELASTOMER	CVRSTINA : 35 – 90 °Sh A PREKINUVACKA CVRSTINA : 6.5 – 19 Mpa PREKINUVACKO ISTEKNUVANJE : 190 – 600 % <ul style="list-style-type: none"> • Temperature interval od - 45 °C do +120 °C • dobra fleksibilnost na niski i visoki temperaturi • odlicna nepropustlivost na plinovite • sredna otpronost prema mineralni masla • dobra otpornost prema : <ul style="list-style-type: none"> • atmosferata i ozonot ; • recna i morska voda;alkoholot;glikolot; silikonskite masti i masla 	Izrabotka na razni pecati,semering, “O” Ring , cilindri,membrane,creva za motori vo brodovite,radijalen lezaj za pokrenuvanje na elipsata,propeleri,plinski cevki/izgradba na brodovi i drugi proizvodi koi imaat posebni baranja prema vlijanieto na atmosferata i ozonot.
SBR – STIREN – BUTADIEN ELASTOMER	CVRSTINA : 30 – 85 °Sh A PREKINUVACKA CVRSTINA : 6 – 14 Mpa PREKINUVACKO ISTEKNUVANJE : 200 – 300 % <ul style="list-style-type: none"> • temperaturen interval od - 50 °C do +100 °C • dobri mehanicki svojstva na niskite i visokite temperature • dobra otpornost : na abenje prema tecnostite na baza na glikol ; neorganski i organski kiselini i mesavini;alkohol 	Hidraulika,sistemi za kocenje,tramvai,vagoni,avto i teretni vozila/golema primena imaat i vo avtomobilskata industrija

TEL: Bt - 00389 47 203 330 , Sk – 00389 02 3298130

FAKS: Bt - 00389 47 203 900 , Sk - 00389 02 3298130 E-mail : electrolux@t-home.mk

Veb-sajt: www.electrolux.mk

www.elektroluks.mk

Ulica:Bitola-Braka Mingovi Br.18, Skopje-Apostol Guslarot br. 1a



KATALOG ZA PROIZVODI OD GUMA



Materijal	Svojstva	Primena
EPDM – ETILEN – PROPILEN DIEN MONOMER ELASTOMER	CVRSTINA : 40 – 85 °Sha PREKINUVACKA CVRSTINA : 5 – 10 Mpa PREKINUVACKO ISTEGNUVANJE: 150 – 400 % <ul style="list-style-type: none"> • temperaturen interval od - 50 °C do +130 °C • dobri mehanicki svojstva na niski i visoki temperaturi • izvonredna otpornost: na stareenje,vlijanieto na atmosferata i ozonot,na elektricnata probojnost • dobra otpornost : na abenje od tecnostite na baza na gliokol : neorganski i organski kiselini i mesavini ; mesavini 	Membrani , pecati , cilindri i cevki na masinite za perenje i susenje na alista i cinii , pecati na radiatora ,kabli,cevkite na sisteme za ladanje kaj avtomobile
FKM – FLUOR ELASTOMER / VITOR	CVRSTINA : 60 – 95 °Sh A PREKINUVACKA CVRSTINA: 9 – 15 Mpa PREKINUVACKO ISTEGNUVANJE : 100 – 200 % <ul style="list-style-type: none"> • temperaturen interval od - 25 °C do +200 °C • dobra otpornost prema: mineralni masla i masti ; auromaticki masla;goriva,tesko zapaljiv hidraulicki tecnosti ; sinteticki masla ; kiselini i mesavini; jaki oksidacioni sredstva 	Masleno-osovinski pecati, “O” Ring , pecati na ladicnicite i peckite , i drugi masini kaj ko sto osnovno baranje e zapecatuvanje na niski i visoki temperaturi / avtomobilski industrii,zelezari,metalurgija, Brodogradnistvo, avio-industrija

TEL: Bt - 00389 47 203 330 , Sk – 00389 02 3298130

FAKS: Bt - 00389 47 203 900 , Sk - 00389 02 3298130 E-mail : electrolux@t-home.mk

Veb-sajt: www.electrolux.mk

www.elektroluks.mk

Ulica:Bitola-Braka Mingovi Br.18, Skopje-Apostol Guslarot br. 1a



KATALOG ZA PROIZVODI OD GUMA



Materijal	Svojstva	Primena
SILIKON ELASTOMER	CVRSTINA: 50 – 85 °Sha PREKINUVACKA CVRSTINA : 3,5 Mpa PREKINUVACKO ISTEGRUVANJE: 200 – 300 % <ul style="list-style-type: none"> • temperaturen interval od - 25 °C do +200 °C • ima dobri mehanicki i dielektricni osobini • dobra otpornost prema: atmosferata i ozonot • sredna otpornost prema : mineralni masla i masti ednovalentnite i povekevalentnite alkoholi; vodeni sloevi na soli 	“O” Soli , masleno-osovinskite pecati,provodnici,elektricni izolacioni delovi/Naftena industrija,avtomobilaska industrija,energetika (izolacija) , prehrambrena industrija

Zaradi ponatamosniot razvoj na proizvodite,go zadrzuvame pravoto na smenuvanje na navedenite podatoci i karakteristiki.Ovoj katalog e od orientaciska priroda,zatoa obratete ni se nas so vasite baranja i informacii so polna doverba.

TEL: Bt - 00389 47 203 330 , Sk – 00389 02 3298130

FAKS: Bt - 00389 47 203 900 , Sk - 00389 02 3298130 E-mail : electrolux@t-home.mk

Veb-sajt: www.electrolux.mk

www.elektroluks.mk

Ulica:Bitola-Braka Mingovi Br.18, Skopje-Apostol Guslarot br. 1a