



Spare parts suitable for: **BLUMAUER**

DB
Suitable for Blumauer

Spare parts suitable for modular ranges



Spare parts suitable for single devices



G.E.V. Großküchen-Ersatzteil-Vertrieb GmbH
Robert-Koch-Straße 3a
82152 Planegg/Munich
Germany

Phone: +49 (0)89 745572-0
Fax: +49 (0)89 745572-83
order@gev-online.com
www.gev-online.com

Member of the  **GEV GROUP**

Open tops (gas)



Item	Order	Description	Model	OEM
1	103080	burner cover C, 80mm	G20, G40,	183725
2	103082	burner cover D	G60, G80,	183723
3	103081	burner cover E, 100mm	GG21	183727

Open tops (electric)

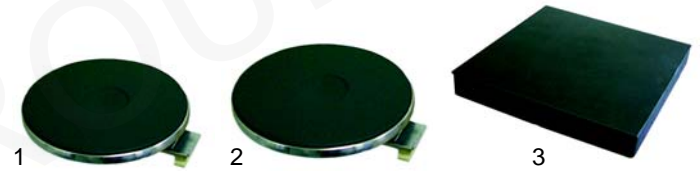

Item	Order	Description	Model	OEM
1	490017	2000W, 400V, 180mm	E22_, E42_	180110
2	490021	2600W, 400V, 220mm	E62_	180120
3	490078	3000W, 400V, 300x300mm	universal	180131

Suitable for Blumauer



Item	Order	Description	Model	OEM
1	100059	pilot burner		183305
2	100703	electrode	G20, G40,	
3	102219	thermocouple, 450mm	G60, G80,	183113
3	102221	thermocouple, 750mm	GG21	183114



Item	Order	Description	Model	OEM
1	300023	4-position switch	universal	180510
2	300025	7-position switch	E22, E42, E62	180511
3	110191	knob	universal	190211

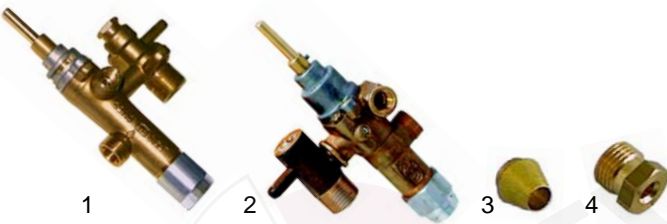

Item	Order	Description	Model	OEM
1	n. l. a.	gas tap EGA		
2	101606	gas tap PEL	G20, G40,	183050, 183051,
3	101246	olive, 4mm	G60, G80,	183052, 183053,
4	100908	union screw, M10x1, 4mm	GG21	183054, 183055

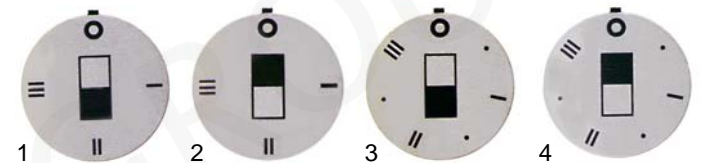

Item	Order	Description	Model	OEM
1	110507	symbol, 4-tacts (in the front)	universal	190220
2	110508	symbol, 4-tacts (at the back)		190221
3	110509	symbol, 7-Takt (in the front)	E22, E42, E62	190222
4	110510	symbol, 7-Takt (at the back)		190223

Solid tops (gas)

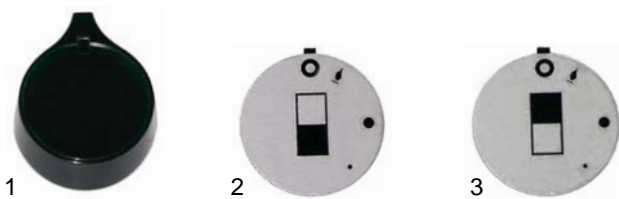

Item	Order	Description	Model	OEM
1	110191	knob	G20, G40,	190210
2	110501	symbol/in the front	G60, G80,	190237
3	110502	symbol/at the back	GG21	190236



Item	Order	Description	Model	OEM
1	no longer available	gas tap EGA		183012
2	101620	gas tap PEL	GG01, GG02, GG21	183012
3	110191	knob		190210
4	110504	symbol		190231

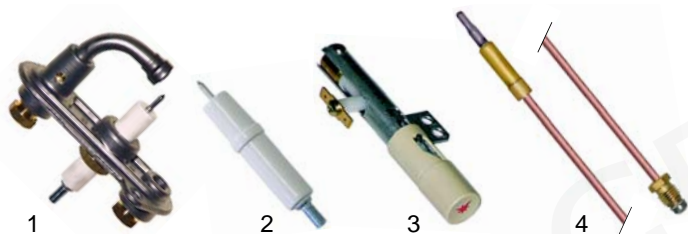

Item	Order	Description	Model	OEM
1	100059	pilot burner		183305
2	100703	electrode	GG01,	-
3	100007	piezoelectric igniter	GG02,	183306
4	102219	thermocouple, 450mm	GG21	183113

Ovens (gas)



Item	Order	Description	Model	OEM
1	105878	burner	G_B,	64049130,
			GG_B	48091030
2	100059	pilot burner		183305
3	102223	thermocouple		183102

Ovens (electric)

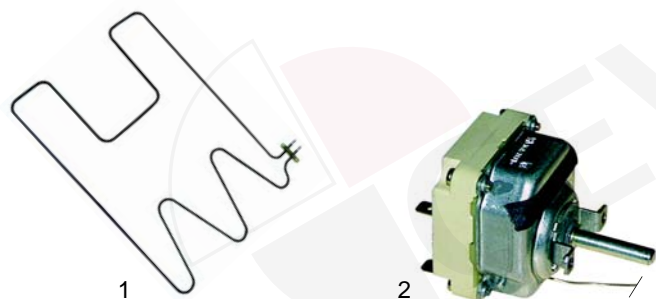

Item	Order	Description	Model	OEM
1	415585	2000W/400V	E_B,	180352
2	375038	thermostat, 300°C	G_EB	183305



Item	Order	Description	Model	OEM
1	110191	knob		190210
2	110520	symbol	E_B,	190234
3	359169	signal lamp, 400V	G_EB	-
4	359198	signal lamp, 400V		-

Bains-marie (electric)



Item	Order	Description	Model	OEM
1	375143	thermostat, 110°C	E_WS,	180705
2	110191	knob	E_B/WS,	190210
3	110517	symbol	G_EWS,	
			EWAS_	

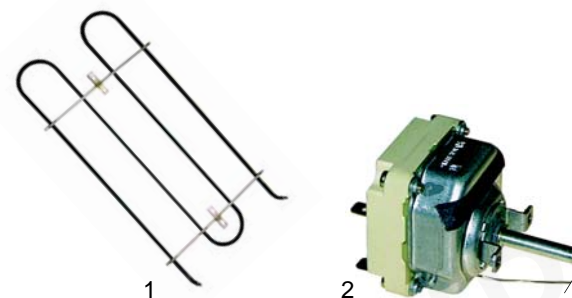

Item	Order	Description	Model	OEM
1	415583	1100W/400V		180355
2	375143	thermostat	EWAS_BI	180705

Tilting bratt pans (electric)

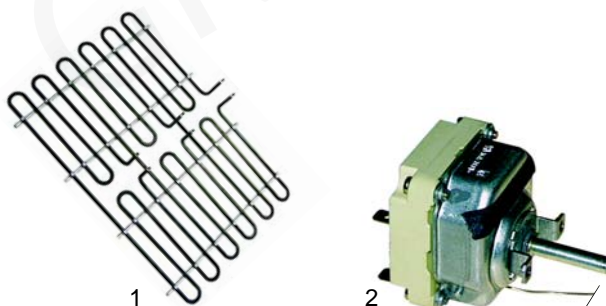

Item	Order	Description	Model	OEM
1	415584	5000W/400V	EKB_	180373
2	375038	thermostat		180706

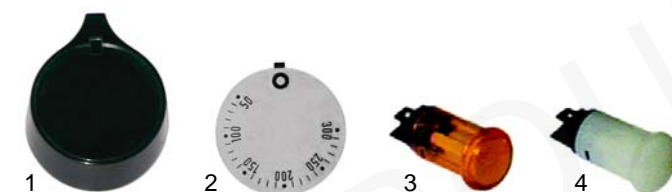

Item	Order	Description	Model	OEM
1	110191	knob		190210
2	110520	symbol		190234
3	359169	signal lamp, 400V	EKB_	-
4	359198	signal lamp, 400V		-

Boiling pans (electric)



Item	Order	Description	Model	OEM
1	415581	3000W/230V	ESK	180361
2	415582	5000W/230V	EWBK	180362
3	418265	500W/230V	ESK, EBWK	180711



Item	Order	Description	Model	OEM
1	540136	drain tap, 1 1/4"		185001
1	540137	drain tap, 1 1/2"		185000
2	540079	filling funnel	ESK, EBWK	185060
3	541407	pressure relief valve		185053
4	514353	safety valve		185021

B

Suitable for Blumauer

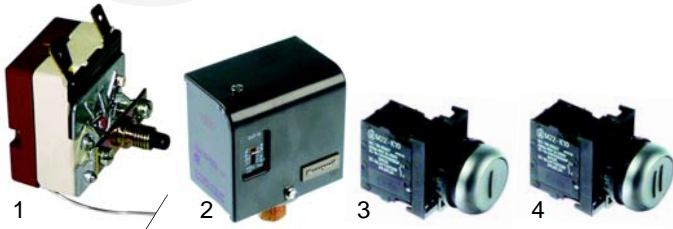

Item	Order	Description	Model	OEM
1	375157	safety thermostat		180710
2	541377	pressure switch	ESK, EBWK	185070
3	346438	switch I (complete)		180655
4	346439	switch II (complete)		180656

Single devices

Stockpot stoves (gas)

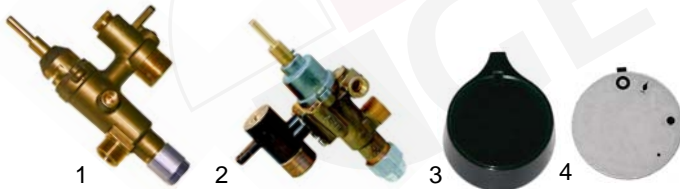

Item	Order	Description	Model	OEM
1	n. l. a.	gas tap EGA		183011
2	101622	gas tap PEL	GHK	183011
3	110191	knob		190210
4	110504	symbol		190231

Stockpot stoves (electrical)



Pos.	Order	Description	Model	OEM
1	490106	5000W/400V, 400mm	EHK	180411



Item	Order	Description	Model	OEM
1	100059	pilot burner		183305
2	100703	electrode	GHK	-
3	102219	thermocouple, 450mm		183113



Item	Order	Description	Model	OEM
1	300023	4-position switch		180510
2	110191	knob	EHK	190210
3	110507	symbol		190220

P020106201

