

50 Hz



TLC, TLCH, FLC, EFLC Series

WET ROTOR CIRCULATORS FOR
HEATING, COOLING AND SANITARY SYSTEMS

EXPORT (EXTRA-EEA COUNTRIES)

Cod. 191007570 Rev.A Ed.03/2013

 **LOWARA**
a xylem brand

CONTENTS

Product Range Chart	4
TLC Series	7
TLCH Series	13
FLC Series	17
EFLC Series	45
Installation Positions	56
Technical Appendix	59

TLC, TLCH SERIES PRODUCT RANGE CHART

TYPE	Version		Power supply		Pump coupling		Temperature of pumped liquid			Ambient temperature	Protection class
	Single	Twin	Single-phase 230 V 50 Hz	Three-phase 400 V 50 Hz	Threaded	Flanged	+2°C ÷ +110°C	-15°C ÷ +100°C	-15°C ÷ +110°C	Max 40°C	IP 44
RESIDENTIAL											
TLC 15-2.5	•		•		•		•			•	•
TLC 25-2.5L	•		•		•		•			•	•
TLC 32-2.5L	•		•		•		•			•	•
TLC 15-4	•		•		•		•			•	•
TLC 25-4	•		•		•		•			•	•
TLC 25-4L	•		•		•		•			•	•
TLC 32-4L	•		•		•		•			•	•
TLC 15-5	•		•		•		•			•	•
TLC 25-5	•		•		•		•			•	•
TLC 25-5L	•		•		•		•			•	•
TLC 32-5L	•		•		•		•			•	•
TLC 15-6	•		•		•		•			•	•
TLC 25-6	•		•		•		•			•	•
TLC 25-6L	•		•		•		•			•	•
TLC 32-6L	•		•		•		•			•	•
TLC 15-7	•		•		•		•			•	•
TLC 25-7L	•		•		•		•			•	•
TLC 32-7L	•		•		•		•			•	•
LIGHT COMMERCIAL											
TLCH 25-7L	•		•		•		•			•	•
TLCH 32-7L	•		•		•		•			•	•
TLCH 25-8L	•		•		•		•			•	•
TLCH 32-8L	•		•		•		•			•	•
TLCH 25-10L	•		•		•		•			•	•
TLCH 32-10L	•		•		•		•			•	•
TLCH 25-12L	•		•		•		•			•	•
TLCH 32-12L	•		•		•		•			•	•

tlc-tlch-modelli-en_a_sc

FLC(G), EFLC(G) SERIES PRODUCT RANGE CHART

TYPE	Version		Power supply		Pump coupling		Temperature of pumped liquid			Ambient temperature		Protection class
	Single	Twin	Single-phase 230 V 50 Hz	Three-phase 400 V 50 Hz	Threaded	Flanged	+2°C ÷ +110°C	-15°C ÷ +100°C	-15°C ÷ +110°C	Max 40°C		IP 44
COMMERCIAL												

FLC (G) 40-5	•	•	•			•			•	•	•
FLC (G) 40-7	•	•	•			•			•	•	•
FLC (G) 40-10	•	•	•			•		•	•	•	•
FLC (G) 50-5	•	•	•			•		•	•	•	•
FLC (G) 50-8	•	•	•			•		•	•	•	•
FLC (G) 50-10	•	•	•			•		•	•	•	•
FLC 50-13	•		•			•		•	•	•	•
FLC (G) 65-7	•	•	•			•		•	•	•	•
FLC (G) 65-10	•	•	•			•		•	•	•	•
FLC (G) 65-12	•	•	•			•		•	•	•	•
FLCG 80-4		•	•			•		•	•	•	•
FLC (G) 80-8	•	•	•			•		•	•	•	•
FLC (G) 80-10	•	•	•			•		•	•	•	•

FLC (G) 40-5 T	•	•		•		•			•	•	•
FLC (G) 40-7 T	•	•		•		•			•	•	•
FLC (G) 40-10 T	•	•		•		•			•	•	•
FLC (G) 50-5 T	•	•		•		•			•	•	•
FLC (G) 50-8 T	•	•		•		•			•	•	•
FLC (G) 50-10 T	•	•		•		•			•	•	•
FLC 50-13 T	•			•		•			•	•	•
FLC 50-18 T	•			•		•			•	•	•
FLC (G) 65-7 T	•	•		•		•			•	•	•
FLC (G) 65-10 T	•	•		•		•			•	•	•
FLC (G) 65-12 T	•	•		•		•			•	•	•
FLC (G) 65-16 T	•	•		•		•			•	•	•
FLCG 80-4 T		•		•		•			•	•	•
FLC (G) 80-8 T	•	•		•		•			•	•	•
FLC (G) 80-10 T	•	•		•		•			•	•	•
FLC (G) 80-12 T	•	•		•		•			•	•	•
FLC (G) 80-15 T	•	•		•		•			•	•	•

TYPE	Version		Power supply		Pump coupling		Temperature of pumped liquid			Ambient temperature		Protection class
	Single	Twin	Single-phase 230 V 50 Hz	Three-phase 400 V 50 Hz	Threaded	Flanged	+15°C ÷ +70°C	+15°C ÷ +90°C	+15°C ÷ +110°C	Max 30°C	Max 40°C	IP 42
COMMERCIAL												

EFLC (G) 40-9	•	•	•			•			•	•	•
EFLC (G) 40-11	•	•	•			•			•	•	•
EFLC (G) 50-12	•	•	•			•		•	•	•	•
EFLC (G) 65-12	•	•	•			•		•	•	•	•
EFLC (G) 80-7	•	•	•			•		•	•	•	•

EFLC (G) 40-9	•	•	•			•			•	•	•
EFLC (G) 40-11	•	•	•			•			•	•	•
EFLC (G) 50-12	•	•	•			•		•	•	•	•
EFLC (G) 65-12	•	•	•			•		•	•	•	•
EFLC (G) 80-7	•	•	•			•		•	•	•	•

Circulators for residential systems

TLC Series



MARKET SECTORS

RESIDENTIAL.

APPLICATIONS

- Water circulation in heating and air conditioning systems.
- Pumping of hot/cold liquids, chemically or mechanically non-aggressive, non-explosive, without solids or fiber matter.

SPECIFICATIONS

PUMP

- **Flow rate:** up to 4 m³/h.
- **Head:** up to 7 m.
- **Temperature of pumped liquid:** +2°C ÷ +110°C.
Avoid condensation and ice formation.
Maximum 20% glycol and water mixture.
For glycol quantities higher than 20%, hydraulic performances must be checked.
- **Maximum operating pressure:** 10 bar (PN 10).
- **Impeller:** made of composite material.
- **Wear ring:** ceramic.

MOTOR

- Wet rotor type, with bearings lubricated by the pumped liquid.
Axial and radial bearings made of ceramic.
- Single-phase 230 V 50 Hz power supply. Terminal box axially integrated in the motor.
- 2-pole, three-speed motor, with manual speed selection.
- **Insulation class** 180 (H).
- **Protection class** IP 44.

CONSTRUCTION CHARACTERISTICS

- Electric circulator pumps with in-line suction and discharge ports, designed for direct installation onto piping, with 1", 1" ½ and 2" threaded connections.
- According to IEC 60335-1 and 60335-2-51 standards.

ACCESSORIES

- Pipe unions.
- Insulation shell.

INSTALLATION

- Suitable for installation in horizontal or vertical piping, in any position provided that motor axis is horizontal.

TLC SERIES IDENTIFICATION CODE

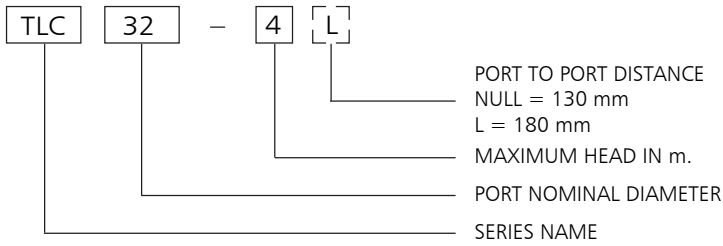

EXAMPLE : TCL 32-4L

TCL series circulator, port nominal diameter = 32, max head = 4 m, with port to port distance of 180 mm.

TABLE OF MATERIALS

PART	MATERIAL
Pump body	Cast iron cataphoretically coated
Impeller	Composite material
Shaft	Ceramics
Inner jacket	Stainless steel
Wear ring	Ceramics
Bearings	Ceramics
Gaskets	EPDM

tlc-2p50-en_a_tm

TLC SERIES HYDRAULIC PERFORMANCE TABLE

PUMP TYPE	MAXIMUM ABSORBED POWER W	MAXIMUM ABSORBED CURRENT A	CAPACITOR		SPEED	Q = DELIVERY								
						l/s 0	0,2	0,3	0,5	0,6	0,7	0,8	0,9	1,1
						m ³ /h 0	0,6	1,2	1,7	2,0	2,4	2,8	3,2	3,9
230V 50Hz			μF	V		H = TOTAL HEAD METRES COLUMN OF WATER								
TLC 15-2.5	27	0,12	1,5	400	1	2,1	2,0	1,5	1,1	0,8				
TLC 25-2.5L	32	0,14			2	2,3	2,1	1,7	1,3	1,1				
TLC 32-2.5L	35	0,15			3	2,5	2,3	1,9	1,5	1,2	0,9			
TLC 15-4	33	0,14	1,5	400	1	3,5	2,7	1,8	1,2	0,8				
TLC 25-4 (L)	39	0,17			2	3,9	3,2	2,4	1,9	1,6	1,1			
TLC 32-4L	44	0,19			3	4,2	3,5	2,8	2,2	1,9	1,5	0,9		
TLC 15-5	43	0,19	2,0	400	1	3,9	2,9	2,0	1,3	0,8				
TLC 25-5 (L)	63	0,28			2	4,8	4,3	3,7	3,0	2,5	1,8	0,9		
TLC 32-5L	77	0,34			3	5,2	4,9	4,4	3,8	3,5	3,0	2,3	1,8	
TLC 15-6	43	0,19	2,0	400	1	3,4	2,3	1,5	0,9					
TLC 25-6 (L)	65	0,28			2	5,2	4,1	3,0	2,1	1,7	1,1			
TLC 32-6L	80	0,34			3	6,2	5,6	4,7	4,0	3,6	3,0	2,4	1,8	
TLC 15-7	54	0,24	2,0	400	1	5,4	3,6	2,5	1,7	1,4	0,9	0,4		
TLC 25-7L	76	0,34			2	6,6	5,5	4,0	2,9	2,3	1,6	1,0	0,4	
TLC 32-7L	89	0,39			3	7,1	6,6	5,9	5,2	4,7	3,9	2,9	2,0	0,4

Performances according to standard EN 1151-1

tlc-2p50-en_b_th

**TLC SERIES
SINGLE-PHASE OPERATING CHARACTERISTICS**

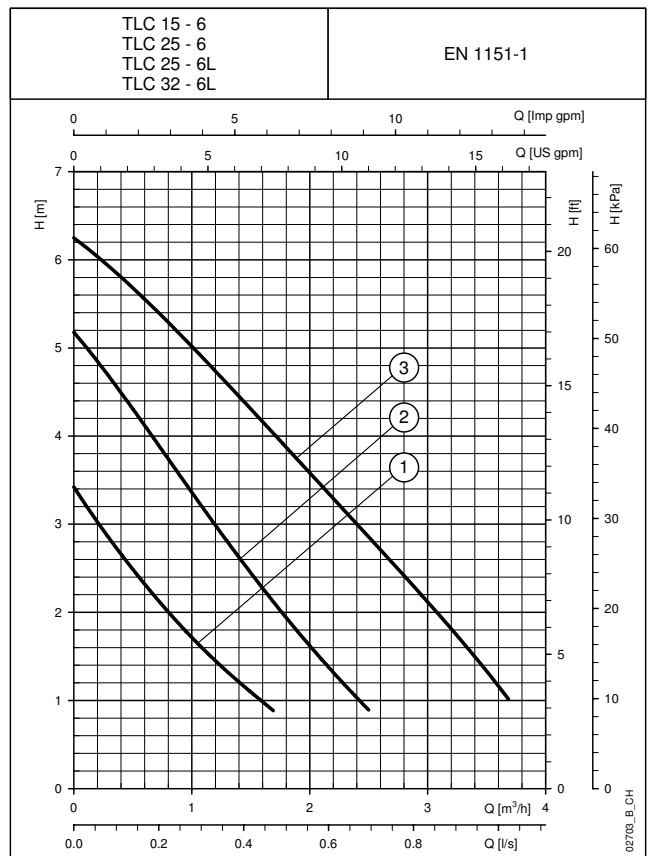
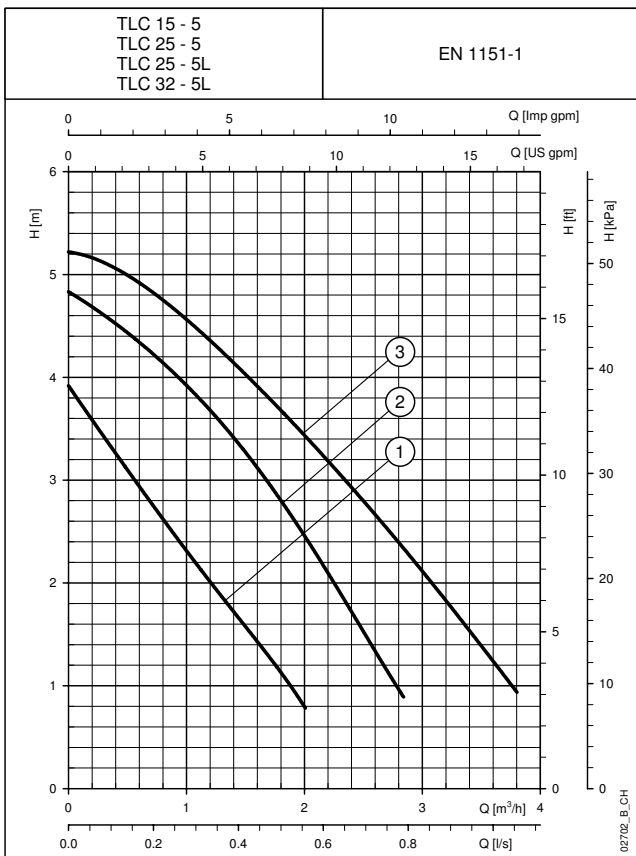
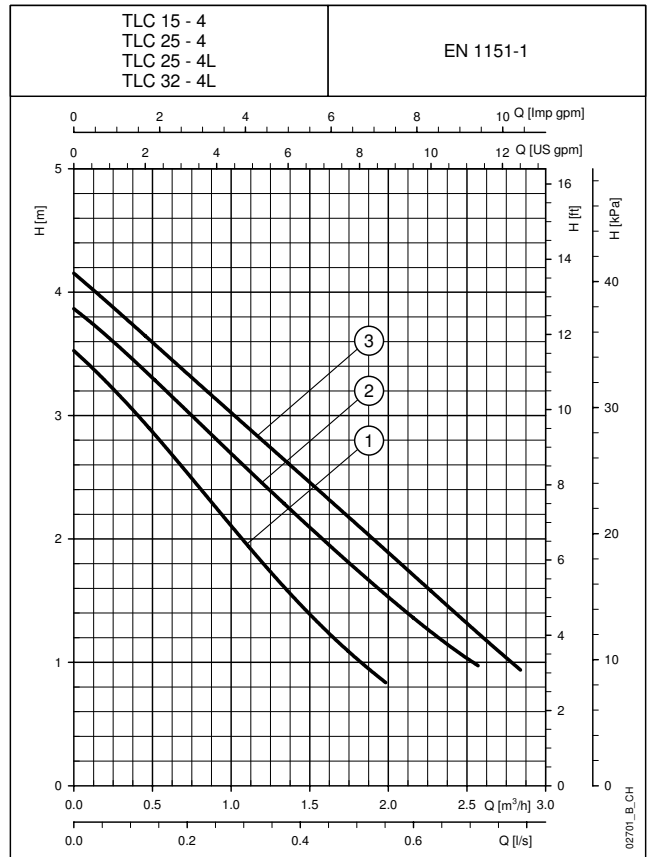
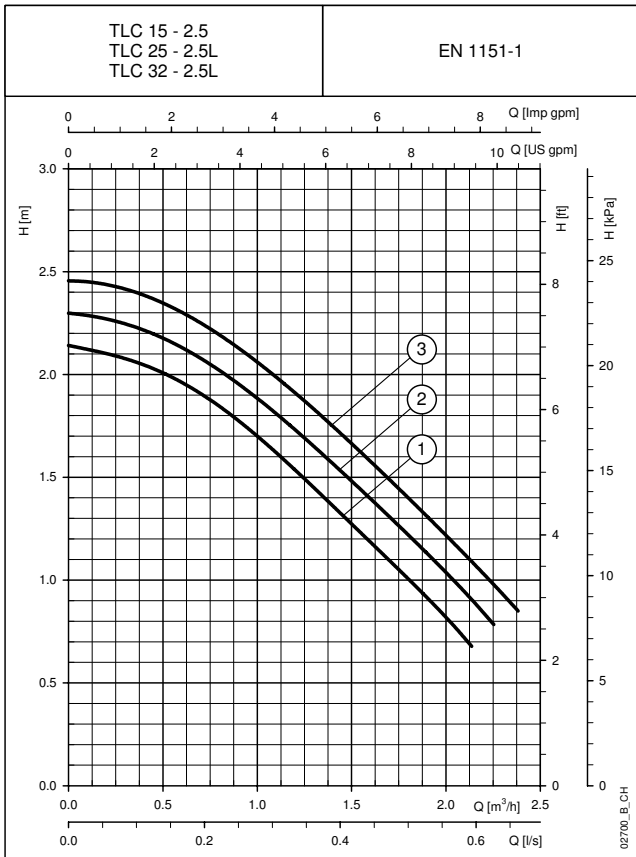

These performances are valid for liquids with density $\rho = 1.0 \text{ Kg/dm}^3$ and kinematic viscosity $\nu = 1 \text{ mm}^2/\text{sec}$.

**TLC SERIES
SINGLE-PHASE OPERATING CHARACTERISTICS**

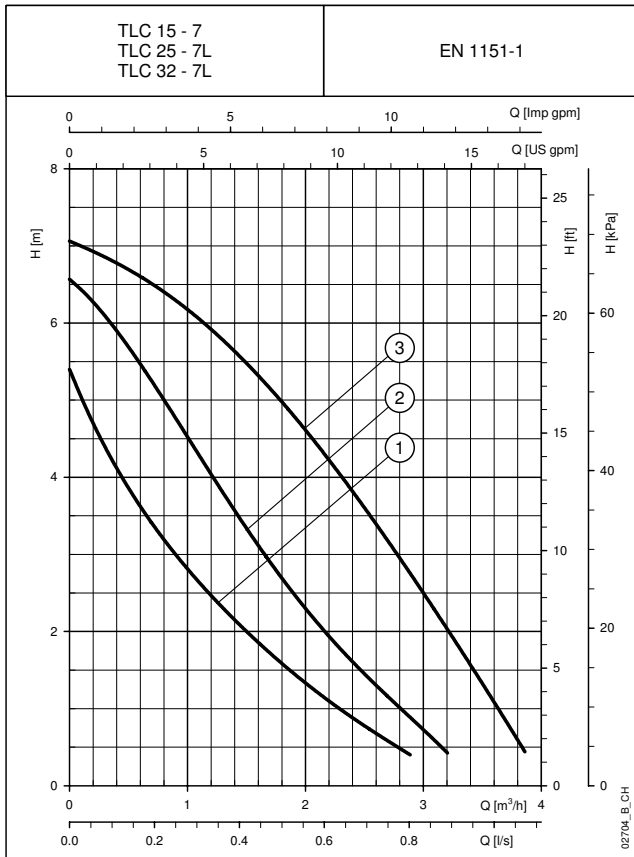

These performances are valid for liquids with density $\rho = 1.0 \text{ Kg/dm}^3$ and kinematic viscosity $\nu = 1 \text{ mm}^2/\text{sec}$.

TLC SERIES DIMENSIONS AND WEIGHTS

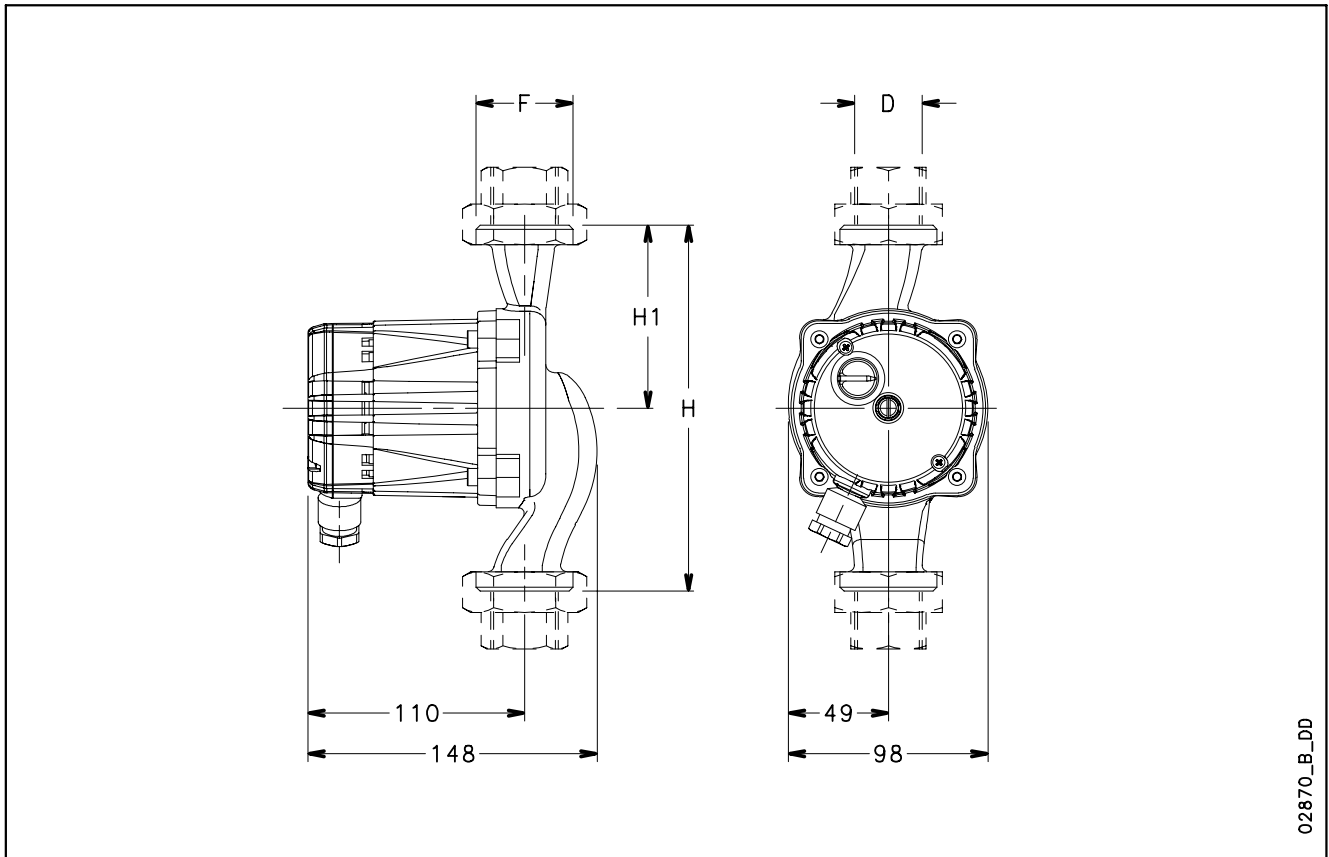

02870_B_DD

DIMENSIONS AND WEIGHTS TABLE

PUMP TYPE	DIMENSIONS (mm)					WEIGHT kg
	H	H1	D	F	DN	
TLC 15-2.5	130	65	1/2"	G 1"	15	2,6
TLC 25-2.5L	180	90	1"	G 1 1/2"	25	2,7
TLC 32-2.5L	180	90	1 1/4"	G 2"	32	2,8
TLC 15-4	130	65	1/2"	G 1"	15	2,6
TLC 25-4	130	65	1"	G 1 1/2"	25	2,7
TLC 25-4L	180	90	1"	G 1 1/2"	25	2,7
TLC 32-4L	180	90	1 1/4"	G 2"	32	2,8
TLC 15-5	130	65	1/2"	G1"	15	2,6
TLC 25-5	130	65	1"	G 1 1/2"	25	2,7
TLC 25-5L	180	90	1"	G 1 1/2"	25	2,7
TLC 32-5L	180	90	1 1/4"	G 2"	32	2,8
TLC 15-6	130	65	1/2"	G 1"	15	2,6
TLC 25-6	130	65	1"	G 1 1/2"	25	2,7
TLC 25-6L	180	90	1"	G 1 1/2"	25	2,8
TLC 32-6L	180	90	1 1/4"	G 2"	32	2,8
TLC 15-7	130	65	1/2"	G 1"	15	2,6
TLC 25-7L	180	90	1"	G 1 1/2"	25	2,8
TLC 32-7L	180	90	1 1/4"	G 2"	32	2,8

tlc-2p50-en_c_td

Circulators for residential systems

TLCH Series



MARKET SECTORS

LIGHT COMMERCIAL.

APPLICATIONS

- Circulation of water in heating and air conditioning high flow/high head systems.
- Pumping of hot/cold liquids, chemically or mechanically non-aggressive, non-explosive, without solids or fiber matter.

SPECIFICATIONS

PUMP

- **Flow rate:** up to 12 m³/h.
- **Head:** up to 12 m.
- **Temperature of pumped liquid:** +2°C ÷ +110°C.
Avoid condensation and ice formation.
Maximum of 20% glycol and water mixture.
For glycol quantities higher than 20%, hydraulic performances must be checked.
- **Maximum operating pressure:** 10 bar (PN 10).
- **Impeller:** made of composite material.
- **Wear ring:** ceramic.

MOTOR

- Wet rotor type, with bearings lubricated by the pumped liquid.
Axial and radial bearings made of ceramic.
- Single-phase 230 V 50 Hz power supply.
Terminal box axially integrated in the motor.
- 2-pole, three-speed motor, with manual speed selection.
- **Insulation class** 180 (H).
- **Protection class** IP 44.

CONSTRUCTION CHARACTERISTICS

- Electric circulator pumps with in-line suction and discharge ports, designed for direct installation onto piping, with 1" ½ and 2" threaded connections.
- According to IEC 60335-1 and 60335-2-51 standards.

ACCESSORIES

- Pipe unions.
- Insulation shell.

INSTALLATION

- Suitable for installation in horizontal or vertical piping, in any position, provided that motor axis is horizontal.

TLCH SERIES IDENTIFICATION CODE

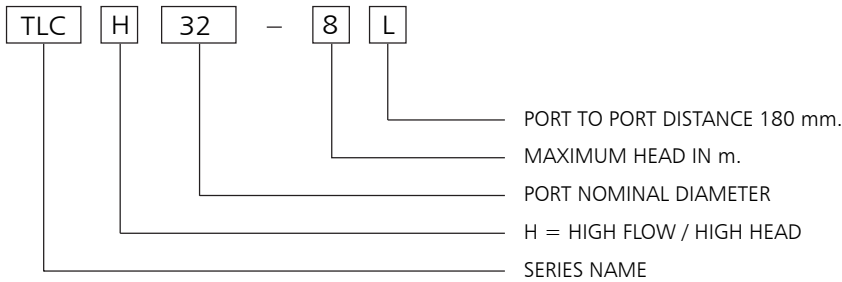

EXAMPLE : TLCH 32-8L

TLCH series circulator, high flow/head H version, port nominal diameter = 32, max head = 8 m, with port to port distance of 180 mm.

TABLE OF MATERIALS

PART	MATERIAL
Pump body	Cast iron cataphoretically coated
Impeller	Composite material
Shaft	Ceramics
Inner jacket	Stainless steel
Wear ring	Ceramics
Bearings	Ceramics
Gaskets	EPDM

tlch-2p50-en_a_tm

TLCH SERIES HYDRAULIC PERFORMANCE TABLE

PUMP TYPE	MAXIMUM ABSORBED POWER W	MAXIMUM ABSORBED CURRENT A	CAPACITOR		SPEED	Q = DELIVERY									
			μF	V		l/s 0	0,3	0,7	1,0	1,3	1,7	2,0	2,3	2,7	
230V 50Hz						m ³ /h 0	1,2	2,4	3,6	4,8	6,0	7,2	8,4	9,6	
H = TOTAL HEAD METRES COLUMN OF WATER															
TLCH 25-7L	220	1,03	8,0	400	1	5,8	5,1	4,2	3,1	1,9	1,1				
TLCH 32-7L	228	1,04			2	6,7	6,2	5,4	4,4	3,3	2,2	1,2			
	260	1,13			3	7,1	6,7	6,1	5,2	4,2	3,2	2,3	1,4		
TLCH 25-8L	260	1,23	8,0	400	1	6,6	5,9	4,7	3,1	1,8	0,8				
TLCH 32-8L	270	1,24			2	7,5	7,0	6,2	5,1	3,9	2,7	1,7			
	286	1,25			3	8,0	7,6	6,9	5,9	4,8	3,7	2,7	1,7		
TLCH 25-10L	283	1,35	8,0	400	1	8,3	7,0	5,0	2,7	1,1					
TLCH 32-10L	343	1,44			2	9,4	8,7	7,7	6,3	4,6	3,1	1,7			
	357	1,56			3	10,0	9,5	8,8	7,7	6,5	5,1	3,8	2,6	1,5	
TLCH 25-12L	285	1,36	8,0	400	1	7,8	6,5	4,5	2,2	0,7					
TLCH 32-12L	372	1,69			2	10,4	9,6	8,5	6,9	5,2	3,4	1,9			
	400	1,73			3	11,9	11,2	10,3	9,2	7,7	6,2	4,7	3,3	2,0	

Hydraulic performances in compliance with ISO 9906:2012 - Grade 3B (ex ISO 9906:1999 - Annex A)

tlch-2p50-en_d_th

**TLCH SERIES
SINGLE-PHASE OPERATING CHARACTERISTICS**

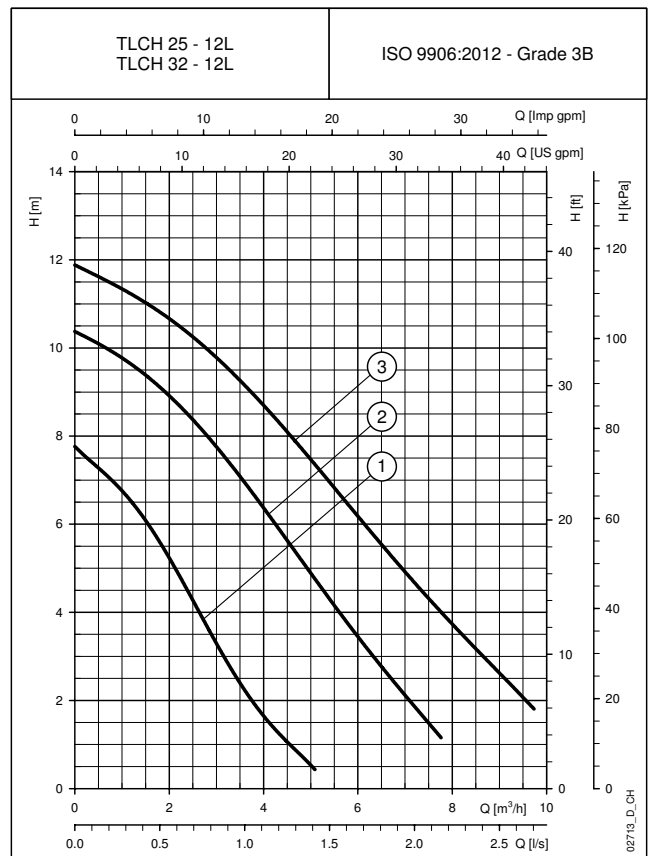
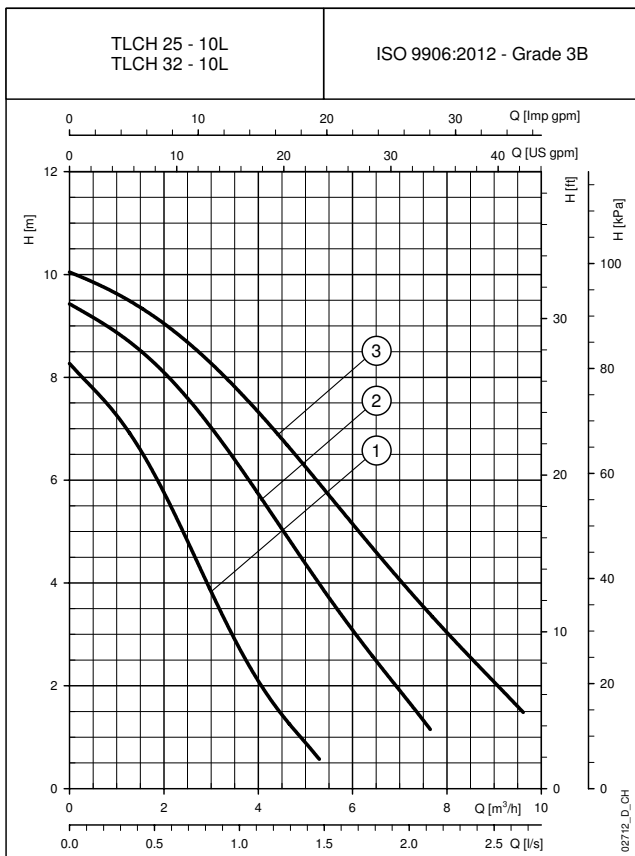
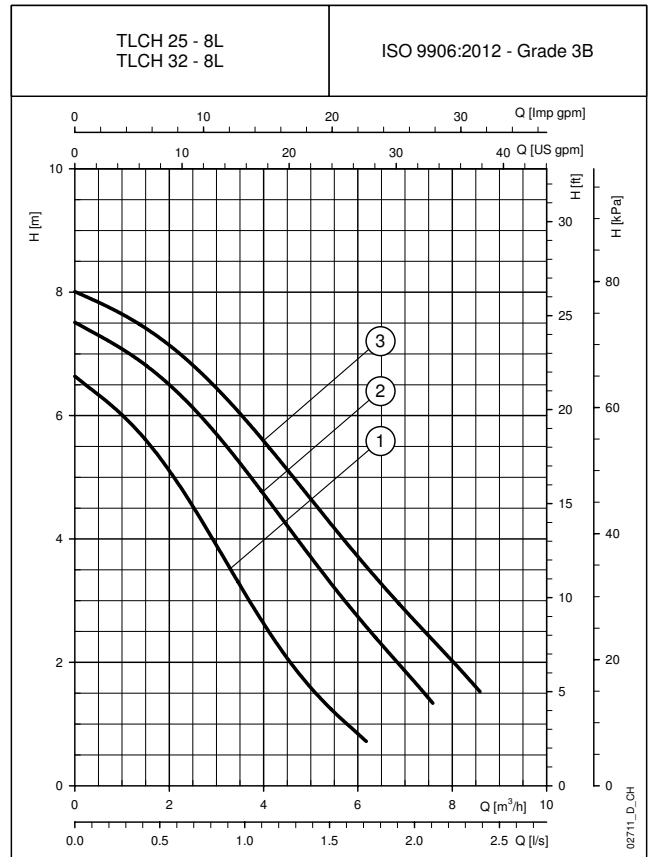
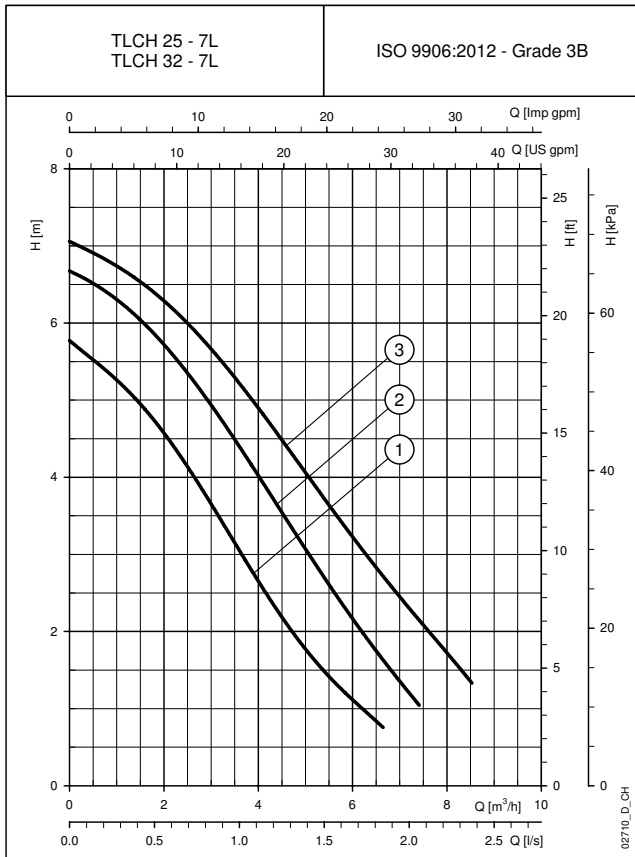

These performances are valid for liquids with density $\rho = 1.0 \text{ Kg/dm}^3$ and kinematic viscosity $\nu = 1 \text{ mm}^2/\text{sec}$.

**TLCH SERIES
DIMENSIONS AND WEIGHTS**

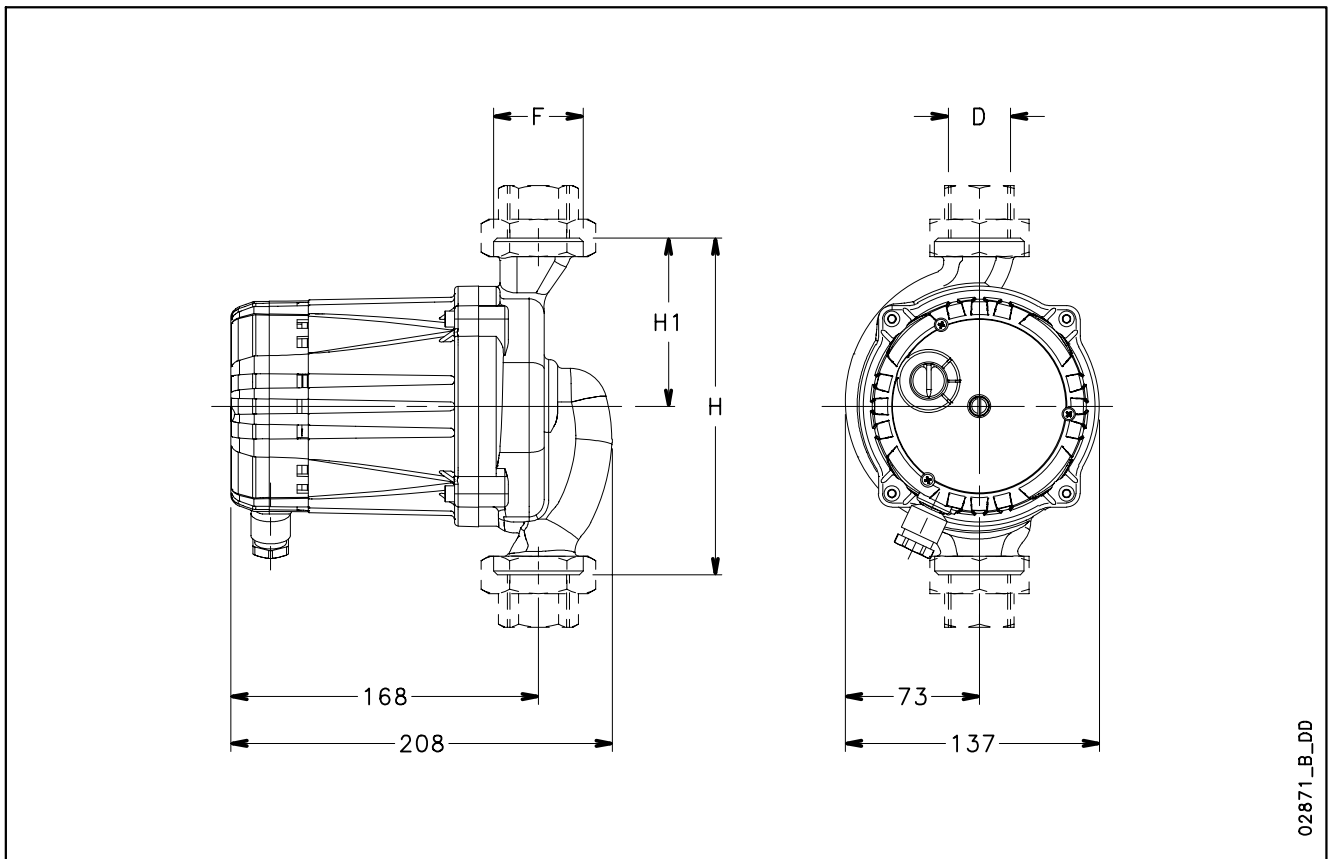

DIMENSIONS AND WEIGHTS TABLE

PUMP TYPE	DIMENSIONS (mm)					WEIGHT kg
	H	H1	D	F	DN	
TLCH 25-7L	180	90	1"	G 1 1/2"	25	6,5
TLCH 32-7L	180	90	1 1/4"	G 2"	32	6,6
TLCH 25-8L	180	90	1"	G 1 1/2"	25	6,5
TLCH 32-8L	180	90	1 1/4"	G 2"	32	6,6
TLCH 25-10L	180	90	1"	G 1 1/2"	25	6,5
TLCH 32-10L	180	90	1 1/4"	G 2"	32	6,6
TLCH 25-12L	180	90	1"	G 1 1/2"	25	6,5
TLCH 32-12L	180	90	1 1/4"	G 2"	32	6,6

tlch-2p50-en_c_td

Circulators for commercial systems

FLC Series



MARKET SECTORS

COMMERCIAL AND INDUSTRIAL.

APPLICATIONS

- Water circulation in heating, air conditioning and cooling systems.
- Pumping of hot/cold liquids, chemically or mechanically non-aggressive, non-explosive, without solids or fiber matter.

SPECIFICATIONS

PUMP

- **Flow rate:** up to 80 m³/h. (150 m³/h with both pumps running).
- **Head:** up to 20 m.
- **Temperature of pumped liquid:** -15°C ÷ +100°C or -15°C ÷ +110°C depending on models (see Product Range Chart).
Avoid condensation and ice formation.
- **Maximum operating pressure:** 10 bar (PN 10).
- **Impeller:** made of cast iron (except models up to FLC(G) 40-7(T), made of composite material).

MOTOR

- Wet rotor type, with bearings lubricated by the pumped liquid. Integrated automatic motor protection. In single-case twin pumps each motor has its own protection.
- Power supply either single-phase 230 V 50 Hz or three-phase 400 V 50 Hz.
- Four speed, with manual selector on the terminal board.
- Terminal board with set speed.
- **Insulation class** 155 (F).
- **Protection class** IP 44.

CONSTRUCTION CHARACTERISTICS

- Electric circulator pumps with in-line suction and discharge ports, designed for direct installation onto piping, with DN 40, 50, 65 and 80 mounting flanges (with pressure gauge connections).
- Single or twin pump design (with non-return valve on the suction side to allow the hydraulic changeover between the two pumps for the twin version). The two pumps can operate separately or in parallel.
- Rotor shaft made of perforated stainless steel.
By enabling water circulation this design ensures:
 - continuous degassing of the rotor chamber, with no need to perform this operation manually during startup;
 - bearing lubrication.
- According to IEC 60335-1 and 60335-2-51 standards.

FLC Series

ACCESSORIES

- Blind flanges.
- Counterflanges.

INSTALLATION

- Suitable for installation in horizontal or vertical piping, in any position provided that motor axis is horizontal.
- Never install the circulator with the terminal box under the motor(s) (6 o'clock).
- For the twin design installed on horizontal piping, periodic changeover is recommended in order to prevent the formation of water pockets at the top; as an alternative, install an air bleed valve on the flange.
- For installation onto vertical piping the flow should always be upward. If not it is recommended to install an air venting point in the higher point of the circuit at the suction side.

FLC SERIES IDENTIFICATION CODE

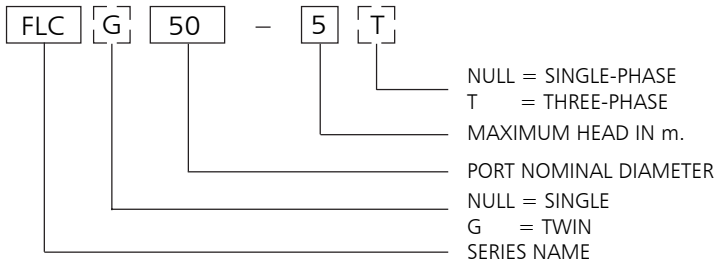

EXAMPLE : FLCG 50-5T

FLC series circulator, twin version, port nominal diameter = 50, max head = 5 m, three-phase version.

TABLE OF MATERIALS

PART	MATERIAL
Pump body	Cast iron
Impeller up to FLC(G) 40-7(T)	Composite material
Impeller from FLC(G) 40-10(T)	Cast iron
Shaft	Stainless steel
Jacket	Stainless steel
Bearings	Graphite
Gaskets	EPDM

fic-2p50-en_a_tm

FLC SERIES (SINGLE VERSION, SINGLE-PHASE) HYDRAULIC PERFORMANCE TABLE

PUMP TYPE	MAXIMUM ABSORBED POWER W	MAXIMUM ABSORBED CURRENT A	CAPACITOR		SPEED	Q = DELIVERY												
			μF	V		l/s 0	1,4	2,8	4,9	6,9	9,0	11,1	13,2	15,3				
						m ³ /h 0	5,0	10,0	17,5	25,0	32,5	40,0	47,5	55,0				
230V 50Hz						H = TOTAL HEAD METRES COLUMN OF WATER												
* FLC 40-5	128	0,59	6,0	400	1	4,0	2,5											
	136	0,61			2	4,0	3,0	0,3										
	143	0,63			3	4,1	3,2	0,4										
	154	0,70			4	4,1	3,3	0,6										
FLC 40-7	288	1,30	8,0	400	1	7,9	3,9											
	319	1,43			2	8,2	5,7	1,6										
	326	1,44			3	8,3	6,4	2,9										
	326	1,43			4	8,3	6,7	3,6										
FLC 40-10	490	2,24	30,0	400	1	6,8	4,8	2,5										
	585	2,61			2	8,4	6,8	4,3	0,9									
	679	3,02			3	9,3	8,1	6,1	2,3									
	734	3,21			4	9,7	8,7	7,3	4,0									
FLC 50-5	245	1,15	16,0	400	1	4,2	3,3	1,9										
	277	1,26			2	4,7	4,3	3,0	0,3									
	296	1,36			3	4,9	4,6	3,5	1,0									
	311	1,56			4	4,9	4,7	3,8	1,5									
FLC 50-8	459	2,08	25,0	400	1	6,6	5,2	3,1	0,9									
	558	2,50			2	7,7	6,9	4,9	1,9									
	650	2,89			3	8,2	7,9	6,5	3,4	0,8								
	684	3,03			4	8,5	8,4	7,5	4,9	1,9								
FLC 50-10	497	2,24	30,0	400	1	5,6	4,1	2,6	0,7									
	600	2,69			2	7,4	6,0	4,0	1,7									
	719	3,15			3	8,3	7,3	5,4	2,7	0,3								
	800	3,57			4	9,0	8,5	7,1	4,6	1,8								
FLC 50-13	810	3,66	40,0	400	1	9,6	7,9	5,7	2,8									
	986	4,46			2	11,1	10,0	8,0	4,5	1,3								
	1176	5,27			3	11,8	11,0	9,4	6,3	2,8								
	1306	5,88			4	12,4	11,9	10,8	8,5	5,4	1,4							
FLC 65-7	506	2,23	30,0	400	1	4,5	3,5	2,5	1,3									
	590	2,62			2	5,8	4,9	3,7	2,2	0,8								
	657	2,99			3	6,6	5,9	4,8	3,2	1,6								
	711	3,24			4	7,1	6,6	5,8	4,3	2,8	1,1							
FLC 65-10	624	2,77	30,0	400	1	6,5	5,7	4,5	2,8	1,4								
	725	3,19			2	7,4	6,8	5,8	4,0	2,3	0,8							
	826	3,66			3	7,8	7,5	6,6	5,0	3,2	1,5							
	920	4,33			4	8,1	8,0	7,3	5,9	4,2	2,2							
FLC 65-12	801	3,61	40,0	400	1	8,1	6,8	5,1	3,2	1,8	0,4							
	970	4,36			2	9,5	8,6	7,1	4,7	2,9	1,3							
	1159	5,21			3	10,3	9,6	8,4	6,3	4,2	2,3	0,7						
	1296	5,74			4	10,8	10,5	9,7	8,1	6,3	4,3	2,1						
FLC 80-8	650	2,80	30,0	400	1	3,6	3,4	3,1	2,5	1,9	1,3	0,6						
	729	3,15			2	4,3	4,2	3,8	3,3	2,6	1,9	1,1						
	808	3,54			3	5,0	4,8	4,5	3,9	3,2	2,4	1,6						
	902	4,28			4	5,5	5,4	5,1	4,4	3,7	2,9	2,0	1,0					
FLC 80-10	807	3,63	40,0	400	1	4,6	4,4	3,9	3,1	2,2	1,6	1,0						
	986	4,43			2	6,0	5,7	5,2	4,3	3,1	2,1	1,6	1,0					
	1186	5,32			3	7,2	6,9	6,5	5,5	4,4	3,3	2,4	1,8					
	1330	5,87			4	8,1	7,9	7,6	7,0	6,1	5,1	4,1	3,1	1,9				

* Performances according to standard EN 1151-1.

fcm-2p50-en_c_th

Hydraulic performances in compliance with ISO 9906:2012 - Grade 3B (ex ISO 9906:1999 - Annex A)

FLC40..T - FLC50..T SERIES (SINGLE VERSION, THREE-PHASE) HYDRAULIC PERFORMANCE TABLE

PUMP TYPE 400V 50Hz	MAXIMUM ABSORBED POWER W	MAXIMUM ABSORBED CURRENT A	SPEED	Q = DELIVERY															
				1/5 0	0,6	1,1	1,7	2,2	2,8	3,3	3,9	4,4	5,6	6,7	7,8	8,9	10,0	11,1	
				m ³ /h 0	2	4	6	8	10	12	14	16	20	24	28	32	36	40	
H = TOTAL HEAD METRES COLUMN OF WATER																			
* FLC 40-5T	105	0,17	1	3,6	3,1	2,5	1,6	0,7											
	118	0,21	2	3,7	3,3	2,8	2,1	1,1											
	135	0,25	3	3,9	3,5	3,2	2,5	1,4	0,2										
	150	0,33	4	3,9	3,7	3,4	2,7	1,7	0,5										
FLC 40-7T	209	0,33	1	7,5	5,5	4,6	3,3	1,9	0,7										
	252	0,40	2	7,8	6,3	5,5	4,3	2,9	1,5	0,1									
	296	0,49	3	8,1	6,9	6,3	5,4	4,1	2,5	1,0									
	336	0,61	4	8,3	7,4	7,0	6,3	5,1	3,6	2,0	0,1								
FLC 40-10T	471	0,77	1	7,8	7,0	6,4	5,8	5,0	4,1	3,1	2,3	1,5							
	570	0,92	2	8,5	7,9	7,4	6,9	6,2	5,4	4,5	3,5	2,6	0,9						
	645	1,03	3	9,0	8,7	8,2	7,7	7,1	6,4	5,7	4,9	4,0	2,0						
	699	1,17	4	9,5	9,2	8,8	8,4	7,9	7,3	6,6	5,9	5,0	3,1	1,0					
FLC 50-5T	221	0,43	1	4,3	4,1	3,8	3,3	2,8	2,2	1,6	1,0	0,2							
	264	0,51	2	4,5	4,5	4,2	3,8	3,4	2,9	2,4	1,7	1,0							
	304	0,62	3	4,7	4,8	4,6	4,2	3,9	3,5	3,0	2,4	1,7							
	334	0,78	4	4,8	5,0	4,8	4,5	4,2	3,8	3,4	2,8	2,2	0,5						
FLC 50-8T	495	0,80	1	6,9	6,7	6,5	6,1	5,6	4,9	4,2	3,4	2,6	1,2						
	550	0,88	2	7,6	7,5	7,3	6,9	6,4	5,8	5,1	4,4	3,6	2,1	0,7					
	621	1,00	3	8,2	8,1	8,0	7,7	7,3	6,9	6,3	5,6	4,9	3,2	1,5					
	669	1,13	4	8,5	8,5	8,5	8,3	8,0	7,6	7,1	6,5	5,8	4,2	2,4	0,8				
FLC 50-10T	508	0,83	1	6,9	6,6	6,0	5,4	4,7	4,1	3,5	2,9	2,3	1,2						
	622	1,00	2	7,9	7,7	7,3	6,7	6,1	5,5	4,8	4,2	3,5	2,2	0,9					
	724	1,17	3	8,6	8,5	8,2	7,7	7,1	6,5	5,8	5,2	4,5	3,2	1,7	0,3				
	822	1,39	4	9,4	9,4	9,2	8,8	8,3	7,7	7,1	6,5	5,8	4,5	2,9	1,2				
FLC 50-13T	852	1,39	1	10,6	10,2	9,7	9,1	8,4	7,7	6,9	6,2	5,5	3,9						
	1017	1,68	2	11,6	11,4	11,0	10,5	9,9	9,3	8,6	7,8	7,0	5,4	3,7	1,8				
	1180	1,94	3	12,4	12,2	11,9	11,5	11,0	10,4	9,8	9,2	8,4	6,9	5,1	3,2	1,1			
	1338	2,40	4	13,2	13,2	13,0	12,7	12,3	11,8	11,2	10,6	9,9	8,4	6,7	4,7	2,5			
FLC 50-18T	1507	2,40	1	16,5	16,6	16,2	15,6	14,9	14,1	13,2	12,3	11,4	9,4	7,1	4,4	1,6			
	1768	2,80	2	17,8	18,0	17,8	17,4	16,8	16,1	15,3	14,4	13,6	11,7	9,6	7,0	4,1	1,0		
	2017	3,20	3	18,7	19,0	19,0	18,7	18,3	17,7	17,0	16,3	15,5	13,7	11,7	9,2	6,4	3,2		
	2232	3,66	4	19,6	20,0	20,0	19,8	19,5	19,0	18,5	17,9	17,2	15,7	13,8	11,4	8,6	5,4	1,8	

* Performances according to standard EN 1151-1.

fict-1-2p50-en_c_th

Hydraulic performances in compliance with ISO 9906:2012 - Grade 3B (ex ISO 9906:1999 - Annex A)

FLC65..T - FLC80..T SERIES (SINGLE VERSION, THREE-PHASE) HYDRAULIC PERFORMANCE TABLE

PUMP TYPE 400V 50Hz	MAXIMUM ABSORBED POWER W	MAXIMUM ABSORBED CURRENT A	SPEED	Q = DELIVERY																
				1/5 0	1,4	2,8	4,2	5,6	6,9	8,3	9,7	11,1	12,5	13,9	15,3	16,7	19,4	22,2		
				m ³ /h 0	5	10	15	20	25	30	35	40	45	50	55	60	70	80		
H = TOTAL HEAD METRES COLUMN OF WATER																				
FLC 65-7T	458	0,73	1	5,3	4,5	3,6	2,7	1,8	0,8											
	547	0,89	2	5,9	5,2	4,2	3,3	2,4	1,3											
	628	1,02	3	6,5	6,0	5,1	4,2	3,2	2,1	0,9										
	702	1,22	4	7,0	6,6	5,9	5,0	4,0	2,9	1,6										
FLC 65-10T	640	1,04	1	7,1	6,3	5,2	4,2	3,2	2,1	1,0										
	761	1,24	2	7,8	7,2	6,2	5,2	4,2	3,0	1,8	0,6									
	874	1,45	3	8,4	8,0	7,1	6,1	5,0	3,8	2,6	1,2									
	1020	1,97	4	9,0	8,7	7,9	6,9	5,9	4,7	3,4	2,0									
FLC 65-12T	892	1,43	1	9,1	8,3	7,1	5,9	4,8	3,6	2,4	1,2									
	1070	1,70	2	10,1	9,6	8,6	7,4	6,2	5,0	3,8	2,4	1,0								
	1229	1,96	3	10,9	10,5	9,6	8,5	7,4	6,2	4,9	3,5	2,0								
	1385	2,32	4	11,8	11,6	10,9	9,9	8,7	7,6	6,3	4,9	3,3	1,6							
FLC 65-16T	1424	2,26	1	13,0	12,4	11,4	10,2	8,8	7,4	5,9	4,3	2,6	0,8							
	1651	2,61	2	14,0	13,6	12,8	11,7	10,5	9,0	7,5	6,0	4,2	2,4							
	1862	2,95	3	14,8	14,6	13,9	13,0	11,8	10,5	9,0	7,4	5,6	3,7	1,5						
	2029	3,37	4	15,3	15,4	14,9	14,0	12,9	11,6	10,2	8,7	6,9	5,0	2,8						
FLC 80-8T	629	1,03	1	4,0	3,9	3,6	3,2	2,8	2,3	1,9	1,4	0,9								
	765	1,23	2	4,9	4,8	4,5	4,1	3,6	3,1	2,6	2,0	1,5	0,9							
	884	1,46	3	5,5	5,4	5,1	4,7	4,2	3,7	3,2	2,6	2,1	1,4							
	1033	1,97	4	6,2	6,1	5,8	5,4	4,9	4,3	3,8	3,2	2,6	1,9	1,2						
FLC 80-10T	889	1,45	1	6,1	5,9	5,5	5,0	4,4	3,9	3,3	2,7	2,1	1,4							
	1086	1,73	2	7,1	7,0	6,6	6,2	5,6	5,1	4,5	3,9	3,3	2,6	1,8						
	1238	1,99	3	7,9	7,8	7,5	7,1	6,5	6,0	5,3	4,7	4,1	3,4	2,7	2,0					
	1390	2,35	4	8,8	8,7	8,5	8,1	7,6	7,0	6,4	5,8	5,1	4,4	3,7	2,9	2,0				
FLC 80-12T	1393	2,21	1	8,8	8,5	8,1	7,6	7,0	6,5	5,8	5,2	4,5	3,8	3,1	2,4	1,7				
	1611	2,54	2	9,7	9,4	9,1	8,7	8,2	7,7	7,0	6,4	5,7	4,9	4,2	3,4	2,6				
	1806	2,88	3	10,5	10,3	10,0	9,6	9,1	8,6	8,0	7,3	6,7	5,9	5,2	4,3	3,5	1,6			
	2005	3,35	4	11,4	11,3	11,0	10,7	10,2	9,7	9,1	8,4	7,7	6,9	6,1	5,3	4,4	2,3			
FLC 80-15T	1647	2,62	1	10,2	9,7	9,2	8,7	8,1	7,4	6,7	6,0	5,3	4,6	4,0	3,3	2,7				
	1959	3,09	2	11,4	11,0	10,7	10,2	9,7	9,1	8,5	7,7	7,0	6,2	5,5	4,7	4,0	2,5			
	2263	3,58	3	12,5	12,2	11,9	11,6	11,1	10,6	10,0	9,3	8,5	7,7	6,9	6,1	5,4	3,8			
	2537	4,15	4	13,5	13,4	13,2	12,9	12,6	12,2	11,6	11,0	10,3	9,5	8,7	7,8	7,0	5,2	3,3		

Hydraulic performances in compliance with ISO 9906:2012 - Grade 3B (ex ISO 9906:1999 - Annex A)

fict-2-2p50-en_c_th

FLCG SERIES (TWIN VERSION, SINGLE-PHASE) HYDRAULIC PERFORMANCE TABLE (SINGLE OPERATION)

PUMP TYPE 230V 50Hz	MAXIMUM ABSORBED POWER W	MAXIMUM ABSORBED CURRENT A	CAPACITOR		SPEED	Q = DELIVERY																	
			μF	V		l/s 0	1,1	2,2	3,3	5,0	6,9	9,7	12,5	15,3									
						m ³ /h 0	4,0	8,0	12,0	18,0	25,0	35,0	45,0	55,0									
H = TOTAL HEAD METRES COLUMN OF WATER																							
* FLCG 40-5	123	0,56	6,0	400	1	3,9	2,9	1,0															
	130	0,58			2	4,0	3,2	1,4															
	139	0,61			3	4,0	3,4	1,7															
	147	0,67			4	4,0	3,5	1,8															
FLCG 40-7	273	1,28	8,0	400	1	7,3	4,8	1,3															
	293	1,38			2	7,6	5,9	2,7	0,4														
	303	1,39			3	7,7	6,5	4,1	1,2														
	303	1,37			4	7,8	6,8	4,7	1,7														
FLCG 40-10	498	2,23	30,0	400	1	6,5	5,1	3,2	1,6														
	599	2,65			2	8,0	6,9	5,2	3,1														
	671	3,08			3	8,8	8,0	6,7	5,0	2,0													
	730	3,34			4	9,0	8,4	7,4	6,1	3,6													
FLCG 50-5	245	1,15	16,0	400	1	4,2	3,5	2,3	0,9														
	267	1,25			2	4,7	4,3	3,2	1,7														
	298	1,34			3	4,9	4,6	3,8	2,6	0,2													
	307	1,55			4	4,9	4,7	4,0	2,9	0,4													
FLCG 50-8	459	2,06	25,0	400	1	6,6	5,1	3,4	2,1	0,4													
	548	2,44			2	7,8	6,8	5,0	3,4	1,3													
	606	2,72			3	8,4	7,8	6,5	5,0	2,7													
	633	2,83			4	8,6	8,3	7,3	6,0	3,8	0,7												
FLCG 50-10	497	2,23	30,0	400	1	5,7	4,2	2,9	1,8	0,1													
	595	2,65			2	7,7	6,2	4,5	3,1	1,0													
	702	3,11			3	8,7	7,5	6,0	4,4	2,1													
	774	3,42			4	9,3	8,6	7,5	6,2	4,0	0,8												
FLCG 65-7	489	2,20	30,0	400	1	3,6	3,0	2,4	1,8	0,9													
	592	2,62			2	4,8	4,3	3,6	2,9	1,8	0,5												
	684	3,01			3	5,6	5,1	4,5	3,8	2,6	1,2												
	740	3,25			4	6,1	5,8	5,3	4,8	3,7	2,2												
FLCG 65-10	634	2,82	30,0	400	1	5,6	5,0	4,2	3,3	2,1	0,8												
	746	3,36			2	6,5	6,0	5,2	4,3	3,0	1,5												
	882	3,97			3	7,0	6,8	6,1	5,3	4,0	2,4												
	994	4,68			4	7,4	7,3	6,8	6,1	5,0	3,5	1,0											
FLCG 65-12	812	3,68	40,0	400	1	6,8	5,9	4,7	3,6	2,3	0,9												
	997	4,53			2	8,5	7,8	6,6	5,3	3,5	1,8												
	1208	5,46			3	9,4	9,0	8,1	6,9	5,1	3,0	0,5											
	1389	6,19			4	10,2	10,0	9,4	8,6	7,3	5,6	2,7											
FLCG 80-4	533	2,41	30,0	400	1	3,7	3,5	3,2	3,0	2,5	1,8	0,9											
	569	2,56			2	4,1	4,0	3,8	3,6	3,2	2,6	1,6											
	587	2,66			3	4,2	4,1	4,0	3,8	3,5	3,0	2,0	0,8										
	595	2,85			4	4,3	4,2	4,1	4,0	3,7	3,3	2,4	1,2										
FLCG 80-8	639	2,88	30,0	400	1	3,0	2,9	2,7	2,5	2,1	1,5												
	765	3,42			2	3,8	3,7	3,5	3,2	2,8	2,2	1,1											
	881	3,97			3	4,6	4,5	4,2	3,9	3,5	2,9	1,7											
	973	4,62			4	5,4	5,3	5,0	4,6	4,1	3,4	2,3	1,0										
FLCG 80-10	805	3,60	40,0	400	1	4,3	4,1	3,7	3,2	2,7	2,1	1,1											
	962	4,30			2	5,6	5,3	4,8	4,3	3,6	3,0	2,1	0,9										
	1144	5,08			3	6,6	6,4	5,9	5,4	4,7	4,0	2,9	1,5										
	1263	5,61			4	7,8	7,6	7,2	6,8	6,1	5,3	4,2	2,7	1,0									

* Performances according to standard EN 1151-1.

flcgm-2p50S-en_c_th

Hydraulic performances in compliance with ISO 9906:2012 - Grade 3B (ex ISO 9906:1999 - Annex A)

FLCG SERIES (TWIN VERSION, SINGLE-PHASE) HYDRAULIC PERFORMANCE TABLE (PARALLEL OPERATION)

PUMP TYPE	MAXIMUM ABSORBED POWER W*	MAXIMUM ABSORBED CURRENT A*	CAPACITOR		SPEED	Q = DELIVERY								
			μF	V		l/s 0	2,8	4,2	5,6	9,7	13,9	18,8	22,2	27,8
						m ³ /h 0	10,0	15,0	20,0	35,0	50,0	67,5	80,0	100,0
230V 50Hz						H = TOTAL HEAD METRES COLUMN OF WATER								
** FLCG 40-5	123	0,56	6,0	400	1	3,9	2,3	1,0						
	130	0,58			2	4,0	2,7	1,4						
	139	0,61			3	4,0	2,9	1,6						
	147	0,67			4	4,0	3,0	1,7	0,1					
FLCG 40-7	273	1,28	8,0	400	1	7,3	3,3	1,1	0,2					
	293	1,38			2	7,6	4,9	2,5	0,9					
	303	1,39			3	7,7	5,8	3,9	1,9					
	303	1,37			4	7,8	6,2	4,5	2,4					
FLCG 40-10	498	2,23	30,0	400	1	6,5	4,0	2,6	1,4					
	599	2,65			2	8,0	6,0	4,5	2,9					
	671	3,08			3	8,8	7,4	6,2	4,8	0,3				
	730	3,34			4	9,0	7,9	7,0	5,9	1,9				
FLCG 50-5	245	1,15	16,0	400	1	4,2	3,1	2,2	1,2					
	267	1,25			2	4,7	3,9	3,1	2,1					
	298	1,34			3	4,9	4,3	3,8	3,0					
	307	1,55			4	4,9	4,5	4,0	3,3					
FLCG 50-8	459	2,06	25,0	400	1	6,6	4,4	3,3	2,4					
	548	2,44			2	7,8	6,1	4,9	3,8	0,9				
	606	2,72			3	8,4	7,3	6,4	5,4	2,2				
	633	2,83			4	8,6	8,0	7,2	6,4	3,3				
FLCG 50-10	497	2,23	30,0	400	1	5,7	3,6	2,8	2,1	0,5				
	595	2,65			2	7,7	5,5	4,4	3,4	0,5				
	702	3,11			3	8,7	6,9	5,8	4,7	1,5				
	774	3,42			4	9,3	8,2	7,3	6,5	3,2				
FLCG 65-7	489	2,20	30,0	400	1	3,6	2,6	2,0	1,5					
	592	2,62			2	4,8	3,8	3,1	2,5	0,5				
	684	3,01			3	5,6	4,6	4,0	3,3	1,2				
	740	3,25			4	6,1	5,4	5,0	4,4	2,2				
FLCG 65-10	634	2,82	30,0	400	1	5,6	4,8	4,3	3,7	2,2	0,8			
	746	3,36			2	6,5	5,8	5,3	4,7	3,1	1,5			
	882	3,97			3	7,0	6,6	6,2	5,7	4,1	2,4	0,5		
	994	4,68			4	7,4	7,2	6,9	6,5	5,1	3,5	1,3		
FLCG 65-12	812	3,68	40,0	400	1	6,8	5,6	4,8	4,1	2,3	0,7			
	997	4,53			2	8,5	7,5	6,7	5,9	3,5	1,6			
	1208	5,46			3	9,4	8,7	8,1	7,4	5,1	2,8	0,6		
	1389	6,19			4	10,2	9,9	9,5	9,0	7,3	5,4	2,8	0,9	
FLCG 80-4	533	2,41	30,0	400	1	3,7	3,4	3,2	3,0	2,3	1,5	0,6		
	569	2,56			2	4,1	3,9	3,8	3,7	3,1	2,3	1,3	0,4	
	587	2,66			3	4,2	4,1	4,0	3,8	3,4	2,7	1,6	0,8	
	595	2,85			4	4,3	4,2	4,1	4,0	3,6	3,0	2,1	1,2	
FLCG 80-8	639	2,88	30,0	400	1	3,0	2,8	2,7	2,5	2,0	1,2			
	765	3,42			2	3,8	3,6	3,5	3,3	2,7	2,0	0,9		
	881	3,97			3	4,6	4,4	4,2	4,0	3,4	2,6	1,4	0,7	
	973	4,62			4	5,4	5,2	5,0	4,7	3,9	3,1	2,0	1,0	
FLCG 80-10	805	3,60	40,0	400	1	4,3	3,9	3,6	3,3	2,5	1,8	0,8	0,6	
	962	4,30			2	5,6	5,1	4,8	4,4	3,4	2,7	1,7	0,9	
	1144	5,08			3	6,6	6,2	5,9	5,5	4,5	3,7	2,5	1,5	1,2
	1263	5,61			4	7,8	7,4	7,1	6,8	5,9	5,0	3,8	2,7	0,8

* Electric data refer to single motor.

flcgm-2p50P-en_c_th

** Performances according to standard EN 1151-1.

Hydraulic performances in compliance with ISO 9906:2012 - Grade 3B (ex ISO 9906:1999 - Annex A)

FLCG40..T - FLCG50..T SERIES (TWIN VERSION, THREE-PHASE) HYDRAULIC PERFORMANCE TABLE (SINGLE OPERATION)

PUMP TYPE 400V 50Hz	MAXIMUM ABSORBED POWER W	MAXIMUM ABSORBED CURRENT A	SPEED	Q = DELIVERY															
				l/s 0	0,6	1,1	1,7	2,2	2,8	3,3	3,9	4,4	5,0	5,6	6,1	6,7	7,2	7,8	
				m ³ /h 0	2	4	6	8	10	12	14	16	18	20	22	24	26	28	
H = TOTAL HEAD METRES COLUMN OF WATER																			
* FLCG 40-5T	100	0,17	1	3,6	3,1	2,5	1,6	0,7											
	114	0,20	2	3,7	3,4	2,8	2,0	1,0											
	129	0,25	3	3,9	3,6	3,2	2,4	1,4	0,2										
	143	0,33	4	4,0	3,8	3,4	2,7	1,6	0,4										
FLCG 40-7T	183	0,30	1	6,4	5,2	4,2	2,9	1,6	0,4										
	215	0,36	2	6,8	5,8	4,9	3,7	2,4	1,0										
	249	0,44	3	7,2	6,4	5,7	4,6	3,2	1,8	0,1									
	265	0,57	4	7,4	6,8	6,2	5,3	4,0	2,4	0,7									
FLCG 40-10T	468	0,78	1	7,3	6,8	6,1	5,3	4,5	3,6	2,8	2,0	1,2	0,5						
	575	0,93	2	7,9	7,5	7,0	6,3	5,6	4,9	4,0	3,2	2,3	1,5	0,7					
	666	1,06	3	8,5	8,2	7,8	7,3	6,6	6,0	5,2	4,4	3,6	2,7	1,8	0,9				
	731	1,22	4	8,9	8,7	8,3	7,9	7,4	6,8	6,1	5,4	4,6	3,7	2,8	1,9	0,9			
FLCG 50-5T	224	0,44	1	4,3	4,0	3,5	2,9	2,4	1,8	1,1	0,3								
	266	0,51	2	4,6	4,4	4,1	3,6	3,1	2,5	1,8	1,0	0,2							
	308	0,62	3	4,9	4,7	4,5	4,1	3,7	3,1	2,4	1,7	0,9							
	335	0,78	4	5,1	4,9	4,7	4,4	4,0	3,5	2,9	2,2	1,4	0,5						
FLCG 50-8T	440	0,71	1	7,0	6,7	6,1	5,4	4,7	4,0	3,3	2,6	2,0	1,2						
	514	0,83	2	7,7	7,5	7,0	6,4	5,7	5,1	4,4	3,7	3,0	2,2	1,4					
	579	0,94	3	8,3	8,2	7,8	7,3	6,7	6,1	5,5	4,8	4,0	3,2	2,4	1,5				
	626	1,07	4	8,7	8,6	8,4	7,9	7,4	6,9	6,2	5,6	4,9	4,1	3,3	2,4	1,4			
FLCG 50-10T	479	0,78	1	7,3	6,7	6,0	5,3	4,7	4,0	3,4	2,7	2,0	1,3	0,5					
	581	0,98	2	8,1	7,7	7,1	6,6	6,0	5,3	4,6	3,9	3,2	2,4	1,5	0,7				
	674	1,09	3	8,8	8,5	8,0	7,4	6,8	6,2	5,6	4,9	4,2	3,4	2,5	1,5	0,6			
	767	1,31	4	9,6	9,4	9,0	8,5	8,0	7,4	6,8	6,2	5,4	4,6	3,7	2,7	1,6	0,6		

* Performances according to standard EN 1151-1.

flcgt-1-2p50S-en_c_th

Hydraulic performances in compliance with ISO 9906:2012 - Grade 3B (ex ISO 9906:1999 - Annex A)

FLCG65..T - FLCG80..T SERIES (TWIN VERSION, THREE-PHASE) HYDRAULIC PERFORMANCE TABLE (SINGLE OPERATION)

PUMP TYPE 400V 50Hz	MAXIMUM ABSORBED POWER W	MAXIMUM ABSORBED CURRENT A	SPEED	Q = DELIVERY															
				l/s 0	1,4	2,8	4,2	5,6	6,9	8,3	9,7	11,1	12,5	13,9	15,3	16,7	19,4	22,2	
				m ³ /h 0	5	10	15	20	25	30	35	40	45	50	55	60	70	80	
				H = TOTAL HEAD METRES COLUMN OF WATER															
FLCG 65-7T	475	0,77	1	4,7	4,0	3,1	2,2	1,4											
	578	0,93	2	5,3	4,6	3,7	2,8	1,9											
	668	1,08	3	5,9	5,4	4,6	3,7	2,7	1,7	0,5									
	807	1,39	4	6,3	5,9	5,0	4,1	3,1	2,0	0,8									
FLCG 65-10T	673	1,08	1	6,3	5,8	4,6	3,6	2,6	1,6	0,5									
	803	1,29	2	7,2	6,7	5,8	4,7	3,6	2,4	1,2									
	930	1,52	3	7,8	7,4	6,6	5,5	4,4	3,2	2,0	0,7								
	1079	2,02	4	8,5	8,3	7,4	6,4	5,3	4,1	2,8	1,4								
FLCG 65-12T	863	1,42	1	7,9	7,1	6,0	4,9	3,9	2,8	1,6	0,5								
	1044	1,68	2	8,8	8,1	7,2	6,2	5,1	4,0	2,8	1,5								
	1205	1,95	3	9,4	8,9	8,1	7,1	6,1	5,0	3,8	2,4	1,0							
	1353	2,30	4	10,1	9,7	9,0	8,1	7,2	6,1	4,9	3,5	2,1							
FLCG 65-16T	1511	2,40	1	11,6	11,0	9,8	8,6	7,3	6,0	4,7	3,1	1,4							
	1760	2,80	2	12,7	12,3	11,3	10,1	8,9	7,6	6,3	4,7	2,9	1,1						
	2002	3,16	3	13,5	13,4	12,5	11,4	10,2	9,0	7,7	6,2	4,5	2,5						
	2152	3,60	4	14,4	14,3	13,6	12,6	11,5	10,3	9,0	7,6	5,9	3,9	1,8					
FLCG 80-4T	396	0,74	1	3,7	3,5	3,2	2,9	2,6	2,1	1,7	1,2	0,6							
	439	0,86	2	4,0	3,8	3,6	3,3	3,0	2,6	2,1	1,6	1,0							
	497	1,04	3	4,2	4,0	3,8	3,6	3,3	2,9	2,4	1,9	1,3							
	530	1,32	4	4,3	4,2	4,1	3,9	3,6	3,2	2,7	2,2	1,6	0,9						
FLCG 80-8T	649	1,05	1	4,2	3,9	3,5	3,0	2,6	2,2	1,7	1,1	0,6							
	774	1,26	2	5,0	4,7	4,2	3,8	3,3	2,8	2,3	1,7	1,1							
	888	1,48	3	5,7	5,4	4,9	4,3	3,8	3,4	2,8	2,3	1,6	0,9						
	1043	1,98	4	6,4	6,2	5,7	5,1	4,6	4,0	3,5	2,9	2,3	1,5						
FLCG 80-10T	839	1,34	1	5,7	5,2	4,8	4,4	4,0	3,5	3,0	2,4	1,8	1,2						
	987	1,58	2	6,7	6,2	5,7	5,3	4,9	4,4	3,8	3,2	2,6	1,9	1,2					
	1109	1,79	3	7,4	6,9	6,5	6,1	5,6	5,1	4,6	3,9	3,3	2,6	1,8					
	1259	2,12	4	8,4	7,8	7,4	7,0	6,5	6,0	5,4	4,8	4,1	3,3	2,5	1,6				
FLCG 80-12T	1380	2,15	1	8,6	8,4	7,9	7,2	6,6	6,0	5,4	4,8	4,2	3,3	2,5	1,6				
	1553	2,46	2	9,9	9,5	9,0	8,4	7,8	7,2	6,6	5,9	5,2	4,4	3,5	2,6	1,8			
	1739	2,77	3	10,8	10,3	9,8	9,3	8,8	8,2	7,5	6,8	6,1	5,3	4,4	3,5	2,6			
	1931	3,24	4	11,6	11,2	10,7	10,3	9,8	9,2	8,5	7,8	7,0	6,2	5,3	4,3	3,3			
FLCG 80-15T	1780	2,84	1	10,2	9,5	9,0	8,4	7,8	7,2	6,5	5,8	5,0	4,3	3,5	2,7	1,8			
	2117	3,36	2	11,5	11,0	10,5	10,0	9,4	8,8	8,2	7,5	6,7	5,9	5,1	4,2	3,3			
	2463	3,89	3	12,7	12,2	11,8	11,3	10,8	10,3	9,7	9,0	8,3	7,5	6,7	5,8	4,8	2,8		
	2735	4,92	4	13,9	13,5	13,1	12,7	12,2	11,7	11,2	10,6	10,0	9,2	8,4	7,5	6,6	4,4	2,1	

Hydraulic performances in compliance with ISO 9906:2012 - Grade 3B (ex ISO 9906:1999 - Annex A)

flcgt-2-2p505-en_c_th

**FLCG40..T - FLCG50..T SERIES (TWIN VERSION, THREE-PHASE)
HYDRAULIC PERFORMANCE TABLE
(PARALLEL OPERATION)**

PUMP TYPE 400V 50Hz	MAXIMUM ABSORBED POWER W*	MAXIMUM ABSORBED CURRENT A*	SPEED	Q = DELIVERY															
				l/s 0	0,6	1,1	1,7	2,2	2,8	3,9	5,0	6,1	7,2	8,3	9,4	10,6	11,7	12,8	
				m ³ /h 0	2	4	6	8	10	14	18	22	26	30	34	38	42	46	
H = TOTAL HEAD METRES COLUMN OF WATER																			
** FLCG 40-5T	100	0,17	1	3,6	3,3	3,1	2,7	2,3	1,8	0,8									
	114	0,20	2	3,7	3,6	3,4	3,1	2,7	2,2	1,2									
	129	0,25	3	3,9	3,8	3,6	3,4	3,0	2,6	1,5	0,3								
	143	0,33	4	4,0	3,9	3,8	3,6	3,3	2,9	1,8	0,5								
FLCG 40-7T	183	0,30	1	6,4	5,7	5,1	4,6	4,0	3,3	1,8	0,5								
	215	0,36	2	6,8	6,2	5,8	5,3	4,7	4,1	2,6	1,1								
	249	0,44	3	7,2	6,7	6,3	6,0	5,5	4,9	3,4	1,8	0,1							
	265	0,57	4	7,4	7,0	6,8	6,5	6,1	5,6	4,2	2,5	0,7							
FLCG 40-10T	468	0,78	1	7,3	7,0	6,6	6,2	5,7	5,2	4,1	3,1	2,1	1,1	0,2					
	575	0,93	2	7,9	7,7	7,4	7,0	6,7	6,3	5,3	4,3	3,3	2,2	1,2					
	666	1,06	3	8,5	8,3	8,1	7,8	7,5	7,2	6,4	5,5	4,5	3,4	2,3	1,2	0,2			
	731	1,22	4	8,9	8,8	8,6	8,4	8,1	7,8	7,2	6,4	5,5	4,5	3,4	2,2	1,0			
FLCG 50-5T	224	0,44	1	4,3	4,2	4,0	3,7	3,4	3,1	2,5	1,8	1,1	0,3						
	266	0,51	2	4,6	4,5	4,4	4,2	4,0	3,8	3,2	2,6	1,8	1,0	0,1					
	308	0,62	3	4,9	4,8	4,7	4,6	4,4	4,3	3,8	3,2	2,5	1,7	0,8					
	335	0,78	4	5,1	5,0	4,9	4,8	4,7	4,5	4,1	3,6	2,9	2,1	1,3	0,3				
FLCG 50-8T	440	0,71	1	7,0	6,9	6,6	6,4	6,0	5,7	5,0	4,3	3,6	2,9	2,2	1,5	0,7			
	514	0,83	2	7,7	7,6	7,4	7,2	7,0	6,7	6,0	5,3	4,6	3,9	3,2	2,4	1,6	0,8		
	579	0,94	3	8,3	8,3	8,2	8,0	7,8	7,5	7,0	6,4	5,7	5,0	4,2	3,5	2,6	1,7	0,8	
	626	1,07	4	8,7	8,7	8,6	8,5	8,3	8,1	7,7	7,1	6,5	5,8	5,1	4,3	3,5	2,6	1,6	
FLCG 50-10T	479	0,78	1	7,3	7,0	6,6	6,2	5,9	5,5	4,7	4,0	3,3	2,5	1,7	0,9				
	581	0,98	2	8,1	7,9	7,6	7,3	7,0	6,7	6,0	5,3	4,5	3,7	2,8	1,9	0,9			
	674	1,09	3	8,8	8,7	8,5	8,2	7,9	7,6	6,9	6,2	5,5	4,7	3,9	2,9	1,9	0,8		
	767	1,31	4	9,6	9,5	9,3	9,1	8,9	8,6	8,0	7,4	6,7	6,0	5,1	4,1	3,0	1,9	0,7	

* Electric data refer to single motor.

** Performances according to standard EN 1151-1.

Hydraulic performances in compliance with ISO 9906:2012 - Grade 3B (ex ISO 9906:1999 - Annex A)

FLCG65..T - FLCG80..T SERIES (TWIN VERSION, THREE-PHASE) HYDRAULIC PERFORMANCE TABLE (PARALLEL OPERATION)

PUMP TYPE 400V 50Hz	MAXIMUM ABSORBED POWER W*	MAXIMUM ABSORBED CURRENT A*	SPEED	Q = DELIVERY														
				l/s 0	1,4	2,8	4,2	5,6	6,9	8,3	11,1	13,9	16,7	19,4	25,0	30,6	36,1	41,7
				m ³ /h 0	5	10	15	20	25	30	40	50	60	70	90	110	130	150
H = TOTAL HEAD METRES COLUMN OF WATER																		
FLCG 65-7T	475	0,77	1	4,7	4,4	4,0	3,5	3,1	2,6	2,2	1,3							
	578	0,93	2	5,3	5,0	4,6	4,2	3,7	3,2	2,7	1,8							
	668	1,08	3	5,9	5,7	5,4	5,0	4,6	4,1	3,6	2,6	1,5	0,4					
	807	1,39	4	6,3	6,2	5,9	5,5	5,0	4,5	4,0	3,0	1,9	0,6					
FLCG 65-10T	673	1,08	1	6,3	6,2	5,7	5,1	4,5	3,9	3,4	2,4	1,3	0,2					
	803	1,29	2	7,2	7,1	6,7	6,2	5,6	5,1	4,5	3,3	2,1	0,9					
	930	1,52	3	7,8	7,7	7,4	7,0	6,5	5,9	5,3	4,1	2,9	1,6	0,2				
	1079	2,02	4	8,5	8,5	8,2	7,8	7,3	6,8	6,2	5,1	3,8	2,4	0,9				
FLCG 65-12T	863	1,42	1	7,9	7,5	7,0	6,5	5,9	5,4	4,8	3,8	2,6	1,4	0,3				
	1044	1,68	2	8,8	8,5	8,1	7,6	7,2	6,7	6,1	5,0	3,9	2,6	1,3				
	1205	1,95	3	9,4	9,2	8,9	8,5	8,0	7,6	7,1	6,0	4,8	3,6	2,2				
	1353	2,30	4	10,1	10,0	9,7	9,4	9,0	8,5	8,1	7,1	5,9	4,7	3,3				
FLCG 65-16T	1511	2,40	1	11,6	11,4	10,9	10,4	9,8	9,1	8,5	7,2	5,9	4,4	2,8				
	1760	2,80	2	12,7	12,6	12,3	11,8	11,3	10,7	10,0	8,8	7,5	6,0	4,4	0,6			
	2002	3,16	3	13,5	13,6	13,4	13,0	12,5	11,9	11,3	10,1	8,8	7,5	5,9	2,0			
	2152	3,60	4	14,4	14,5	14,3	14,0	13,6	13,1	12,5	11,4	10,1	8,8	7,3	3,5			
FLCG 80-4T	396	0,74	1	3,7	3,6	3,5	3,3	3,2	3,0	2,9	2,4	2,0	1,4	0,9				
	439	0,86	2	4,0	3,8	3,7	3,6	3,5	3,4	3,3	2,9	2,4	1,8	1,2				
	497	1,04	3	4,2	4,1	4,0	3,9	3,8	3,7	3,6	3,2	2,7	2,2	1,5				
	530	1,32	4	4,3	4,2	4,2	4,1	4,0	3,9	3,8	3,4	3,0	2,4	1,9	0,2			
FLCG 80-8T	649	1,05	1	4,2	4,1	3,9	3,6	3,4	3,1	2,9	2,4	1,9	1,3	0,6				
	774	1,26	2	5,0	4,9	4,7	4,4	4,1	3,9	3,6	3,1	2,6	1,9	1,2				
	888	1,48	3	5,7	5,6	5,4	5,1	4,8	4,5	4,2	3,6	3,1	2,5	1,7	0,4			
	1043	1,98	4	6,4	6,3	6,1	5,9	5,6	5,3	4,9	4,3	3,7	3,1	2,4	0,8			
FLCG 80-10T	839	1,34	1	5,7	5,3	5,1	4,8	4,5	4,2	3,9	3,2	2,5	1,7	0,7				
	987	1,58	2	6,7	6,3	6,0	5,7	5,4	5,2	4,8	4,1	3,3	2,4	1,4				
	1109	1,79	3	7,4	7,1	6,8	6,5	6,2	5,9	5,5	4,8	4,0	3,1	2,1				
	1259	2,12	4	8,4	8,0	7,6	7,4	7,1	6,8	6,5	5,7	4,8	3,9	2,8				
FLCG 80-12T	1380	2,15	1	8,6	8,6	8,4	8,1	7,8	7,5	7,1	6,4	5,8	5,2	4,5	2,8	1,2		
	1553	2,46	2	9,9	9,7	9,4	9,2	8,9	8,6	8,3	7,7	7,0	6,3	5,6	3,9	2,0		
	1739	2,77	3	10,8	10,5	10,3	10,0	9,7	9,5	9,2	8,6	8,0	7,3	6,5	4,8	2,8	0,8	
	1931	3,24	4	11,6	11,4	11,2	10,9	10,7	10,4	10,2	9,6	9,0	8,3	7,5	5,7	3,6	1,4	
FLCG 80-15T	1780	2,84	1	10,2	9,8	9,5	9,2	8,9	8,6	8,3	7,6	6,8	6,0	5,2	3,5	1,5		
	2117	3,36	2	11,5	11,2	10,9	10,7	10,4	10,1	9,8	9,2	8,5	7,7	6,9	5,1	3,1	0,9	
	2463	3,89	3	12,7	12,4	12,2	11,9	11,7	11,4	11,2	10,6	9,9	9,2	8,5	6,7	4,6	2,3	
	2735	4,92	4	13,9	13,7	13,4	13,2	13,0	12,8	12,5	12,0	11,5	10,8	10,1	8,4	6,3	3,9	1,3

* Electric data refer to single motor.

flcgt-2-2p50P-en_c_th

Hydraulic performances in compliance with ISO 9906:2012 - Grade 3B (ex ISO 9906:1999 - Annex A)

**FLC SERIES
SINGLE-PHASE OPERATING CHARACTERISTICS**

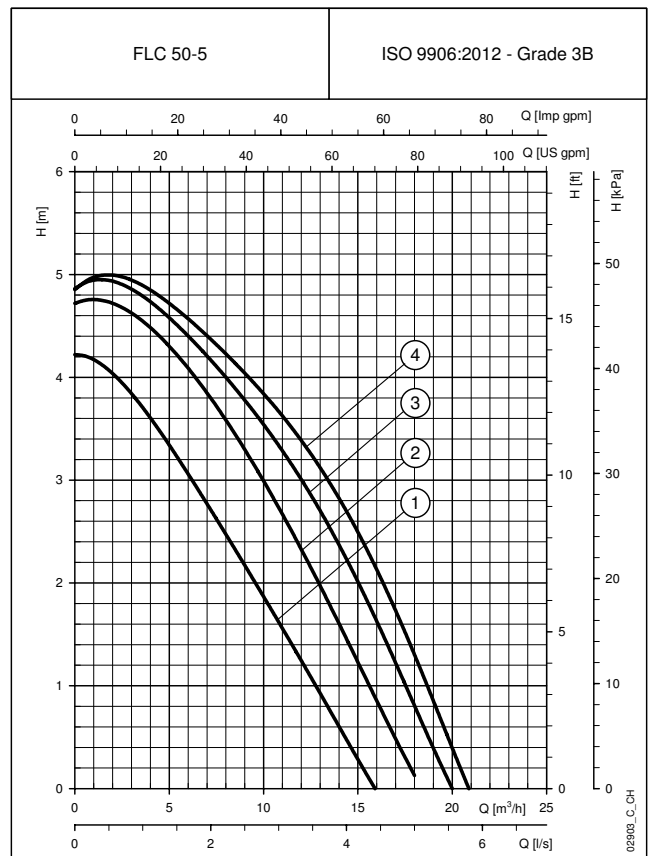
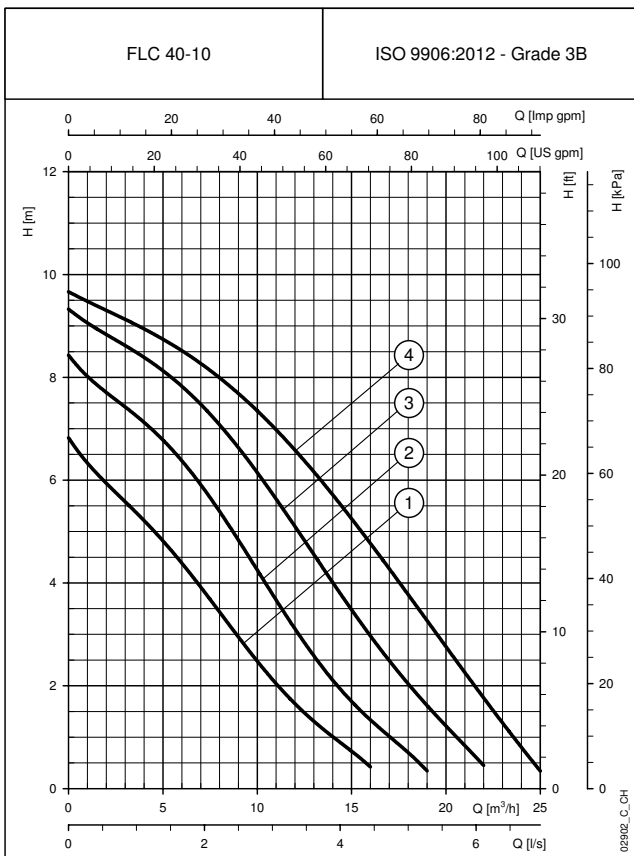
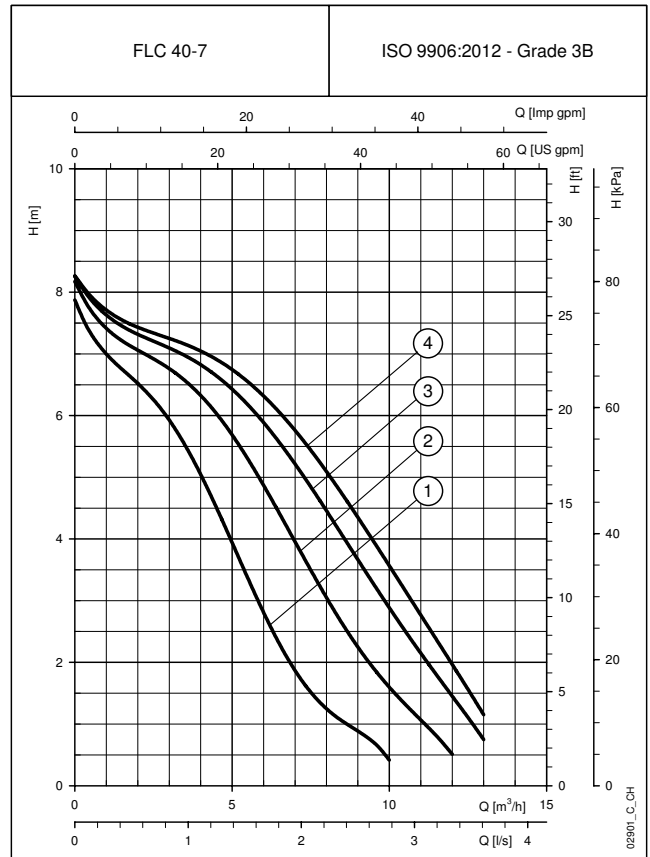
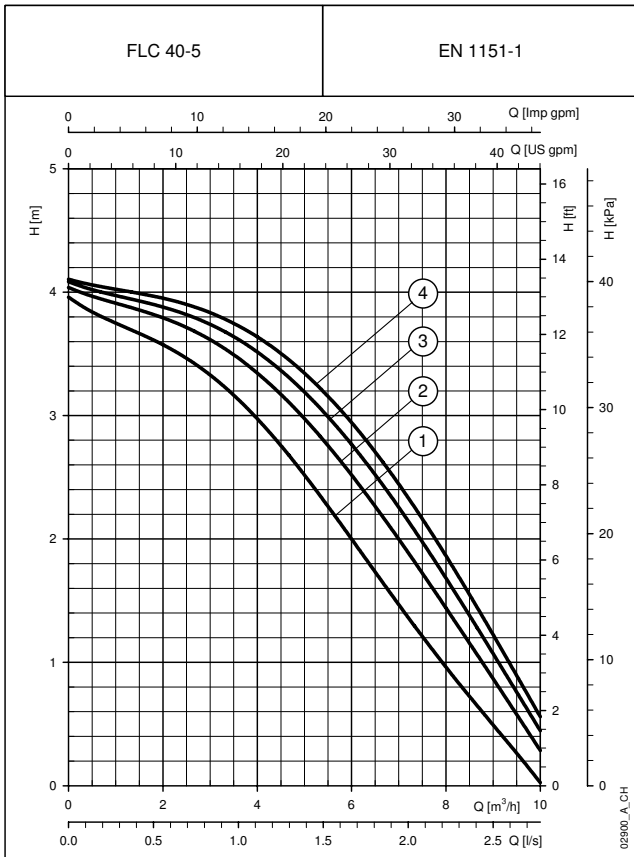

These performances are valid for liquids with density $\rho = 1.0 \text{ Kg/dm}^3$ and kinematic viscosity $\nu = 1 \text{ mm}^2/\text{sec}$.

**FLC SERIES
SINGLE-PHASE OPERATING CHARACTERISTICS**

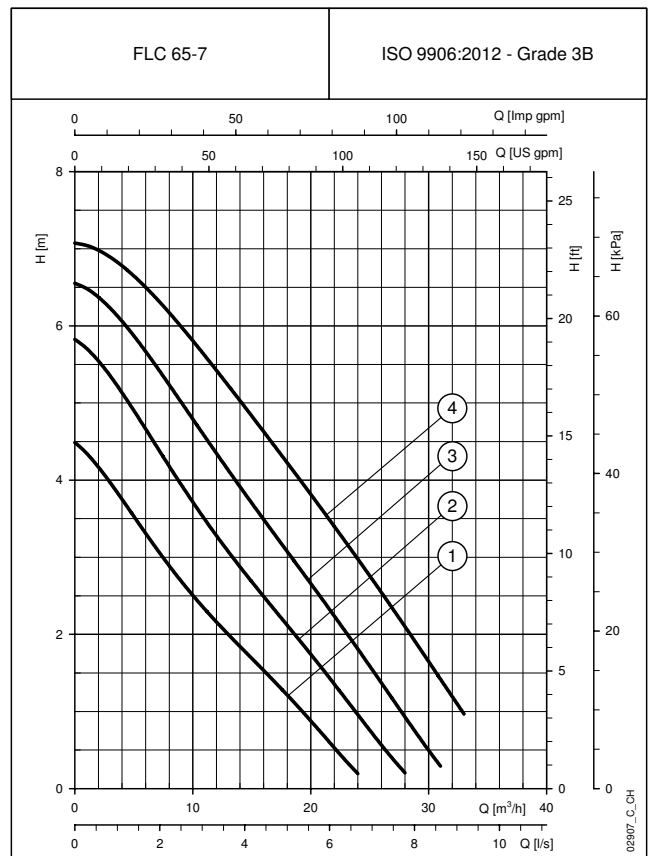
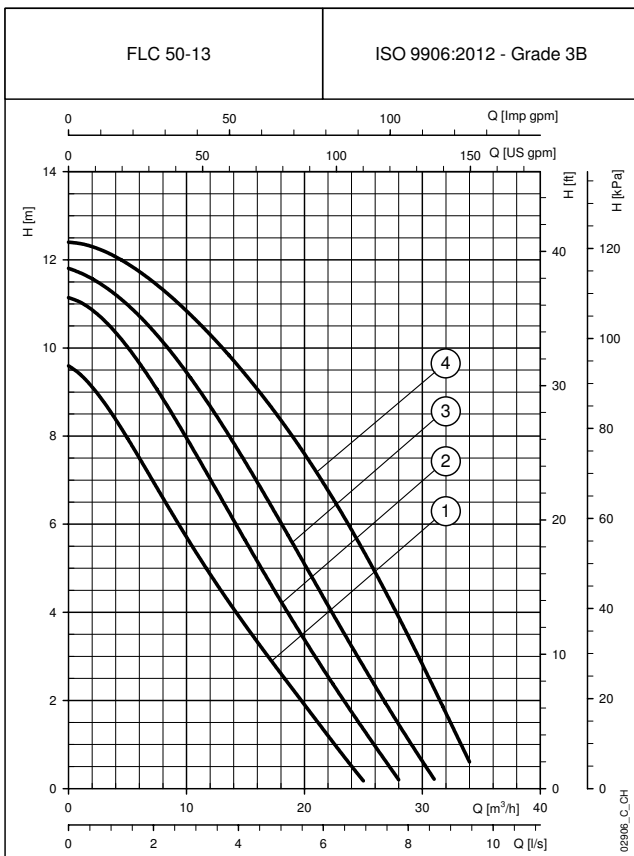
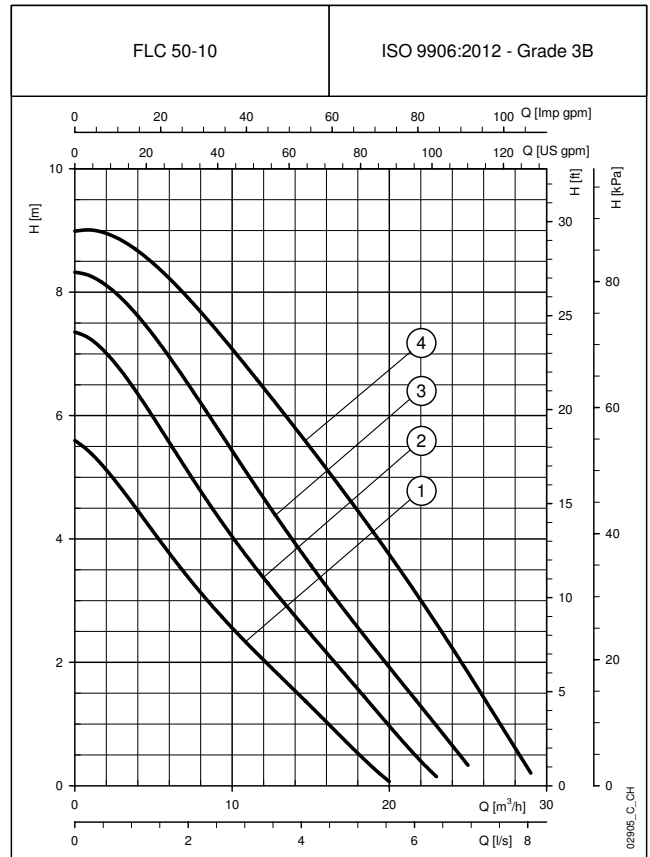
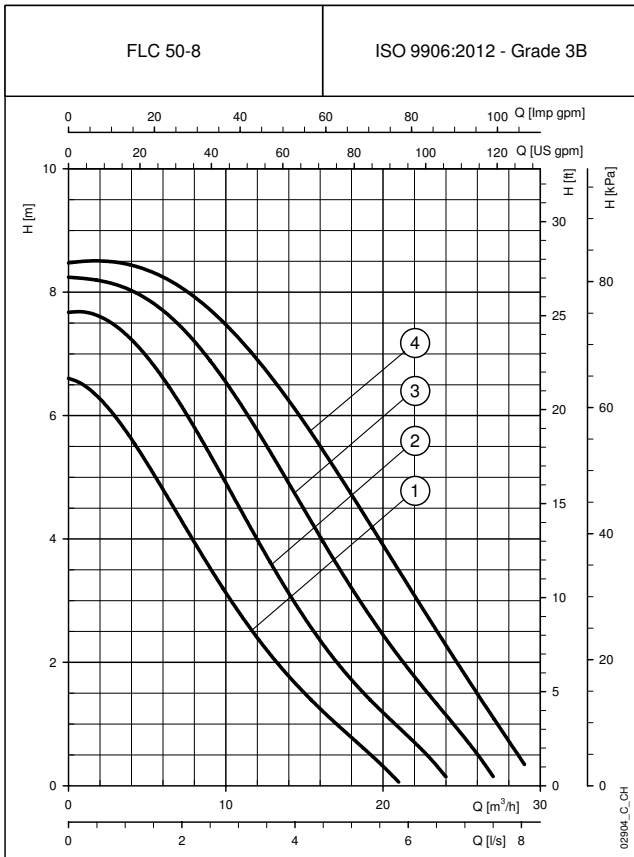

These performances are valid for liquids with density $\rho = 1.0 \text{ Kg/dm}^3$ and kinematic viscosity $\nu = 1 \text{ mm}^2/\text{sec}$.

FLC SERIES SINGLE-PHASE OPERATING CHARACTERISTICS

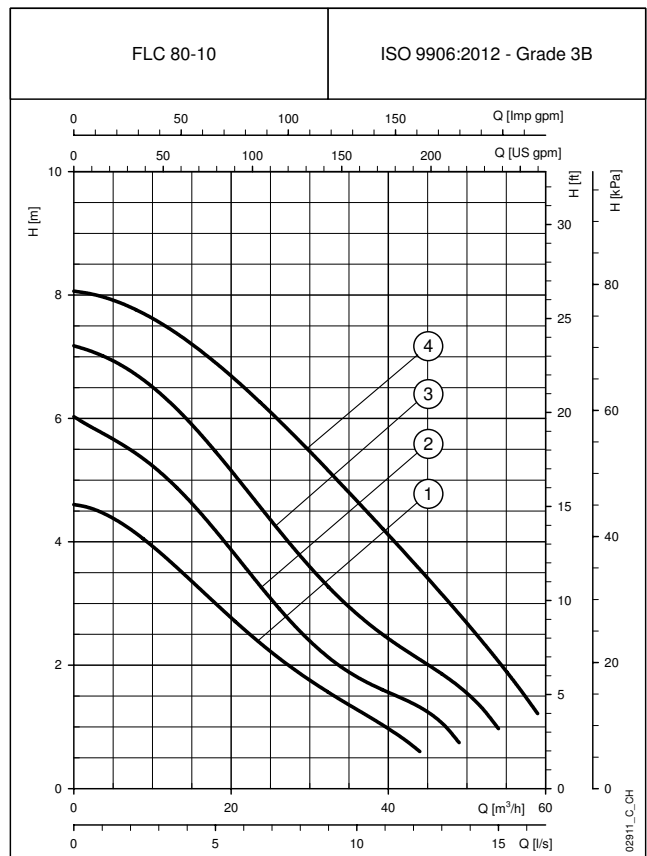
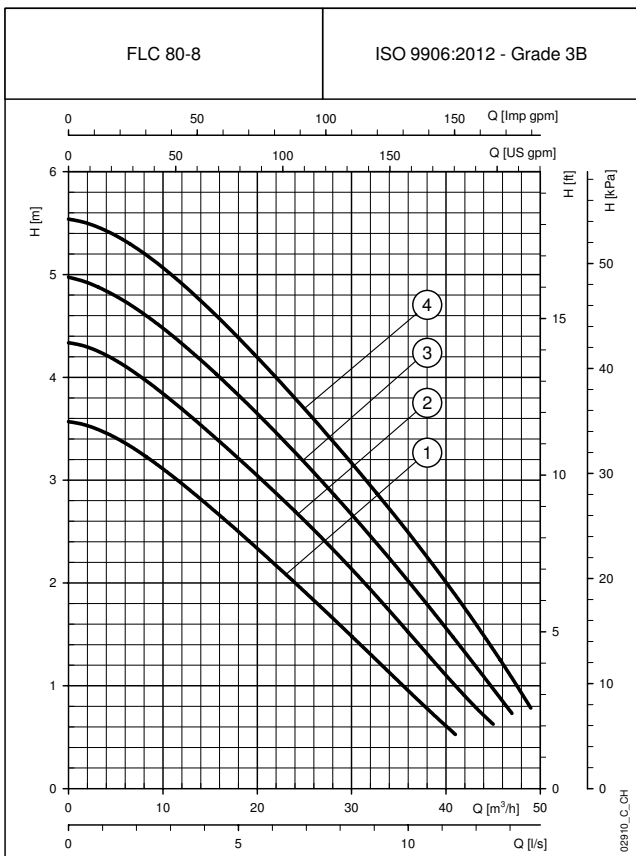
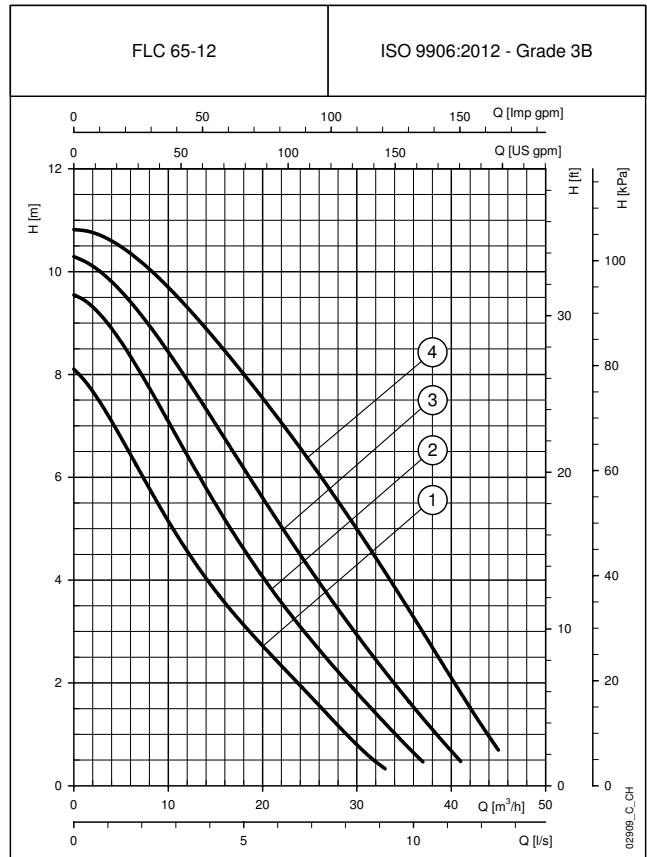
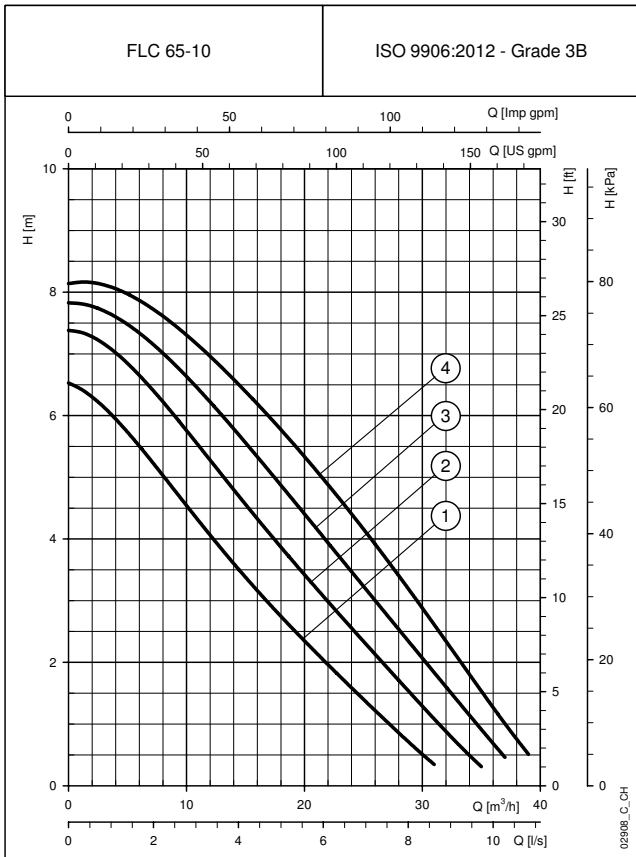

These performances are valid for liquids with density $\rho = 1.0 \text{ Kg/dm}^3$ and kinematic viscosity $\nu = 1 \text{ mm}^2/\text{sec}$.

**FLC..T SERIES
THREE-PHASE OPERATING CHARACTERISTICS**

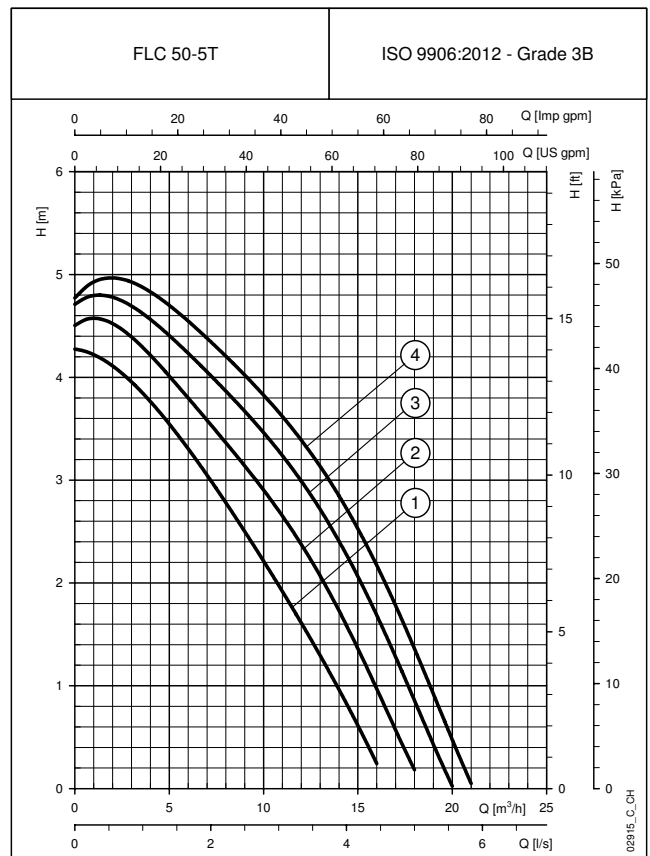
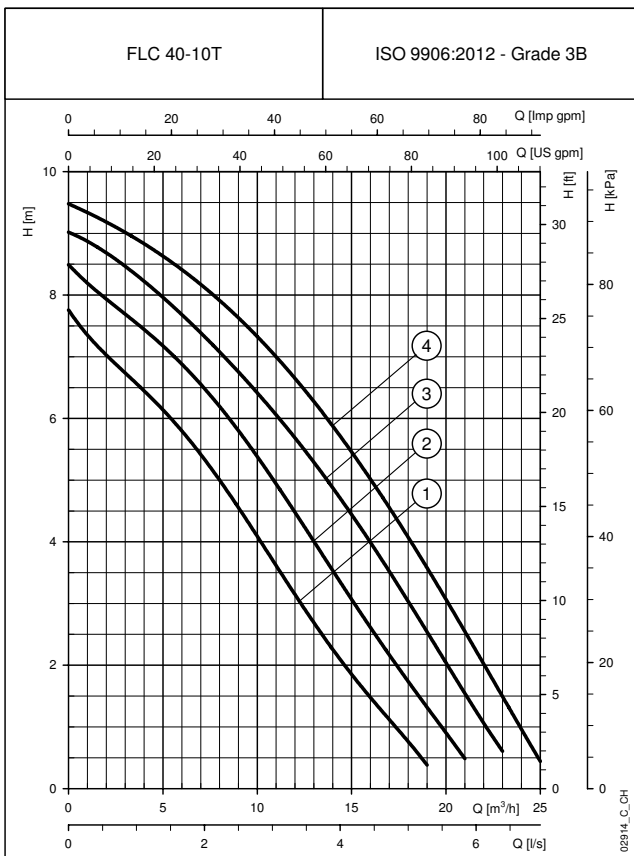
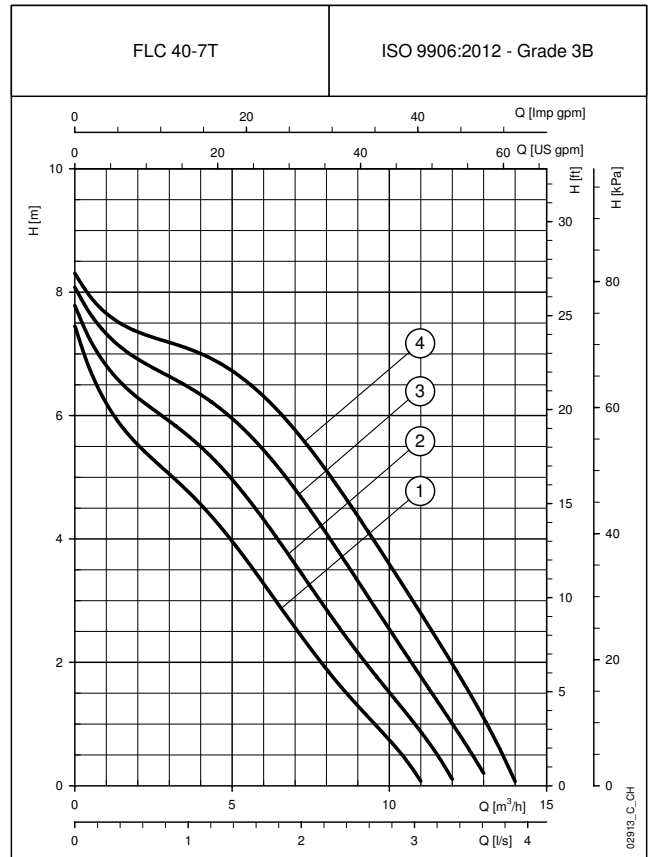
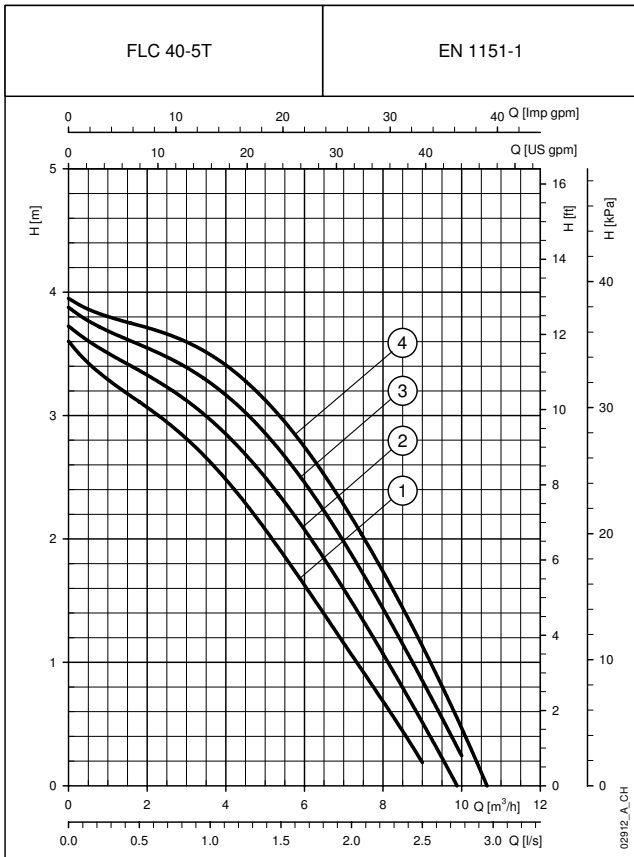

These performances are valid for liquids with density $\rho = 1.0 \text{ Kg/dm}^3$ and kinematic viscosity $\nu = 1 \text{ mm}^2/\text{sec}$.

FLC..T SERIES THREE-PHASE OPERATING CHARACTERISTICS

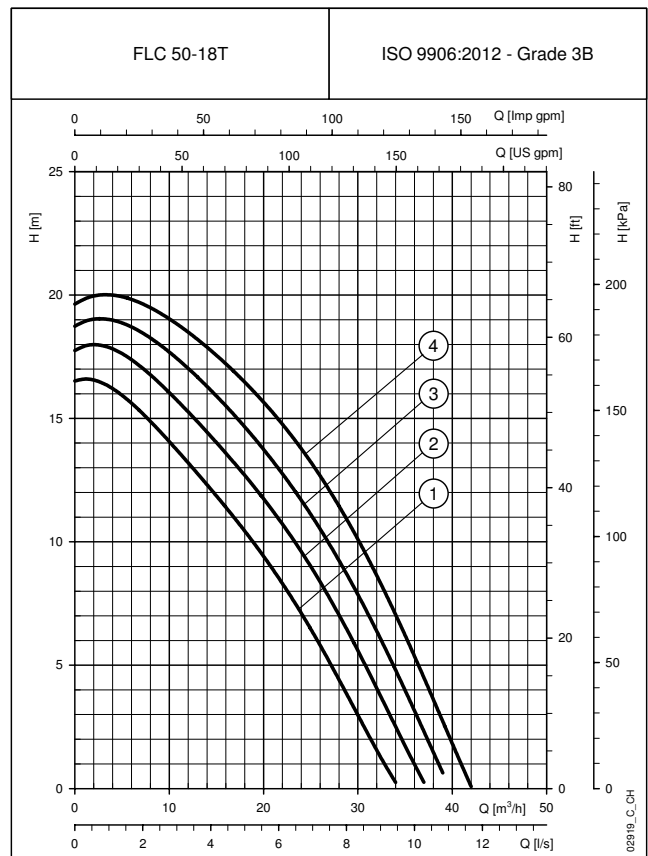
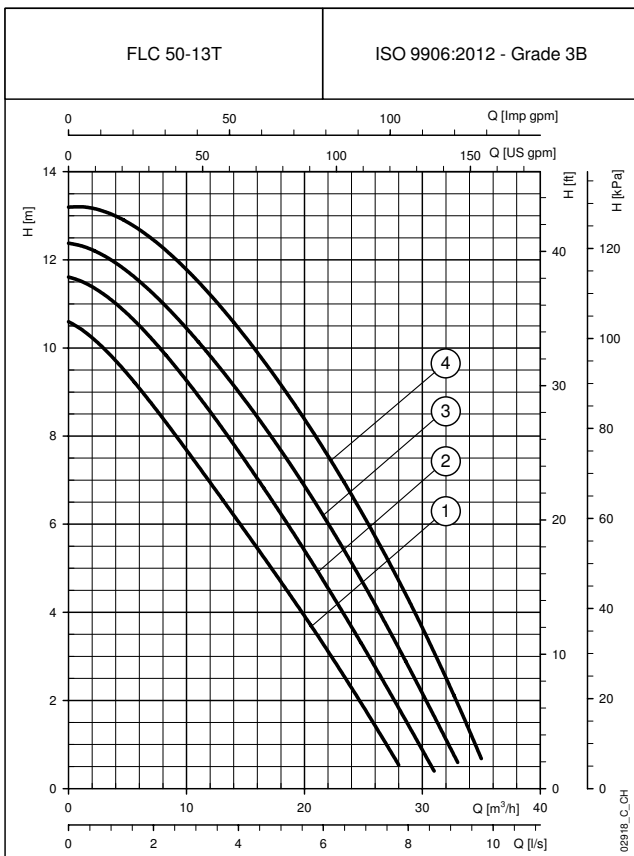
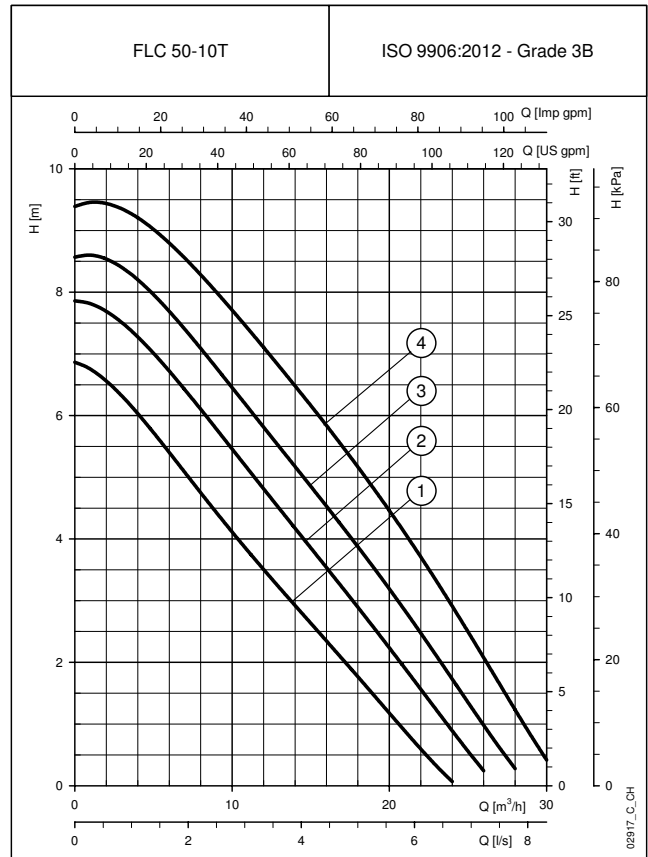
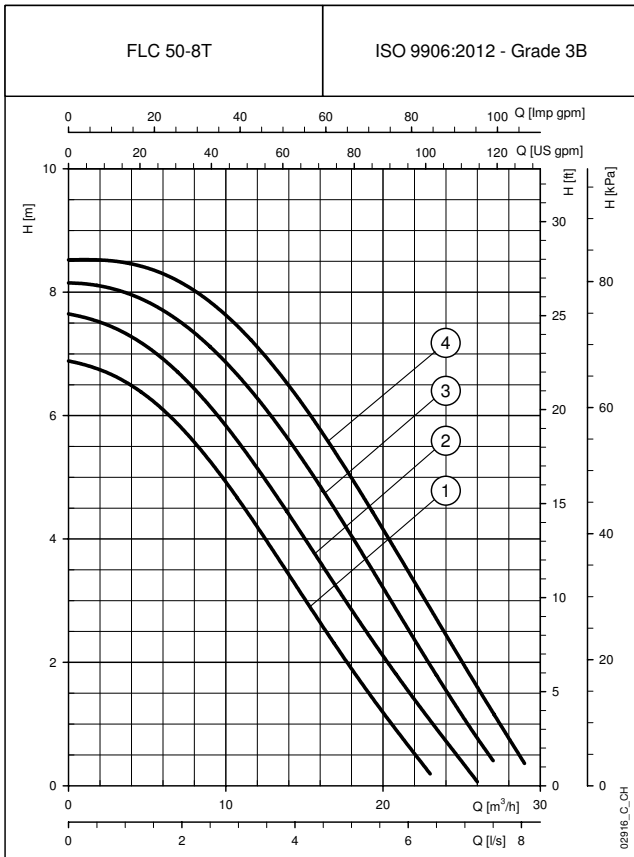

These performances are valid for liquids with density $\rho = 1.0 \text{ Kg/dm}^3$ and kinematic viscosity $\nu = 1 \text{ mm}^2/\text{sec}$.

**FLC..T SERIES
THREE-PHASE OPERATING CHARACTERISTICS**

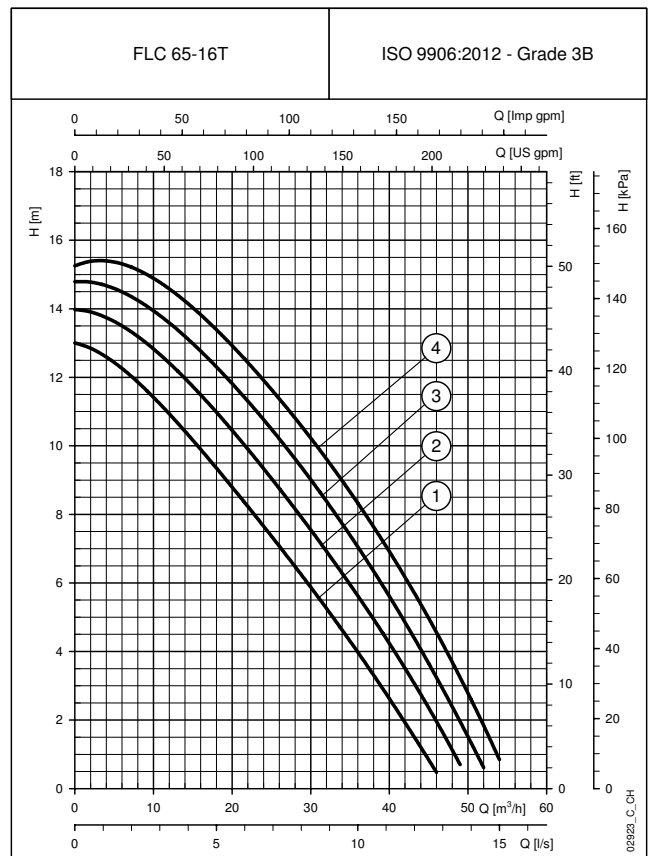
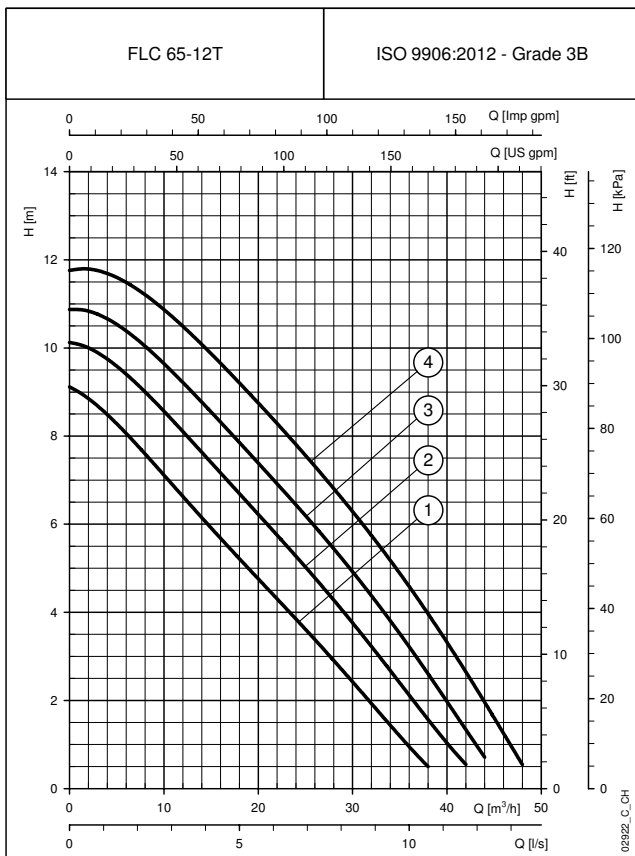
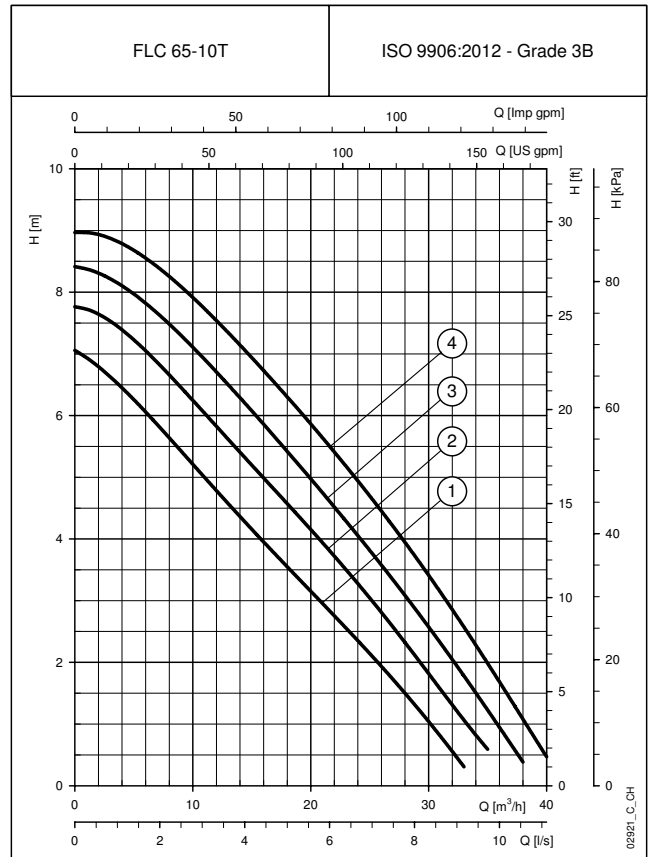
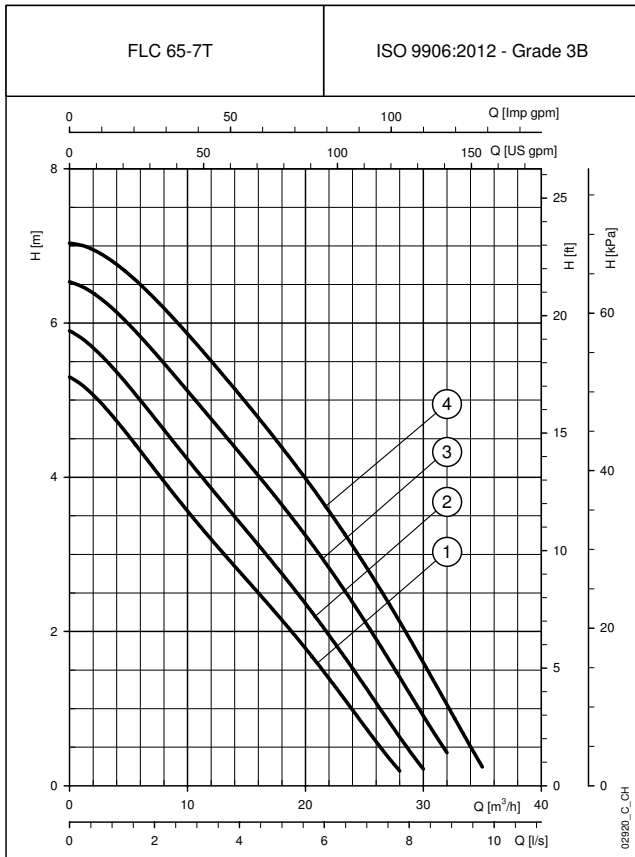

These performances are valid for liquids with density $\rho = 1.0 \text{ Kg/dm}^3$ and kinematic viscosity $\nu = 1 \text{ mm}^2/\text{sec}$.

**FLC..T SERIES
THREE-PHASE OPERATING CHARACTERISTICS**

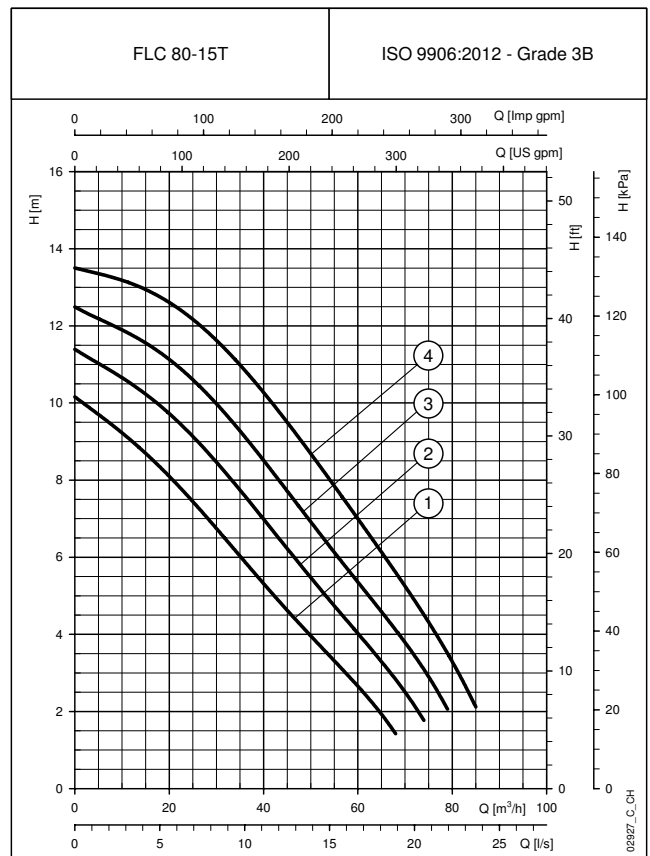
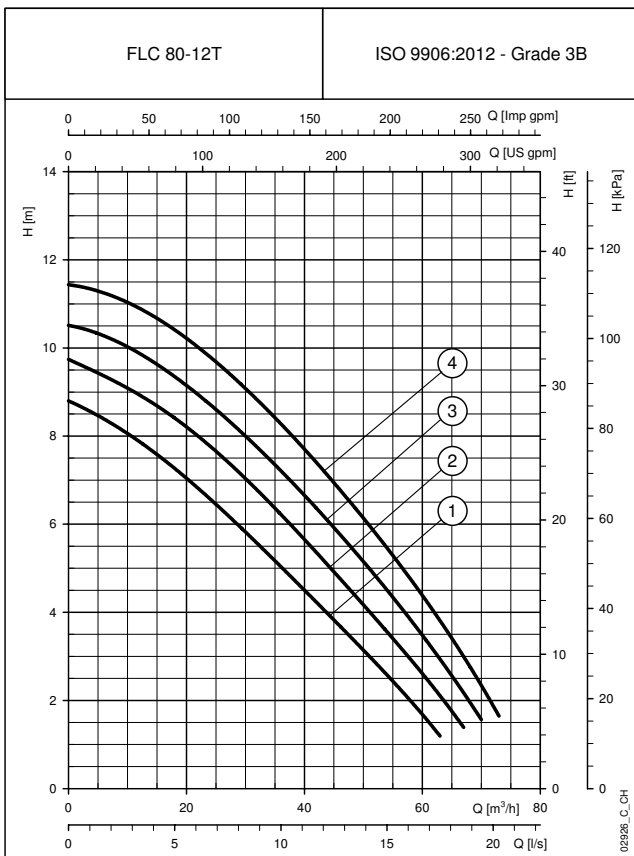
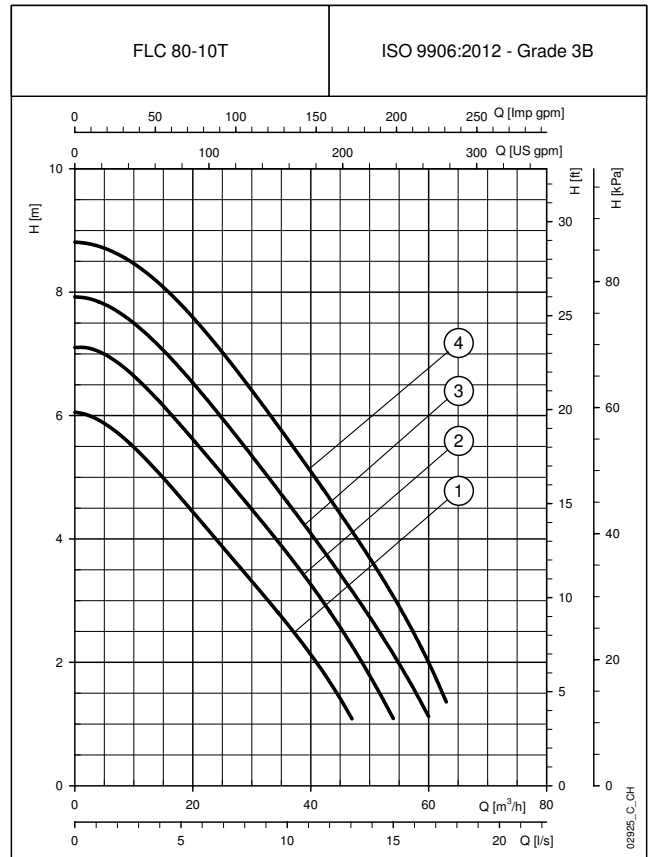
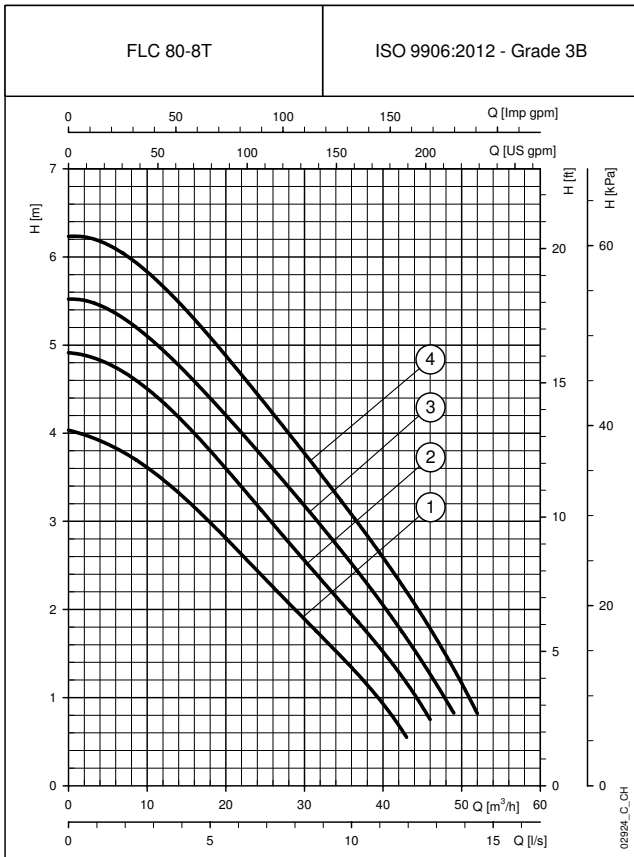

These performances are valid for liquids with density $\rho = 1.0 \text{ Kg/dm}^3$ and kinematic viscosity $\nu = 1 \text{ mm}^2/\text{sec}$.

**FLCG SERIES
SINGLE-PHASE OPERATING CHARACTERISTICS**

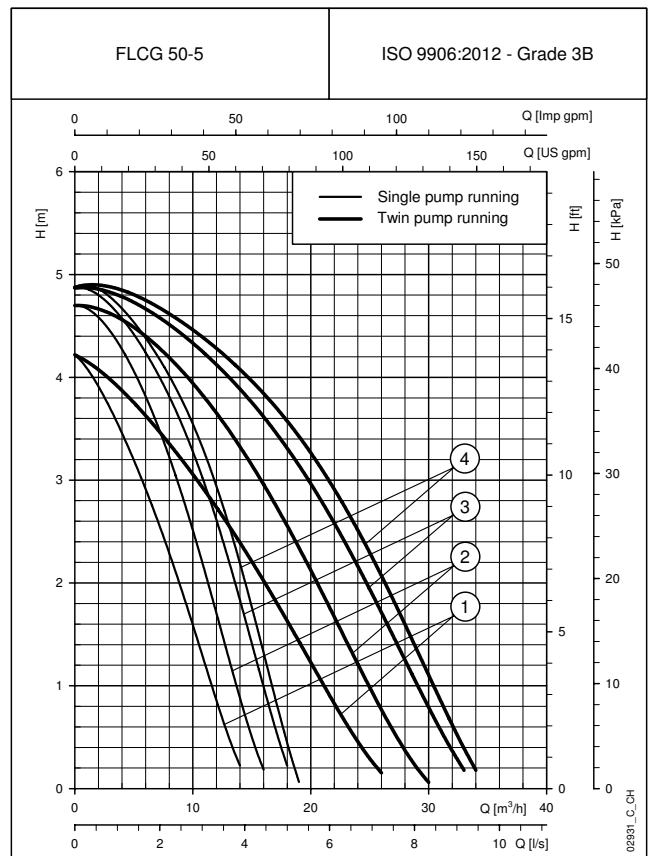
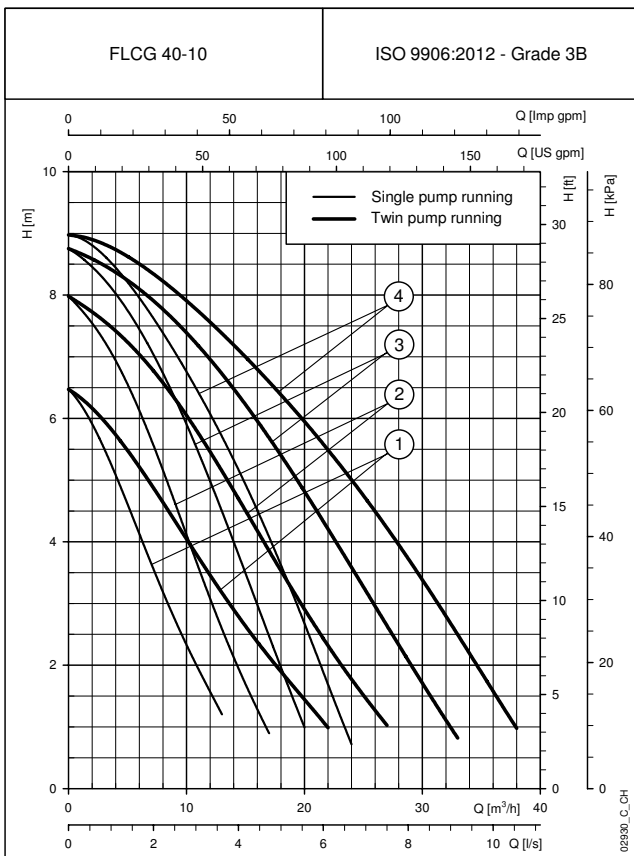
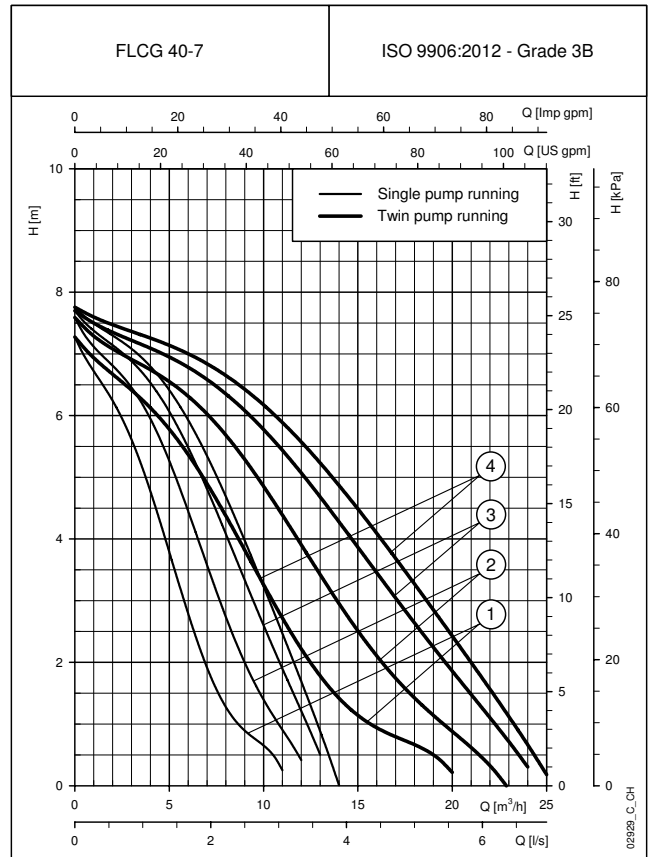
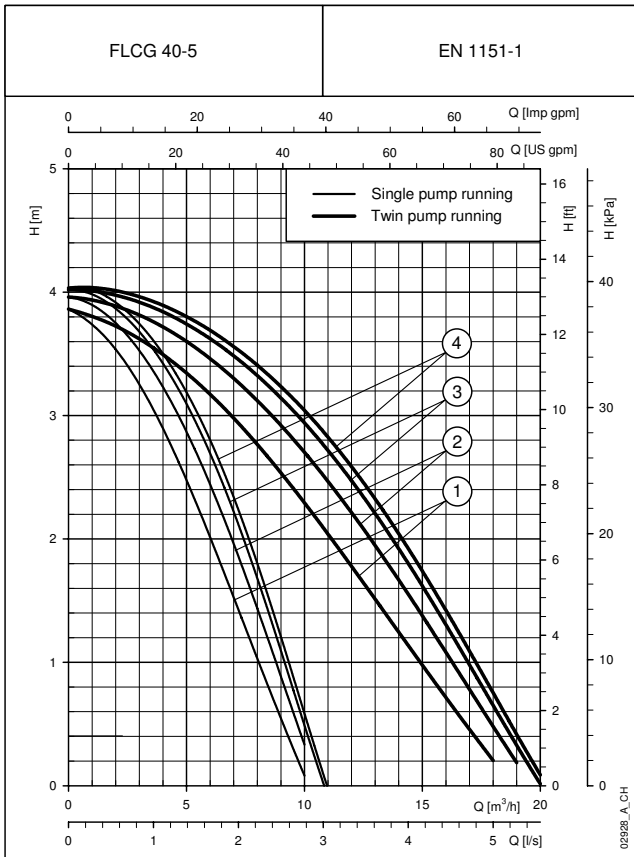

These performances are valid for liquids with density $\rho = 1.0 \text{ Kg/dm}^3$ and kinematic viscosity $\nu = 1 \text{ mm}^2/\text{sec}$.

FLCG SERIES SINGLE-PHASE OPERATING CHARACTERISTICS

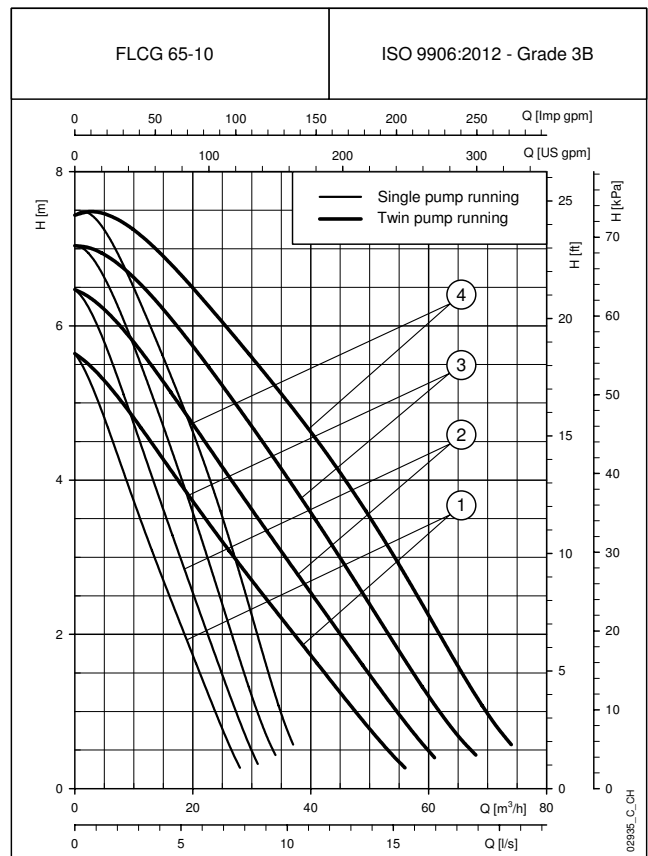
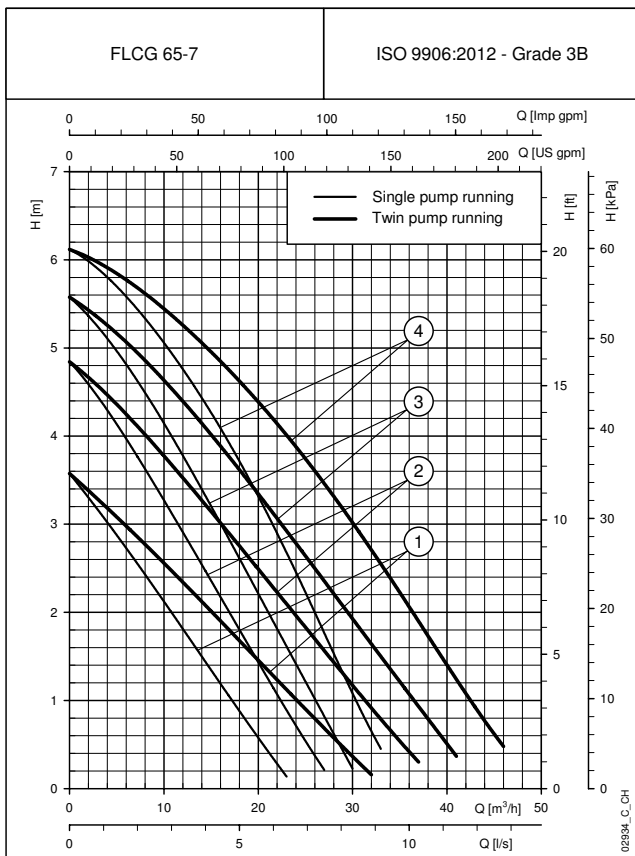
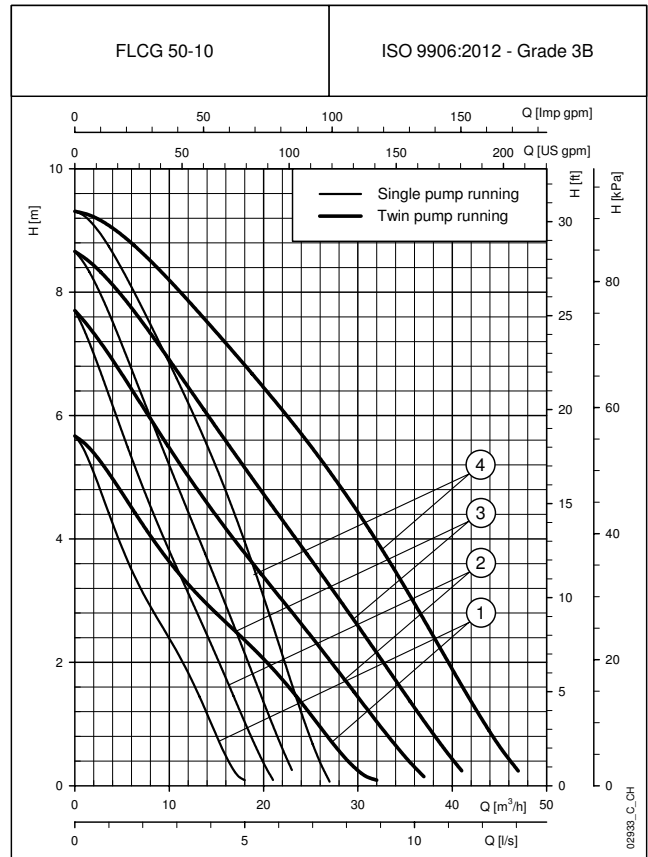
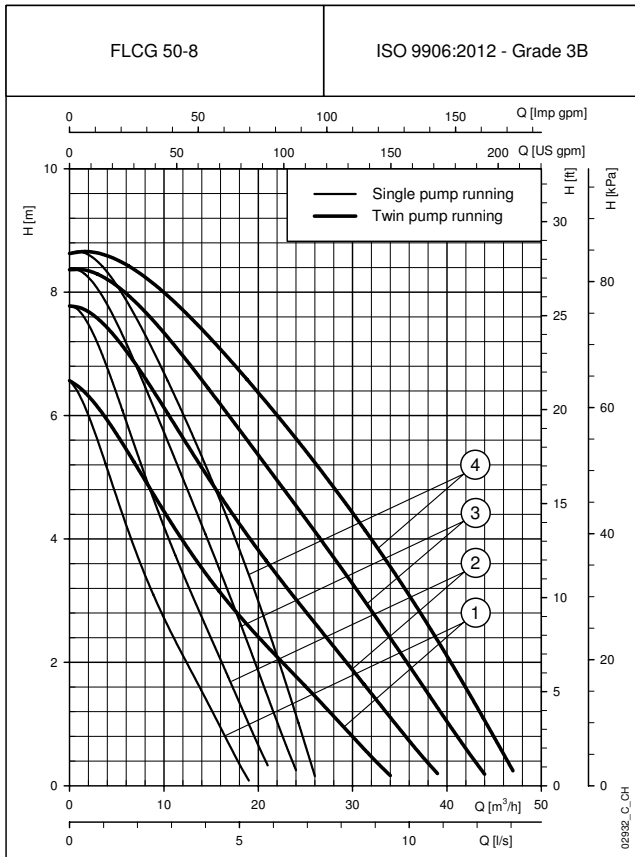

These performances are valid for liquids with density $\rho = 1.0 \text{ Kg/dm}^3$ and kinematic viscosity $\nu = 1 \text{ mm}^2/\text{sec}$.

FLCG SERIES SINGLE-PHASE OPERATING CHARACTERISTICS

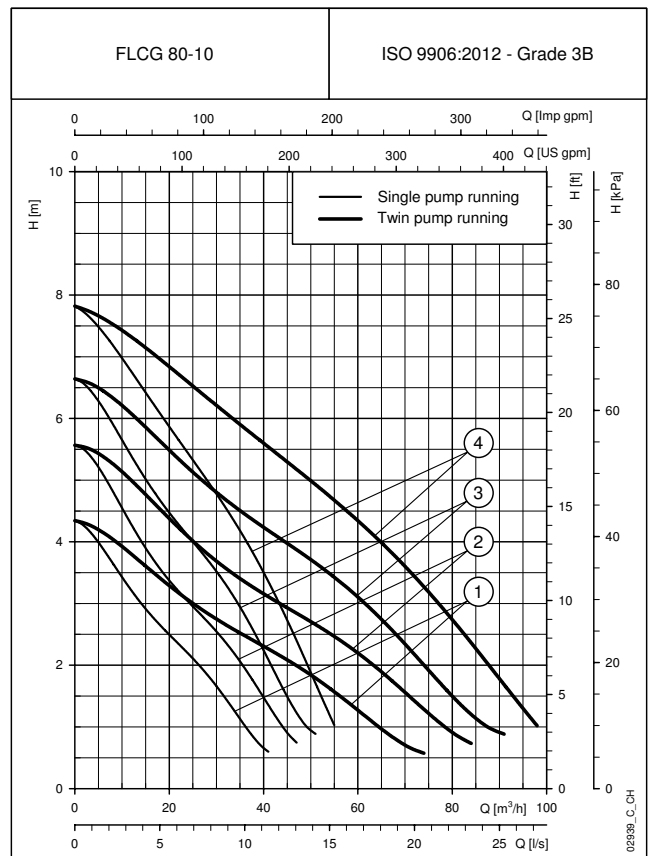
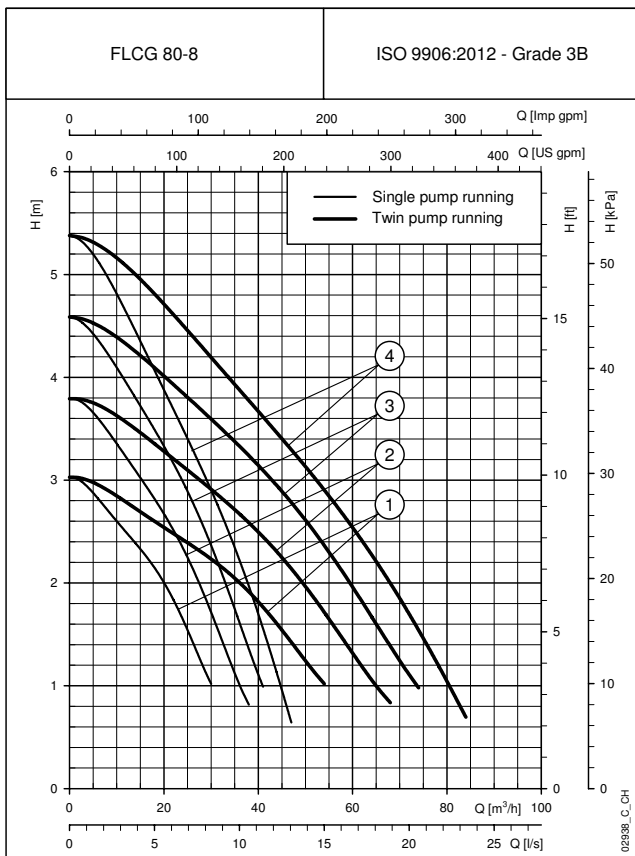
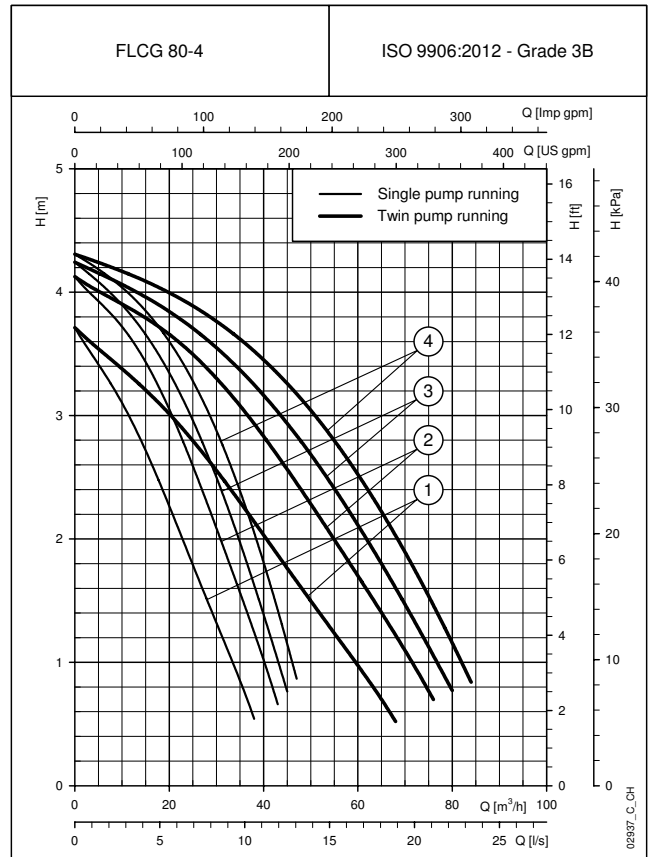
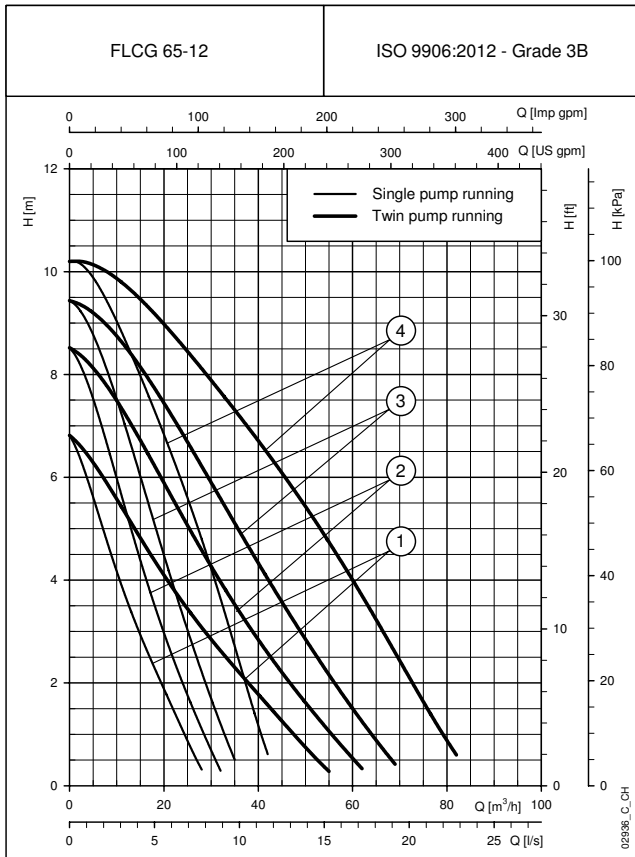

These performances are valid for liquids with density $\rho = 1.0 \text{ Kg/dm}^3$ and kinematic viscosity $\nu = 1 \text{ mm}^2/\text{sec}$.

**FLCG..T SERIES
THREE-PHASE OPERATING CHARACTERISTICS**

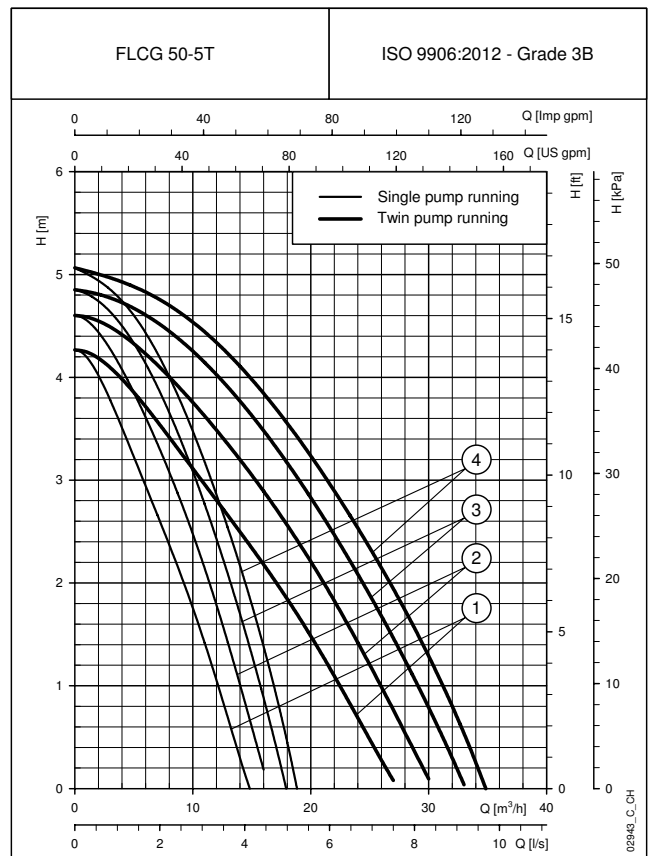
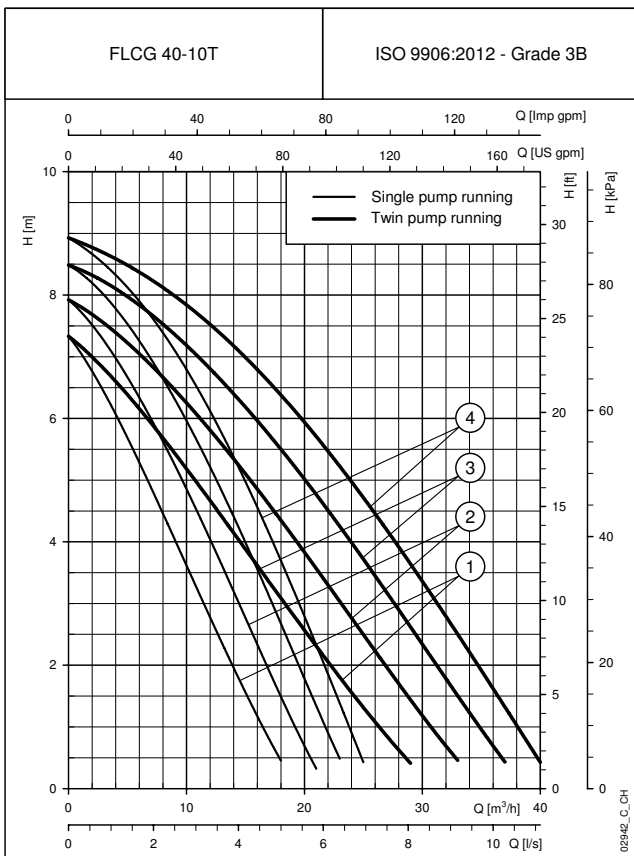
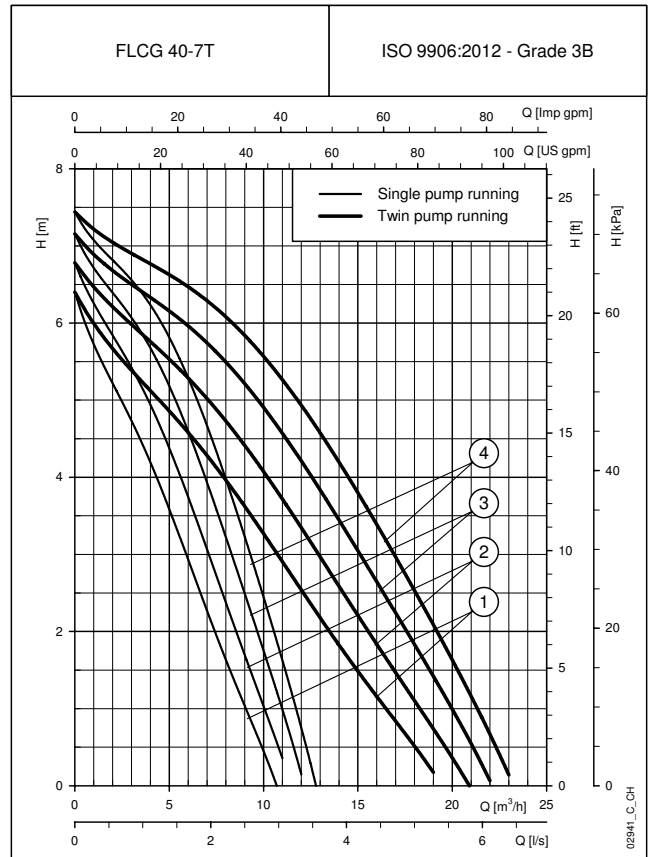
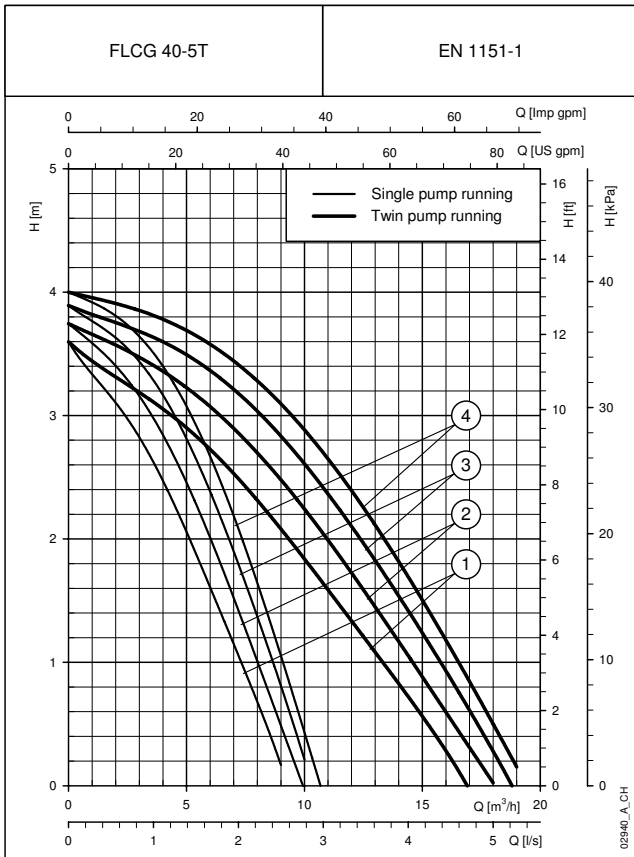

These performances are valid for liquids with density $\rho = 1.0 \text{ Kg/dm}^3$ and kinematic viscosity $\nu = 1 \text{ mm}^2/\text{sec}$.

**FLCG..T SERIES
THREE-PHASE OPERATING CHARACTERISTICS**

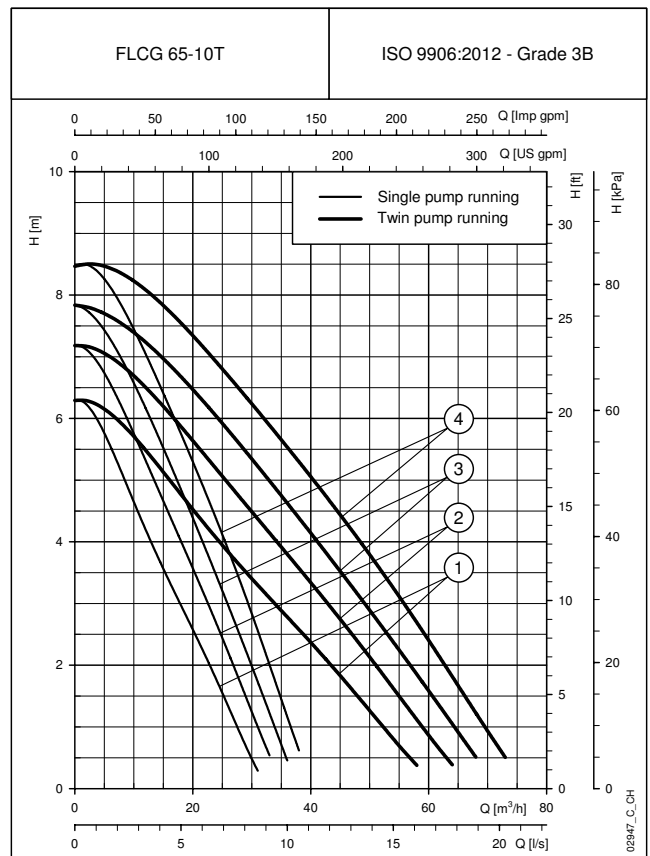
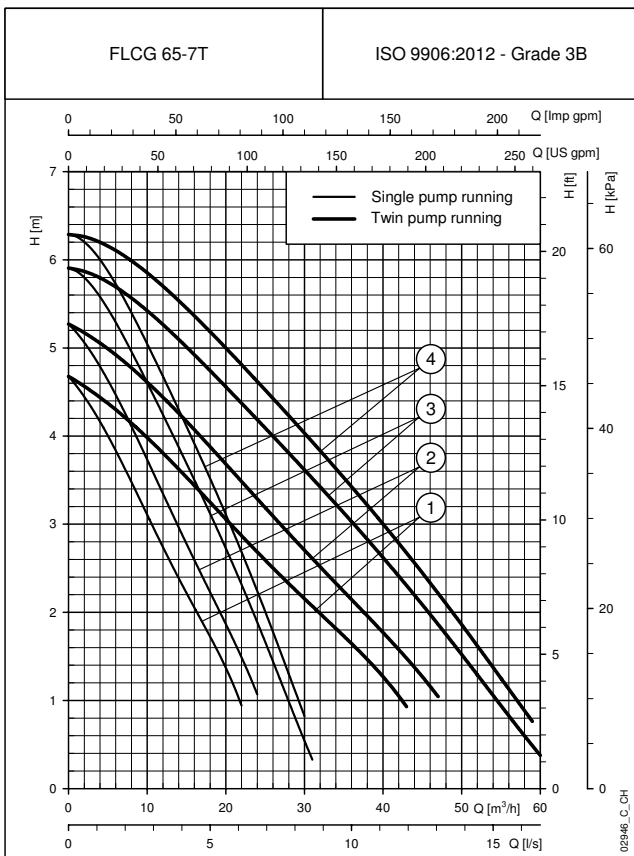
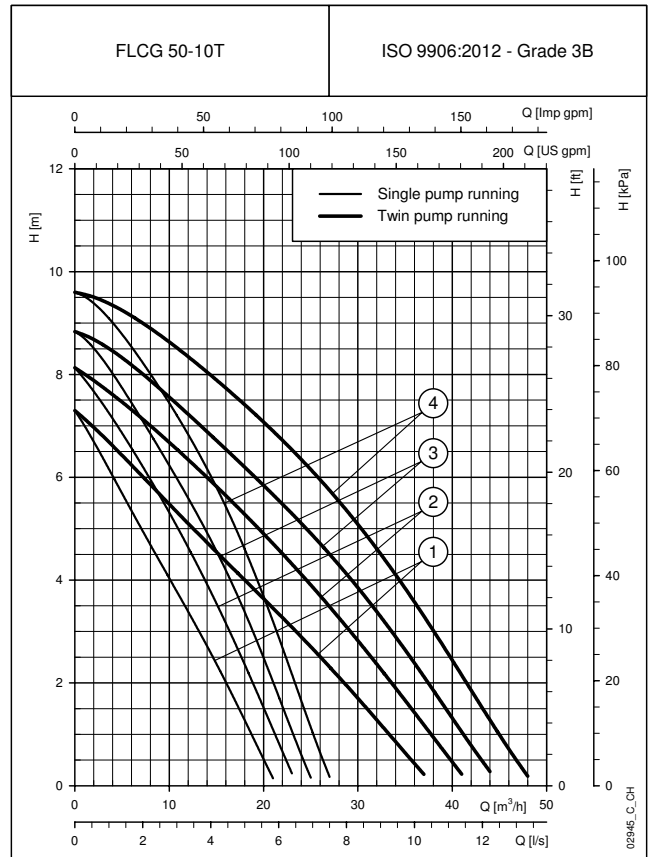
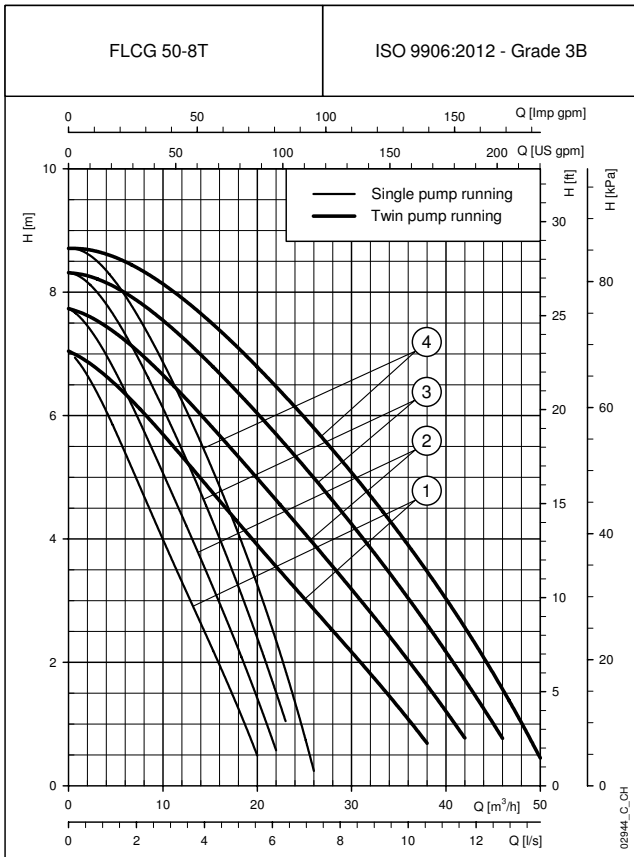

These performances are valid for liquids with density $\rho = 1.0 \text{ Kg/dm}^3$ and kinematic viscosity $\nu = 1 \text{ mm}^2/\text{sec}$.

**FLCG..T SERIES
THREE-PHASE OPERATING CHARACTERISTICS**

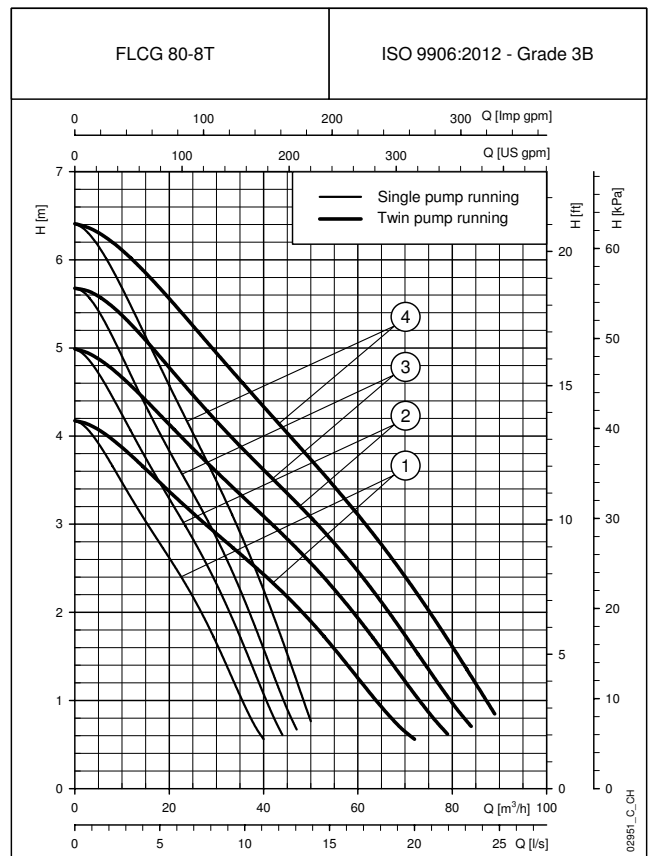
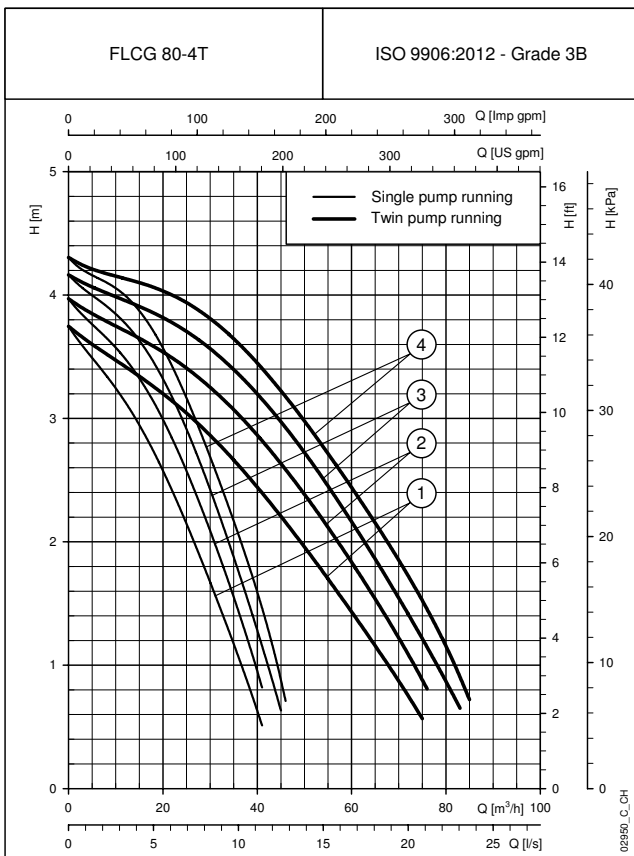
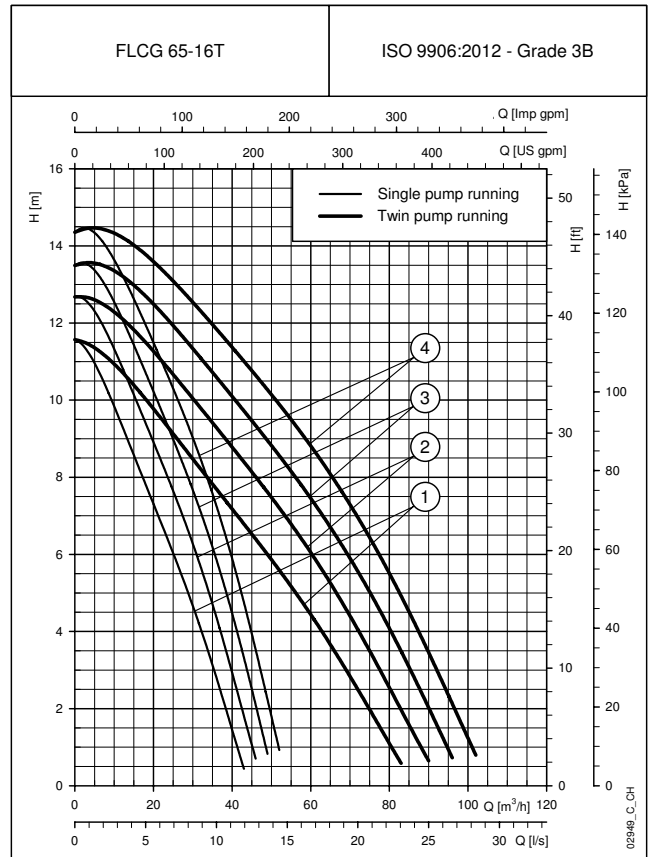
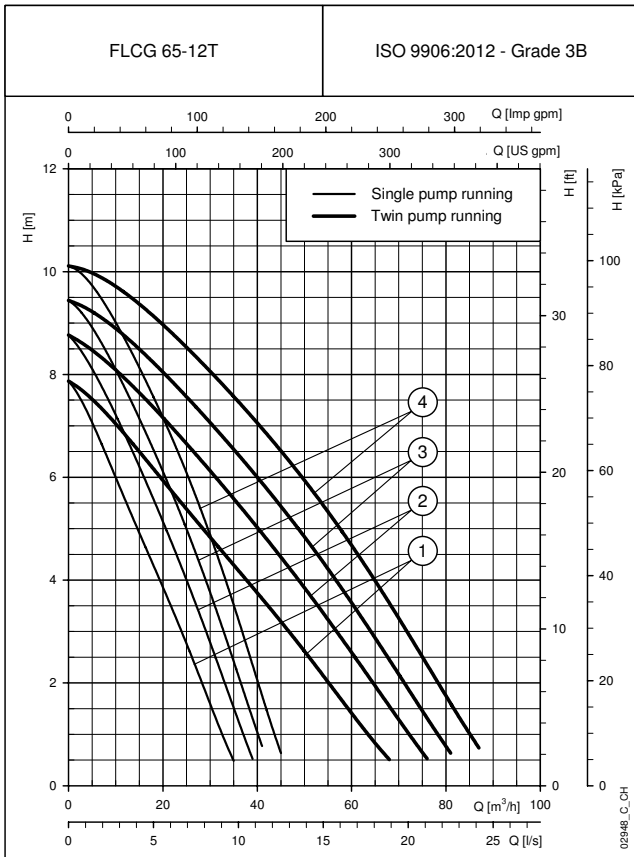

These performances are valid for liquids with density $\rho = 1.0 \text{ Kg/dm}^3$ and kinematic viscosity $\nu = 1 \text{ mm}^2/\text{sec}$.

**FLCG..T SERIES
THREE-PHASE OPERATING CHARACTERISTICS**

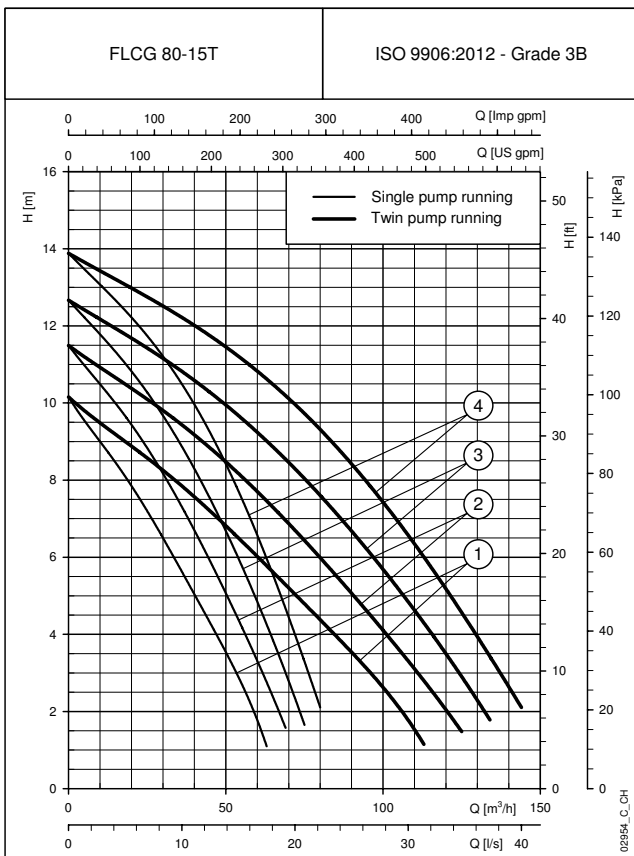
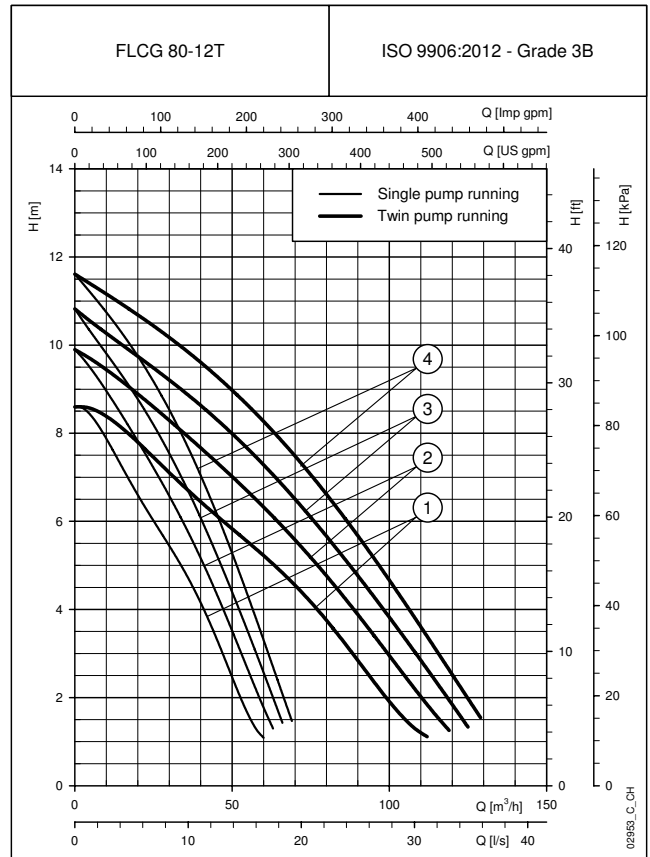
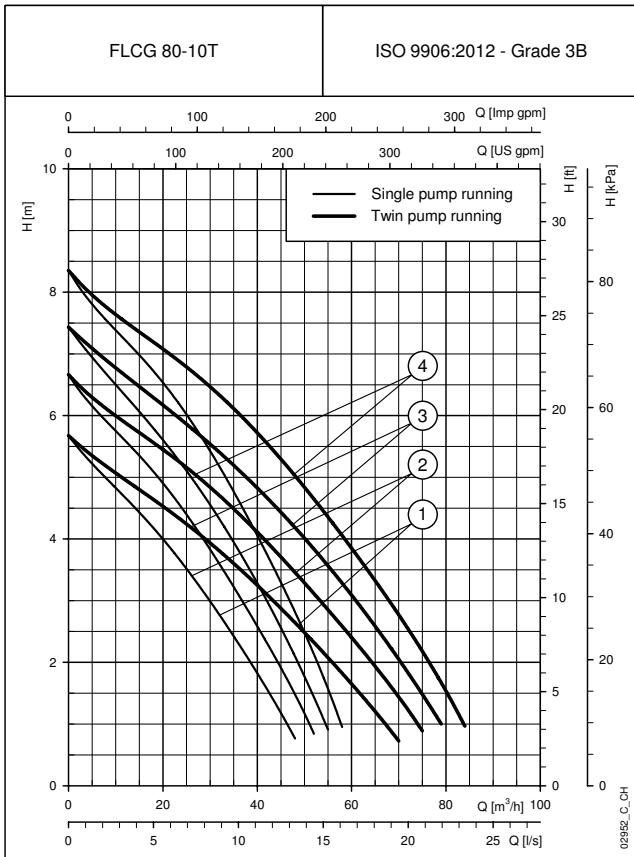

These performances are valid for liquids with density $\rho = 1.0 \text{ Kg/dm}^3$ and kinematic viscosity $\nu = 1 \text{ mm}^2/\text{sec}$.

FLC SERIES DIMENSIONS AND WEIGHTS

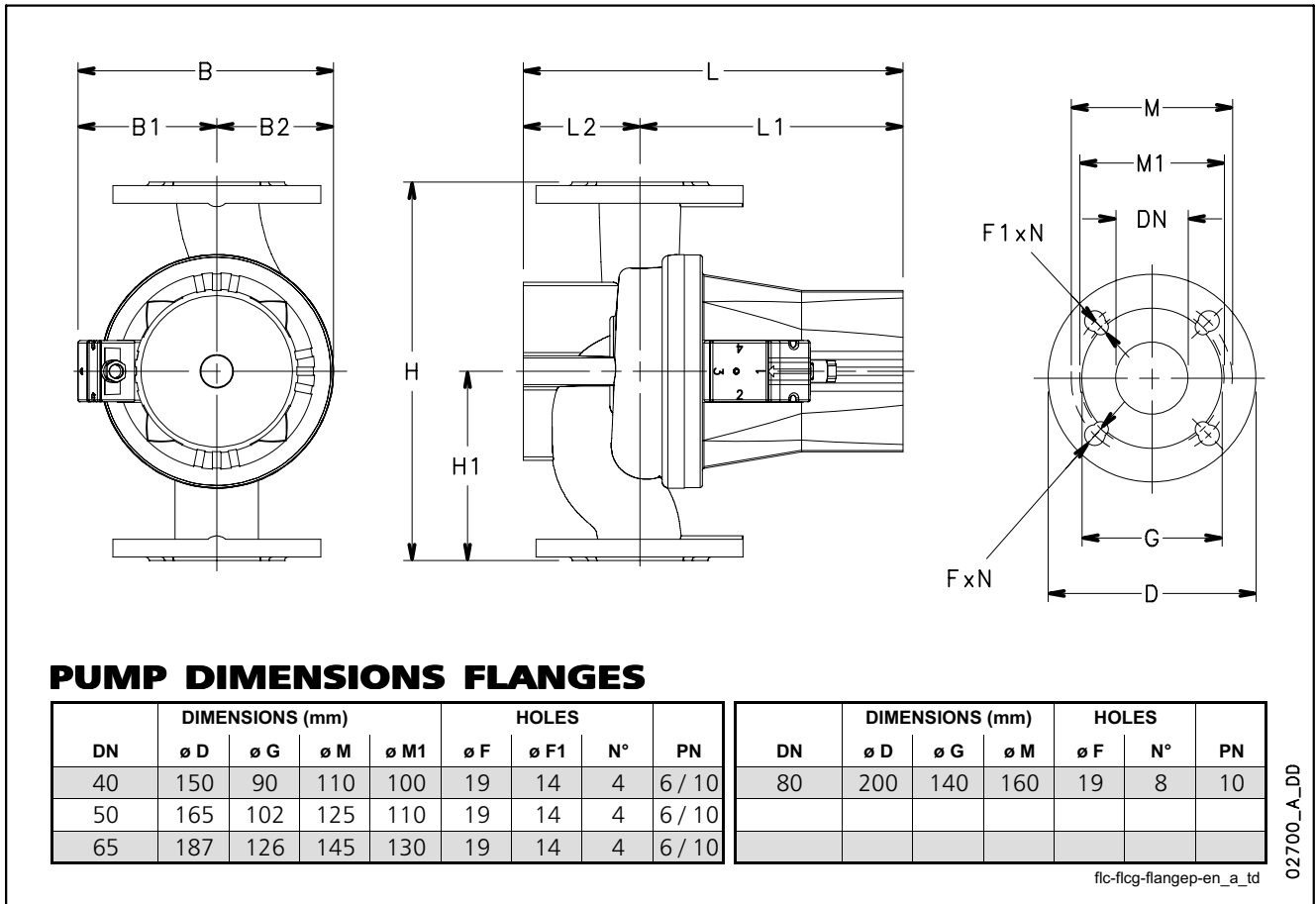

DIMENSIONS AND WEIGHTS TABLE

PUMP TYPE		DIMENSIONS (mm)									WEIGHT	
SINGLE-PHASE	THREE-PHASE	B	B1	B2	H	H1	L	L1	L2	DN	kg	
FLC 40-5	FLC 40-5T	180	105	75	250	125	236	166	70	40	11	
FLC 40-7	FLC 40-7T	180	105	75	250	125	245	175	70	40	11	
FLC 40-10	FLC 40-10T	168	93	75	250	125	276	201	75	40	14	
FLC 50-5	FLC 50-5T	173	83	90	280	140	279	194	85	50	18	
FLC 50-8	FLC 50-8T	173	83	90	280	140	279	194	85	50	18	
FLC 50-10	FLC 50-10T	200	110	90	280	140	312	232	80	50	22	
FLC 50-13	FLC 50-13T	200	110	90	280	140	312	232	80	50	25	
-	FLC 50-18T	230	110	120	280	140	360	275	82	50	29	
FLC 65-7	FLC 65-7T	225	125	100	340	170	345	255	90	65	29	
FLC 65-10	FLC 65-10T	225	125	100	340	170	345	255	90	65	28	
FLC 65-12	FLC 65-12T	225	125	100	340	170	345	255	90	65	30	
-	FLC 65-16T	195	95	100	340	170	394	304	90	65	35	
FLC 80-8	FLC 80-8T	310	135	175	360	180	346	241	105	80	34	
FLC 80-10	FLC 80-10T	310	135	175	360	180	346	241	105	80	36	
-	FLC 80-12T	310	135	175	360	180	351	246	105	80	40	
-	FLC 80-15T	310	135	175	360	180	351	246	105	80	41	

flc-2p50-en_a_td

FLCG SERIES DIMENSIONS AND WEIGHTS

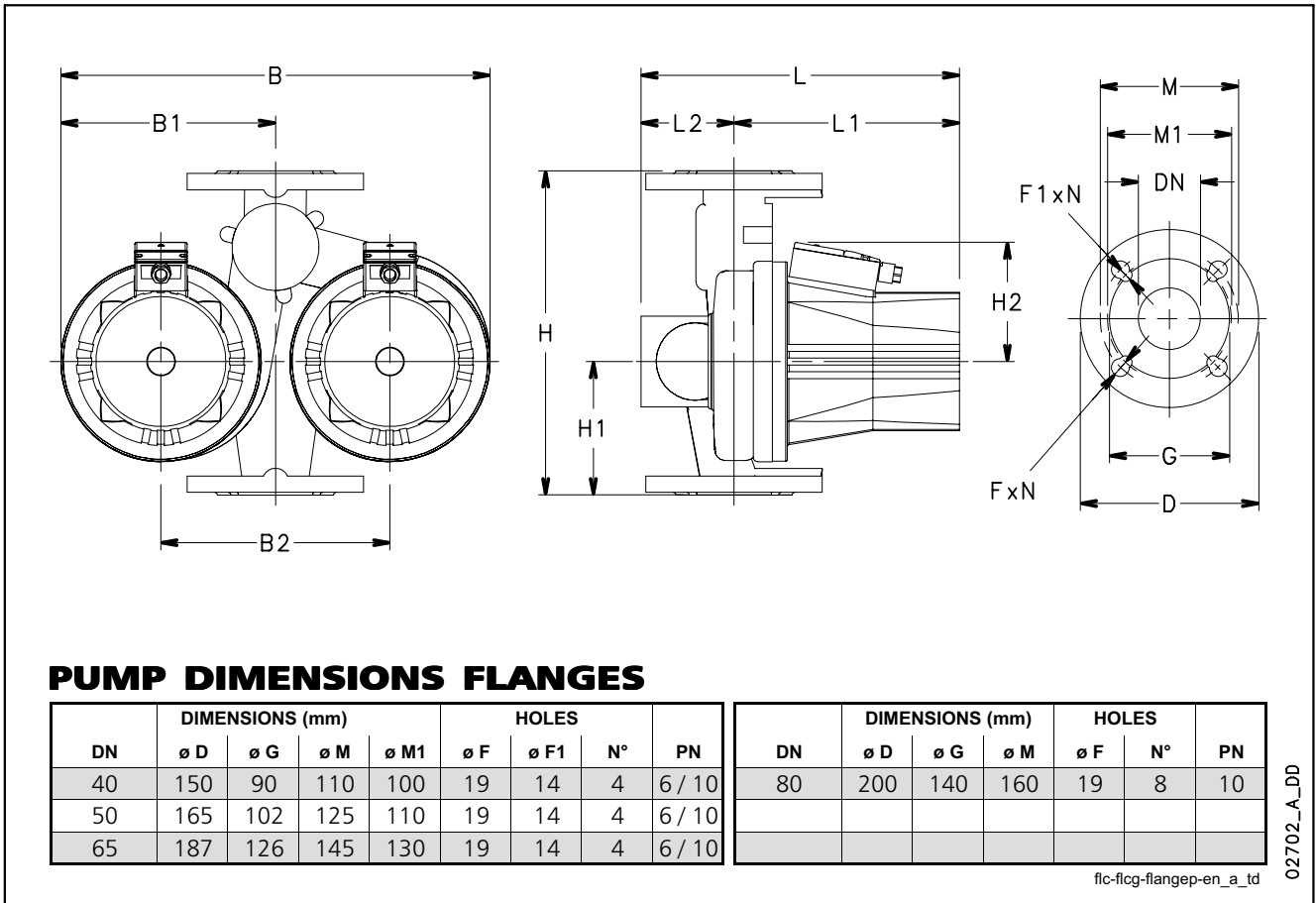

DIMENSIONS AND WEIGHTS TABLE

PUMP TYPE		DIMENSIONS (mm)										WEIGHT	
SINGLE-PHASE	THREE-PHASE	B	B1	B2	H	H1	H2	L	L1	L2	DN	kg	
FLCG 40-5	FLCG 40-5T	344	172	200	250	110	110	222	147	75	40	19	
FLCG 40-7	FLCG 40-7T	344	172	200	250	110	110	222	147	75	40	19	
FLCG 40-10	FLCG 40-10T	348	172	200	250	110	110	265	190	75	40	26	
FLCG 50-5	FLCG 50-5T	387	187	200	280	120	92	280	197	83	50	32	
FLCG 50-8	FLCG 50-8T	387	187	200	280	120	92	280	197	83	50	33	
FLCG 50-10	FLCG 50-10T	400	200	200	280	125	120	310	225	85	50	41	
FLCG 65-7	FLCG 65-7T	450	120	240	340	140	120	329	236	93	65	49	
FLCG 65-10	FLCG 65-10T	450	120	240	340	140	120	329	236	93	65	50	
FLCG 65-12	FLCG 65-12T	450	120	240	340	140	120	329	236	93	65	53	
-	FLCG 65-16T	450	120	240	340	140	120	378	285	93	65	63	
FLCG 80-4	FLCG 80-4T	513	245	275	360	160	175	341	258	83	80	62	
FLCG 80-8	FLCG 80-8T	513	245	275	360	160	175	341	258	83	80	60	
FLCG 80-10	FLCG 80-10T	513	245	275	360	160	175	341	258	83	80	63	
-	FLCG 80-12T	513	245	275	360	160	175	390	307	83	80	77	
-	FLCG 80-15T	513	245	275	360	160	175	390	307	83	80	73	

flcg-2p50-en_a_td

Variable speed circulators for commercial systems

EFLC Series



MARKET SECTORS

COMMERCIAL AND INDUSTRIAL

APPLICATIONS

- Water circulation in heating and cooling systems.
- Pumping of hot/cold liquids, chemically or mechanically non-aggressive, non-explosive, without solids or fiber matter.

SPECIFICATIONS

PUMP

- **Flow rate:** up to 50 m³/h. (90 m³/h with both pumps running).
- **Head:** up to 12 m.
- **Temperature of pumped liquid:** +15°C ÷ +90°C or +15°C ÷ +70°C depending on models (see Product Range Chart).
Avoid condensation and ice formation.
- **Maximum operating pressure:** 10 bar (PN 10).
- **Impeller:** made of cast iron (except for EFLC(G) 40-9, made of composite material).

MOTOR

- Wet rotor type, with bearings lubricated by the pumped liquid. Built-in automatic motor protection with isothermal probes (with external relay, terminals accessible from the terminal board).
- Single-phase 230 V 50 Hz power supply.
- Motor-mounted inverter, with selector switch for mode and operating parameter selection and terminal board for cable connection.
- **Insulation class** 155 (F).
- **Protection class** IP 42.

CONSTRUCTION CHARACTERISTICS

- Electric circulator pumps with in-line suction and discharge ports, designed for direct installation onto piping, DN 40, 50, 65 and 80 mounting flanges.
- Single or twin pump design. The two pumps can operate separately or in parallel in the following manner:
 - Separately: both differential pressure and controlled speed can be selected.
 - Parallel: controlled speed regulation only (speed selection from 1 to 4).
- Rotor shaft made of perforated stainless steel. By enabling water circulation this design ensures:
 - continuous degassing of the rotor chamber, with no need to perform this operation manually during startup;
 - bearing lubrication.
- 2 modes of regulation:
 - Differential pressure.
 - Controlled speed.
- On the terminal box 2 LED indicate the running status:
 - Green LED: normal operation.
 - Red LED: failure detected by the electronics. The light will flash approximately every minute for a specific number of times depending on the error type.
- According to IEC 60335-1 and 60335-2-51 standards.

EFLC Series

Control modes

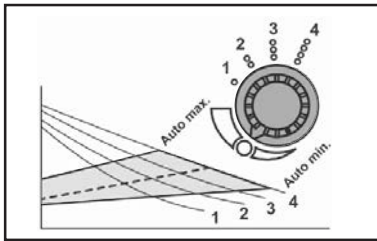

Control:

1. Differential pressure
Thanks to the losses compensation system of the electronics, the controller adjusts the circulator's differential pressure to match the required flow.
2. Controlled speed
The motor running speed is fixed at the value set with the selector between 1 and 4.

ACCESSORIES

- Blind flanges.
- Counterflanges.

INSTALLATION

- Suitable for installation in horizontal or vertical piping, in any position provided that motor axis is horizontal.
- Never install the circulator with the terminal box under the motor(s) (6 o'clock).
- For the twin design installed on horizontal piping, periodic changeover is recommended in order to prevent the formation of water pockets at the top; as an alternative, install an air bleed valve on the flange.
- For installation onto vertical piping the flow should always be upward. If not it is recommended to install an air venting point in the higher point of the circuit at the suction side.

EFLC SERIES IDENTIFICATION CODE

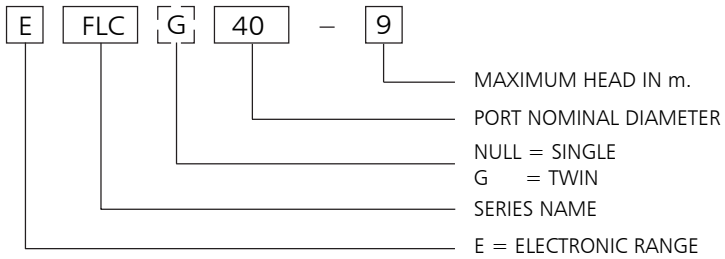

EXAMPLE : EFLCG 40-9

EFLC series electronic circulator, twin version, port nominal diameter = 40,
max head = 9 m.

TABLE OF MATERIALS

PART	MATERIAL
Pump body	Cast iron
Impeller EFLC(G) 40-9	Composite material
Impeller from EFLC(G) 40-11	Cast iron
Shaft	Stainless steel
Jacket	Stainless steel
Bearings	Carbon

eflc-2p50-en_a_tm

EFLC SERIES (SINGLE VERSION, SINGLE-PHASE) HYDRAULIC PERFORMANCE TABLE

PUMP TYPE	POWER ABSORBED		CURRENT ABSORBED		SPEED	Q = DELIVERY										
	MIN W	MAX W	MIN A	MAX A		1/5 0	1,4	2,2	2,8	4,2	5,6	6,9	8,3	9,7	11,1	13,9
						m ³ /h 0	5	8	10	15	20	25	30	35	40	50
230V 50Hz						H = TOTAL HEAD METRES COLUMN OF WATER										
EFLC 40-9	25	300	0,25	1,80	1	5,2	3,2	2,0								
					2	6,3	4,0	2,6								
					3	7,3	4,7	3,2	2,1							
					4	10,5	6,0	3,8	2,4							
					max	4,8	6,0	3,8								
EFLC 40-11	40	650	0,35	3,70	1	5,2	4,6	4,0	3,5	1,6						
					2	6,4	5,7	5,2	4,6	2,8						
					3	7,7	7,1	6,4	5,8	4,0	1,6					
					4	12,0	9,5	8,1	7,1	4,6	2,1					
					max	5,1	6,1	6,7	7,1	4,6						
EFLC 50-12	50	750	0,35	3,50	1	5,2	5,0	4,5	4,1	2,7						
					2	6,7	6,2	5,8	5,4	4,0	2,3					
					3	8,1	7,5	7,1	6,7	5,3	3,6	1,5				
					4	12,7	10,6	9,3	8,5	6,4	4,3	2,2				
					max	5,3	6,6	7,3	7,7	6,4	4,3					
EFLC 65-12	90	1090	0,70	7,70	1	5,1	4,6	4,3	4,1	3,4	2,5	1,4				
					2	6,5	6,0	5,7	5,4	4,7	3,8	2,6	1,3			
					3	8,0	7,5	7,2	6,9	6,1	5,2	4,0	2,7	1,2		
					4	12,5	10,7	9,8	9,2	7,7	6,2	4,8	3,5	2,2		
					max	6,4	6,8	7,1	7,3	7,7	6,2	4,8				
EFLC 80-7	120	1080	1,20	8,00	1	3,7	3,5	3,4	3,2	2,9	2,5	2,1	1,6	1,0		
					2	4,8	4,6	4,5	4,4	4,0	3,6	3,1	2,6	1,9	1,2	
					3	6,0	5,7	5,5	5,4	5,0	4,6	4,1	3,6	3,0	2,4	1,0
					4	6,9	6,6	6,3	6,2	5,7	5,3	4,7	4,1	3,5	2,9	1,7
					max	4,0	4,4	4,7	4,9	5,4	5,3	4,7	4,1	3,5		

Hydraulic performances in compliance with ISO 9906:2012 - Grade 3B (ex ISO 9906:1999 - Annex A)

eflc-2p50-en_d_th

EFLCG SERIES (TWIN VERSION, SINGLE-PHASE) HYDRAULIC PERFORMANCE TABLE (SINGLE OPERATION)

PUMP TYPE	POWER ABSORBED		CURRENT ABSORBED		SPEED	Q = DELIVERY										
	MIN W	MAX W	MIN A	MAX A		l/s 0	1,4	2,2	2,8	4,2	5,6	6,9	8,3	9,7	11,1	13,9
						m ³ /h 0	5	8	10	15	20	25	30	35	40	50
H = TOTAL HEAD METRES COLUMN OF WATER																
EFLCG 40-9	25	300	0,25	1,80	1	5,2	3,2	2,0								
					2	6,3	4,0	2,6								
					3	7,3	4,7	3,2	2,1							
					4	10,5	6,0	3,8	2,4							
					max	4,8	6,0	3,8								
EFLCG 40-11	40	650	0,35	3,70	1	5,2	4,6	4,0	3,5	1,6						
					2	6,4	5,7	5,2	4,6	2,8						
					3	7,7	7,1	6,4	5,8	4,0	1,6					
					4	12,0	9,5	8,1	7,1	4,6	2,1					
					max	5,1	6,1	6,7	7,1	4,6						
EFLCG 50-12	50	750	0,35	3,50	1	5,2	5,0	4,5	4,1	2,7						
					2	6,7	6,2	5,8	5,4	4,0	2,3					
					3	8,1	7,5	7,1	6,7	5,3	3,6	1,5				
					4	12,7	10,6	9,3	8,5	6,4	4,3	2,2				
					max	5,3	6,6	7,3	7,7	6,4	4,3					
EFLCG 65-12	90	1090	0,70	7,70	1	5,1	4,6	4,3	4,1	3,4	2,5	1,4				
					2	6,5	6,0	5,7	5,4	4,7	3,8	2,6	1,3			
					3	8,0	7,5	7,2	6,9	6,1	5,2	4,0	2,7	1,2		
					4	12,5	10,7	9,8	9,2	7,7	6,2	4,8	3,5	2,2		
					max	6,4	6,8	7,1	7,3	7,7	6,2	4,8				
EFLCG 80-7	120	1080	1,20	8,00	1	3,7	3,5	3,4	3,2	2,9	2,5	2,1	1,6	1,0		
					2	4,8	4,6	4,5	4,4	4,0	3,6	3,1	2,6	1,9	1,2	
					3	6,0	5,7	5,5	5,4	5,0	4,6	4,1	3,6	3,0	2,4	1,0
					4	6,9	6,6	6,3	6,2	5,7	5,3	4,7	4,1	3,5	2,9	1,7
					max	4,0	4,4	4,7	4,9	5,4	5,3	4,7	4,1	3,5		

Hydraulic performances in compliance with ISO 9906:2012 - Grade 3B (ex ISO 9906:1999 - Annex A)

eefcg-2p50S-en_e_th

EFLCG SERIES (TWIN VERSION, SINGLE-PHASE) HYDRAULIC PERFORMANCE TABLE (PARALLEL OPERATION)

PUMP TYPE	POWER ABSORBED		CURRENT ABSORBED		SPEED	Q = DELIVERY										
	MIN W*	MAX W*	MIN A*	MAX A*		l/s 0	1,4	2,8	5,0	8,3	11,1	13,9	16,7	19,4	22,2	25,0
						m ³ /h 0	5	10	18	30	40	50	60	70	80	90
H = TOTAL HEAD METRES COLUMN OF WATER																
EFLCG 40-9	25	300	0,25	1,80	1	5,2	4,1	2,9								
					2	6,3	5,0	3,7								
					3	7,3	5,8	4,4	2,1							
					4	10,5	7,9	5,6	2,4							
					max	4,8	5,9	5,6								
EFLCG 40-11	40	650	0,35	3,70	1	5,2	4,8	4,4	3,0							
					2	6,4	5,9	5,5	4,2	1,0						
					3	7,7	7,4	6,8	5,4	2,3						
					4	12,0	10,4	8,9	6,5	2,8						
					max	5,2	5,8	6,4	6,5							
EFLCG 50-12	50	750	0,35	3,50	1	5,2	5,2	4,9	4,1	1,9						
					2	6,7	6,5	6,1	5,3	3,3						
					3	8,1	7,8	7,4	6,6	4,7	2,5					
					4	12,7	11,5	10,3	8,4	5,5	3,1					
					max	5,3	6,0	6,7	7,7	5,5						
EFLCG 65-12	90	1090	0,70	7,70	1	5,1	4,8	4,6	4,1	3,1	2,0	0,8				
					2	6,5	6,2	6,0	5,4	4,4	3,3	1,9				
					3	8,0	7,8	7,5	6,9	5,8	4,7	3,3	1,7			
					4	12,5	11,5	10,6	9,2	7,2	5,6	4,1	2,6			
					max	6,3	6,6	6,9	7,3	7,2	5,6					
EFLCG 80-7	120	1080	1,20	8,00	1	3,7	3,6	3,5	3,3	2,8	2,4	1,9	1,3			
					2	4,8	4,7	4,6	4,4	3,9	3,5	2,9	2,3	1,5		
					3	6,0	5,9	5,7	5,4	4,9	4,4	3,9	3,3	2,7	2,0	1,2
					4	6,9	6,7	6,5	6,2	5,6	5,1	4,5	3,9	3,2	2,5	1,8
					max	4,0	4,2	4,5	4,9	5,5	5,1	4,5				

* Electric data refer to single motor.

eefcg-2p50P-en_e_th

Hydraulic performances in compliance with ISO 9906:2012 - Grade 3B (ex ISO 9906:1999 - Annex A)

EFLC SERIES SINGLE-PHASE OPERATING CHARACTERISTICS

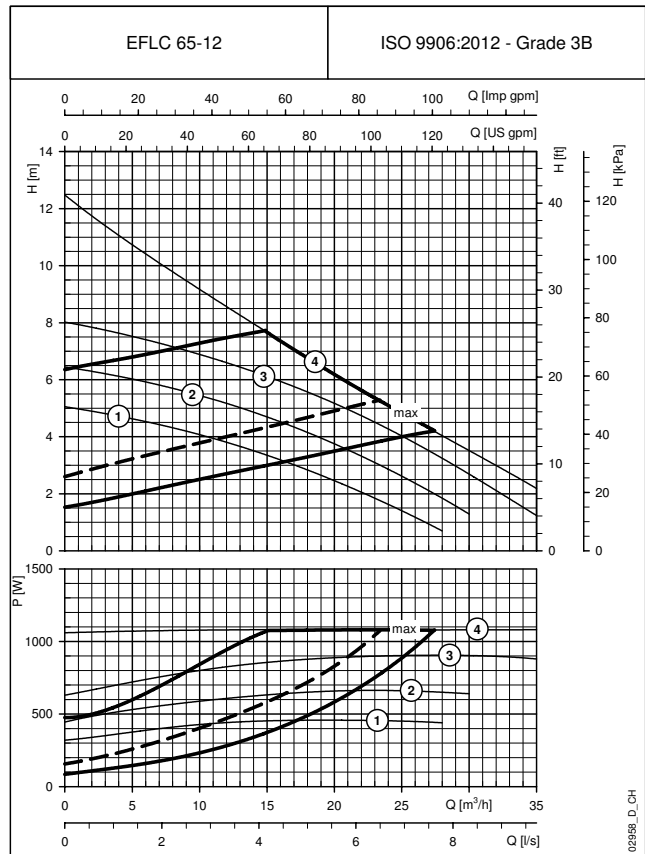
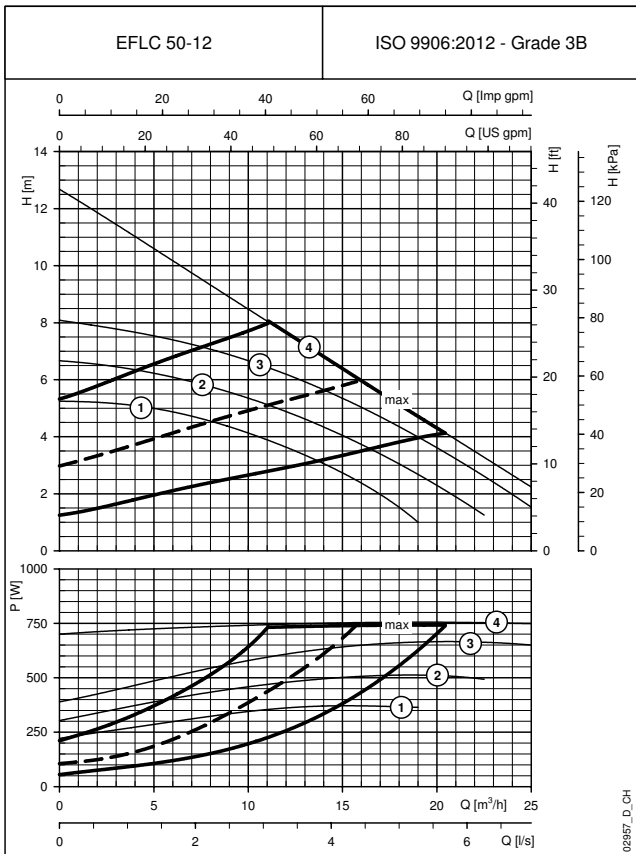
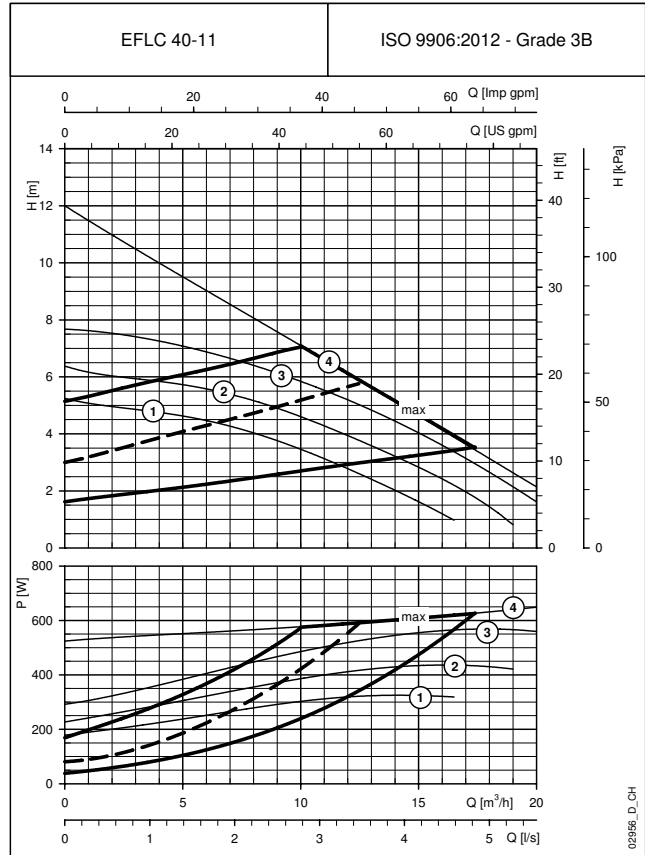
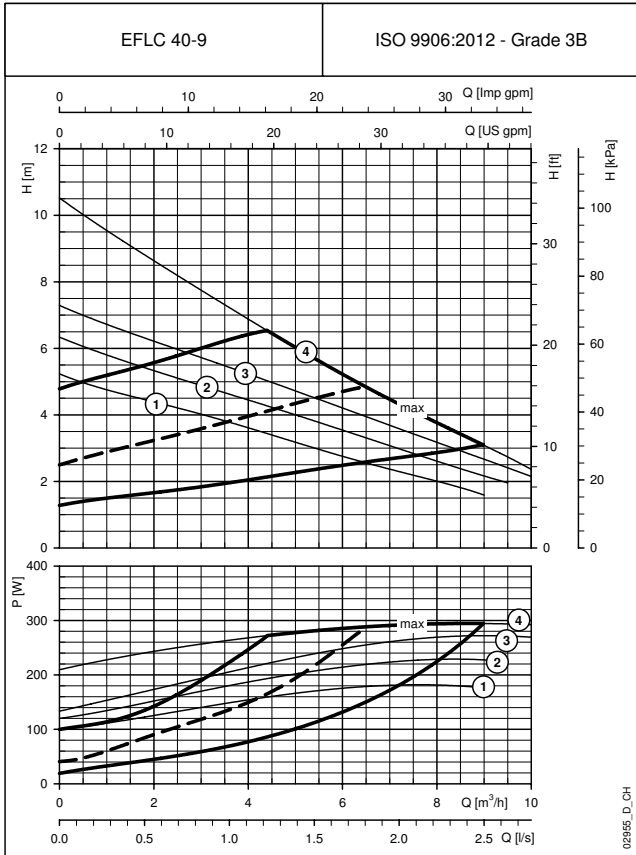

These performances are valid for liquids with density $\rho = 1.0 \text{ Kg/dm}^3$ and kinematic viscosity $\nu = 1 \text{ mm}^2/\text{sec}$.

**EFLC SERIES
SINGLE-PHASE OPERATING CHARACTERISTICS**

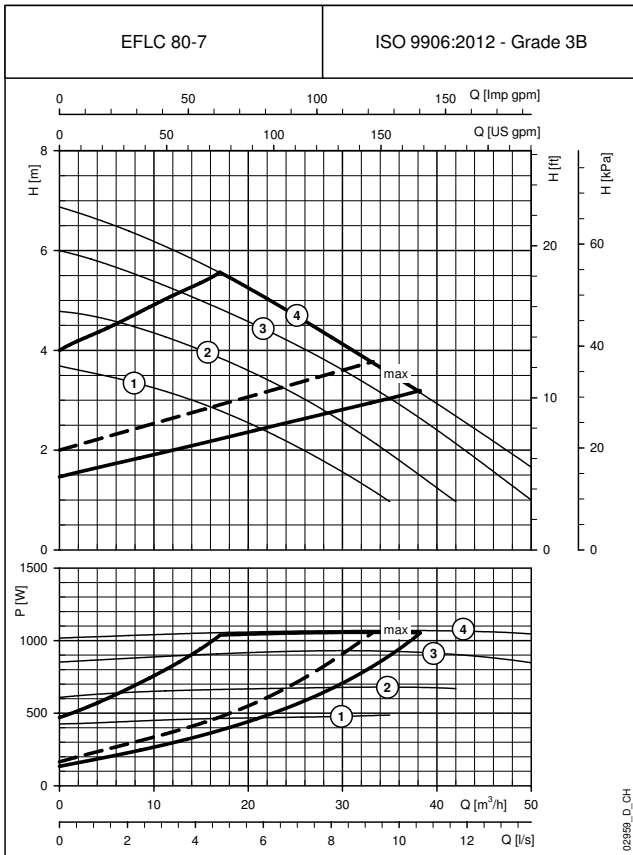

These performances are valid for liquids with density $\rho = 1.0 \text{ Kg/dm}^3$ and kinematic viscosity $\nu = 1 \text{ mm}^2/\text{sec}$.

EFLCG SERIES SINGLE-PHASE OPERATING CHARACTERISTICS

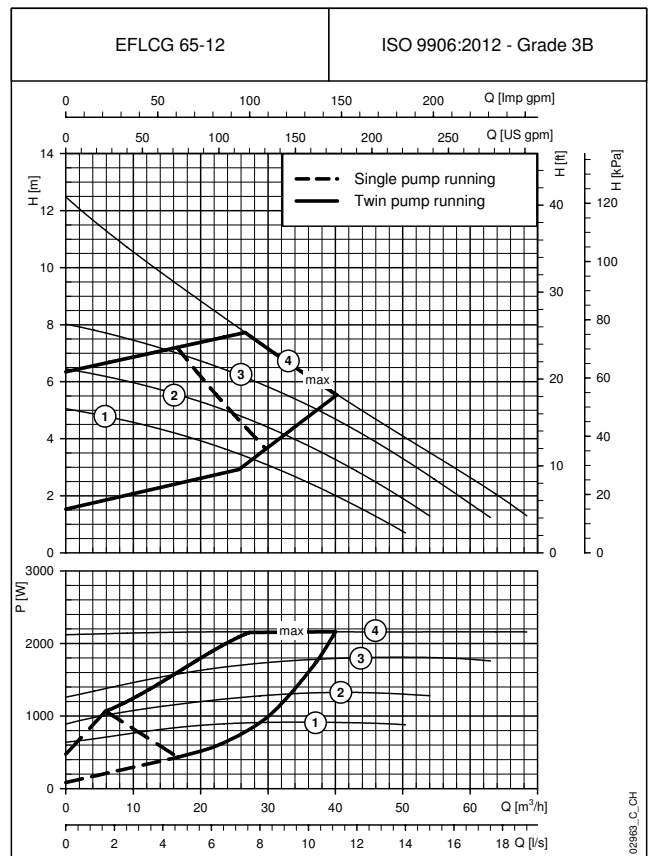
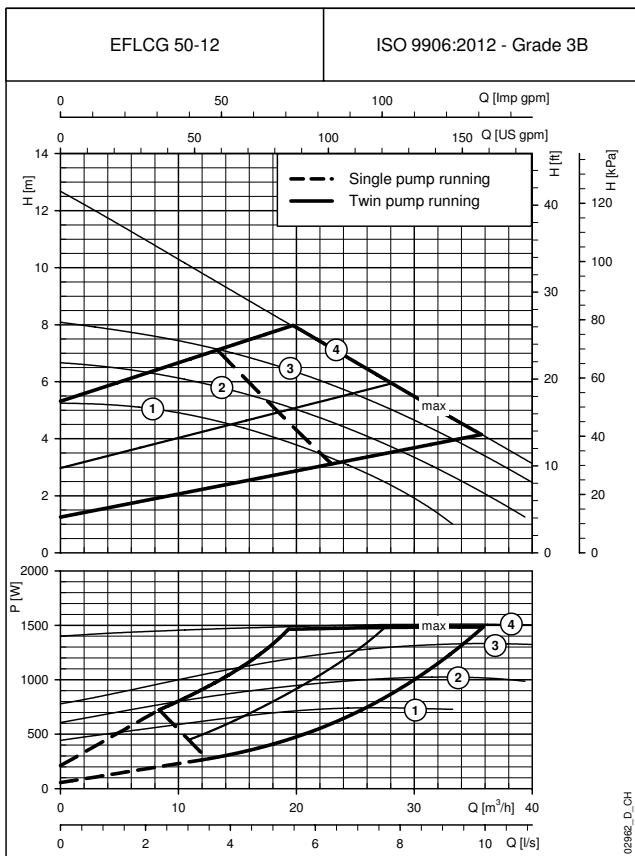
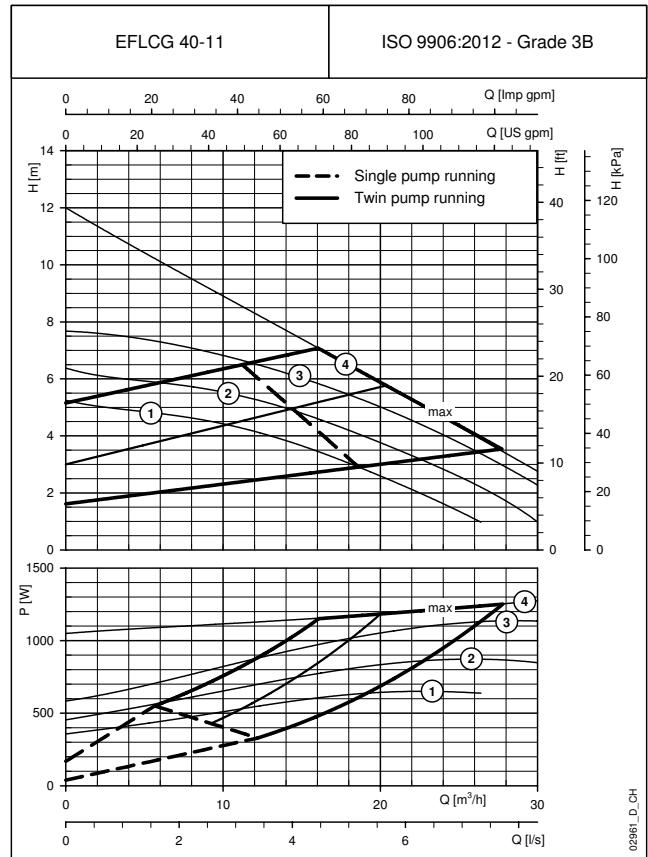
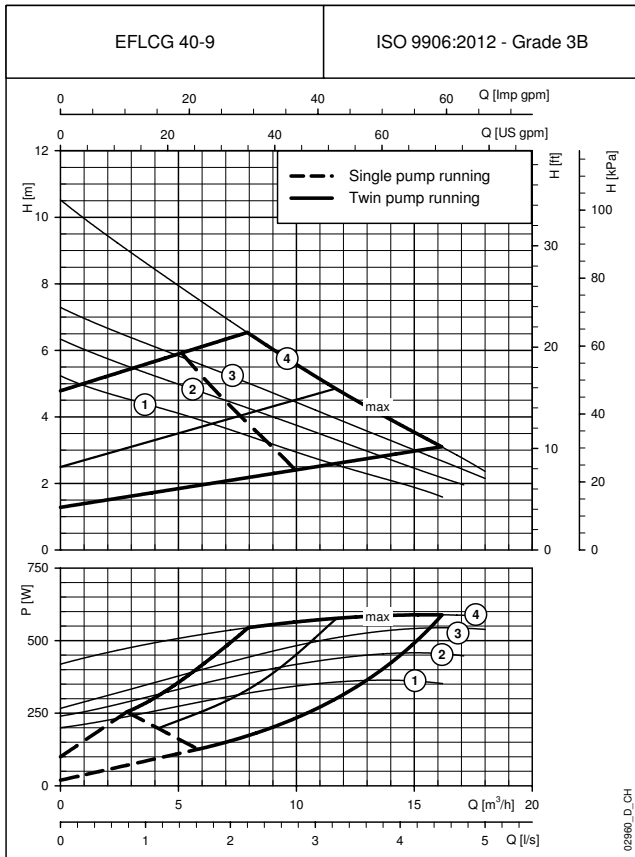

These performances are valid for liquids with density $\rho = 1.0 \text{ Kg/dm}^3$ and kinematic viscosity $\nu = 1 \text{ mm}^2/\text{sec}$.
 For single pump running, refer to EFLC corresponding curves.

**EFLCG SERIES
SINGLE-PHASE OPERATING CHARACTERISTICS**

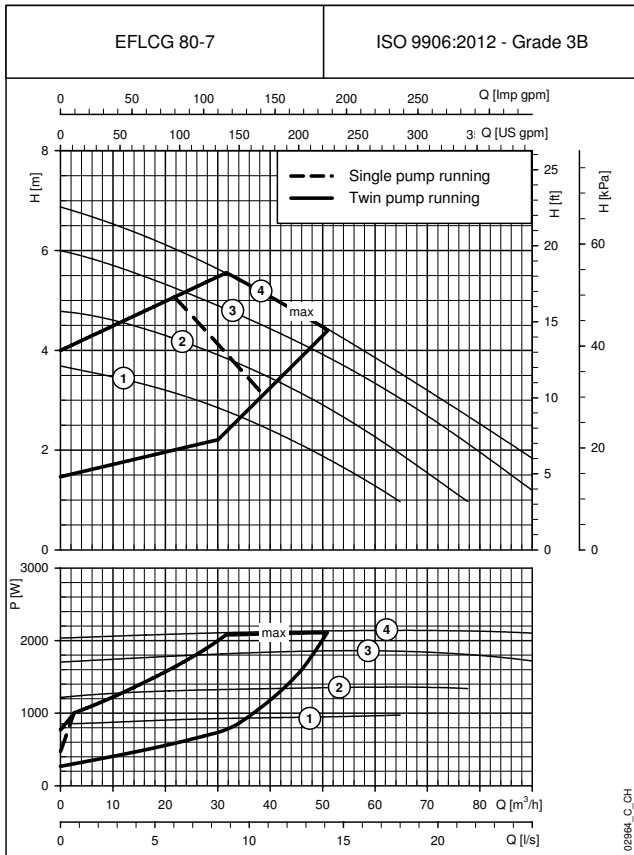

These performances are valid for liquids with density $\rho = 1.0 \text{ Kg/dm}^3$ and kinematic viscosity $\nu = 1 \text{ mm}^2/\text{sec}$.
For single pump running, refer to EFLC corresponding curves.

EFLC SERIES DIMENSIONS AND WEIGHTS

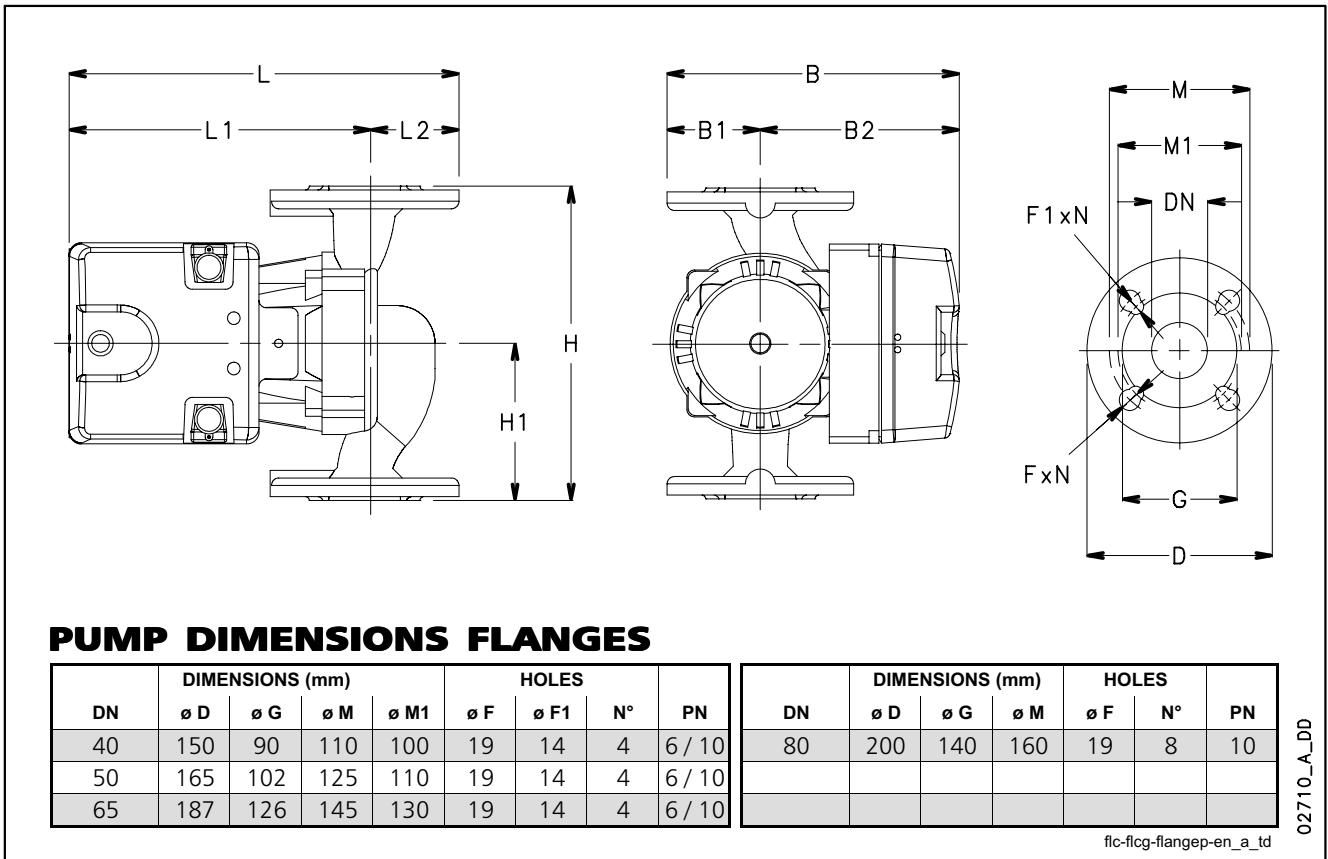

DIMENSIONS AND WEIGHTS TABLE

PUMP TYPE	DIMENSIONS (mm)									WEIGHT	
	B	B1	B2	H	H1	L	L1	L2	DN	kg	
EFLC 40-9	235	75	160	250	125	300	230	70	40	13	
EFLC 40-11	235	75	160	250	125	310	235	75	40	16	
EFLC 50-12	248	83	165	280	140	315	230	85	50	20	
EFLC 65-12	275	100	175	340	170	346	256	90	65	30	
EFLC 80-7	285	110	175	360	180	351	246	105	80	36	

efc-2p50-en_a_td

EFLCG SERIES DIMENSIONS AND WEIGHTS

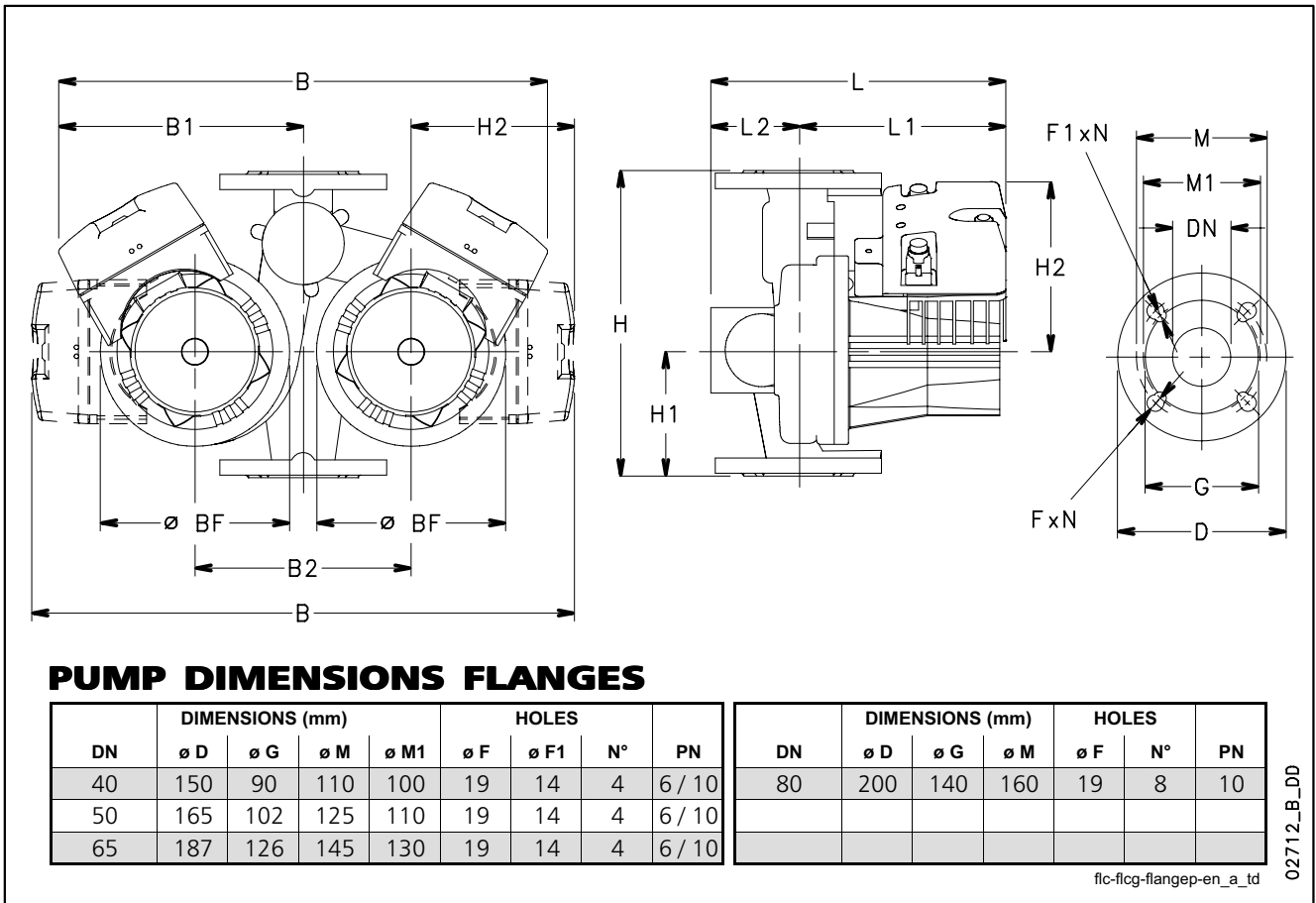

DIMENSIONS AND WEIGHTS TABLE

PUMP TYPE	DIMENSIONS (mm)											WEIGHT kg
	B	B1	B2	H	H1	H2	L	L1	L2	ø BF	DN	
EFLCG 40-9	436	218	200	250	105	170	287	212	75	135	40	22
EFLCG 40-11	520	265	200	250	105	165	304	229	75	135	40	29
EFLCG 50-12	490	245	200	280	120	170	317	198	83	161	50	35
EFLCG 65-12	528	300	275	340	140	180	328	235	93	210	65	54
EFLCG 80-7	660	340	275	360	100	180	342	240	102	210	80	70

eefcg-2p50-en_c_td

**TLC, TLCH SERIES
INSTALLATION POSITIONS**

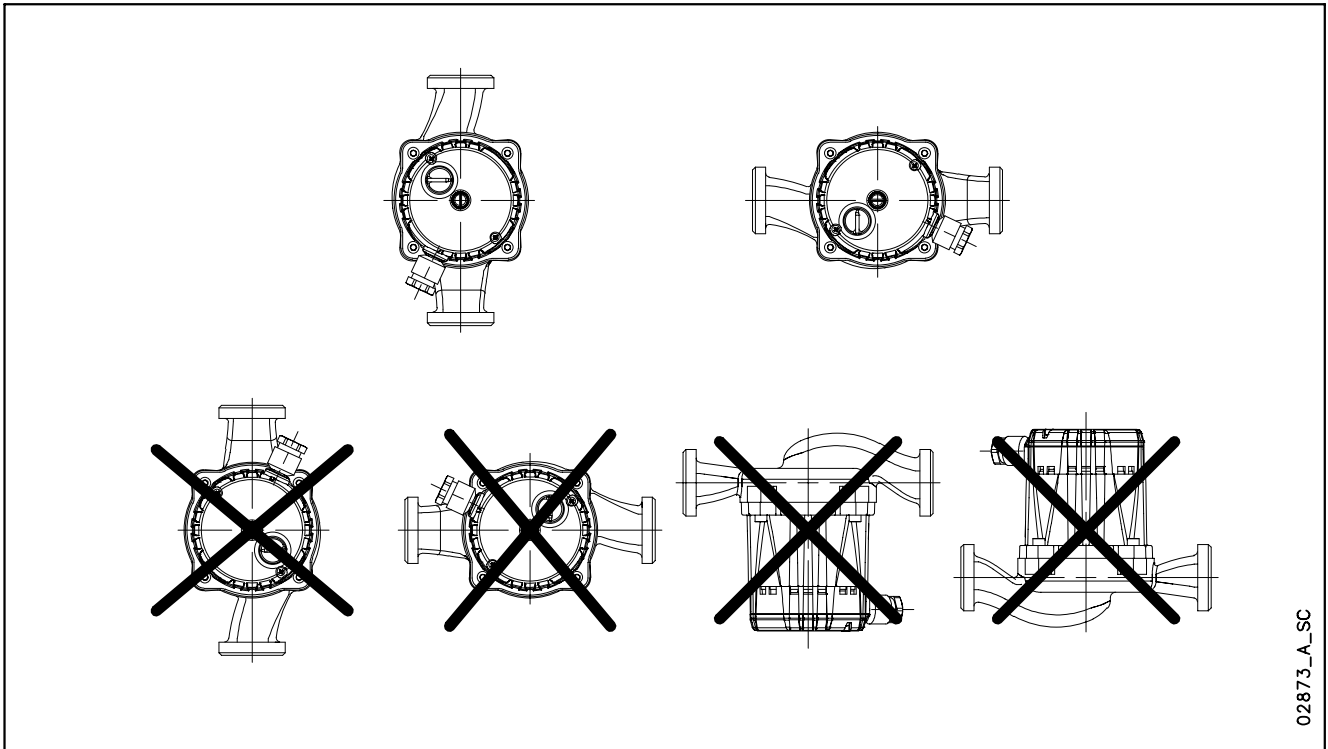

02873_A_SC

**FLC, FLCG SERIES
INSTALLATION POSITIONS**

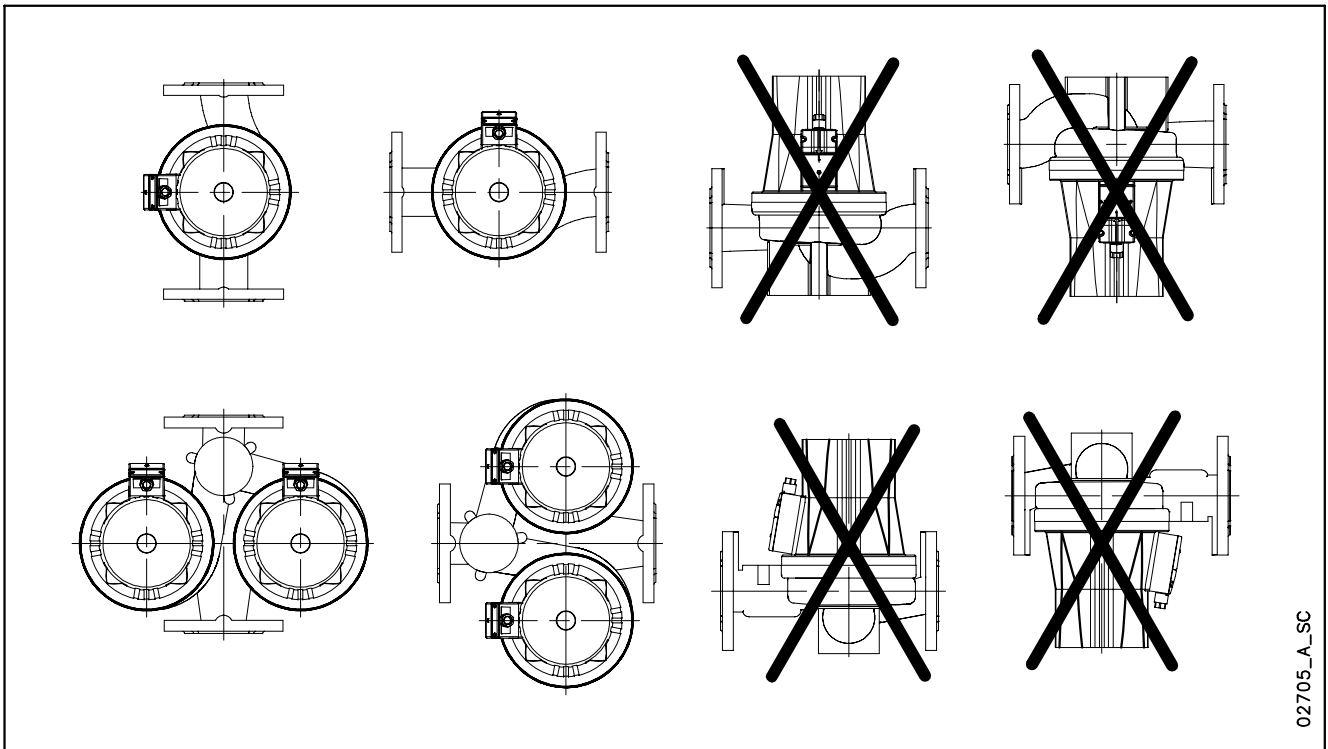

02705_A_SC

**EFLC SERIES
INSTALLATION POSITIONS**

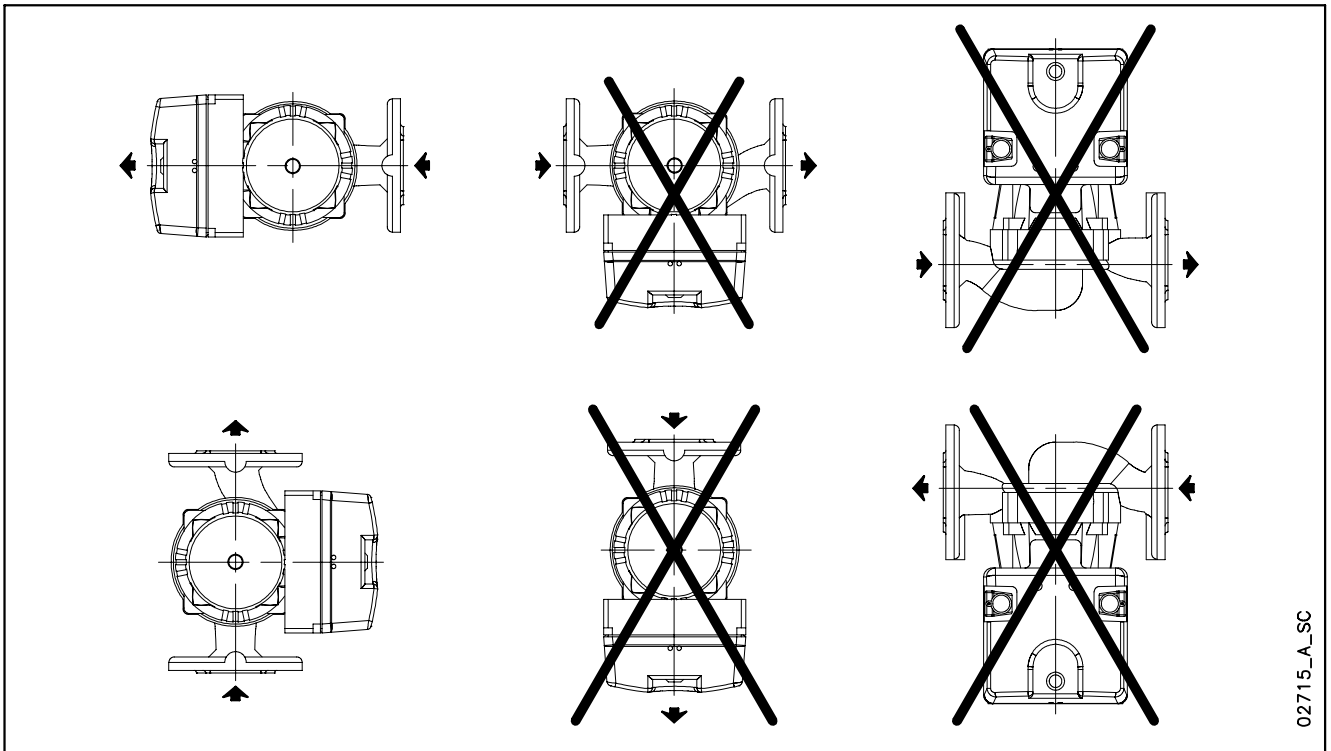

**EFLCG SERIES
INSTALLATION POSITIONS**

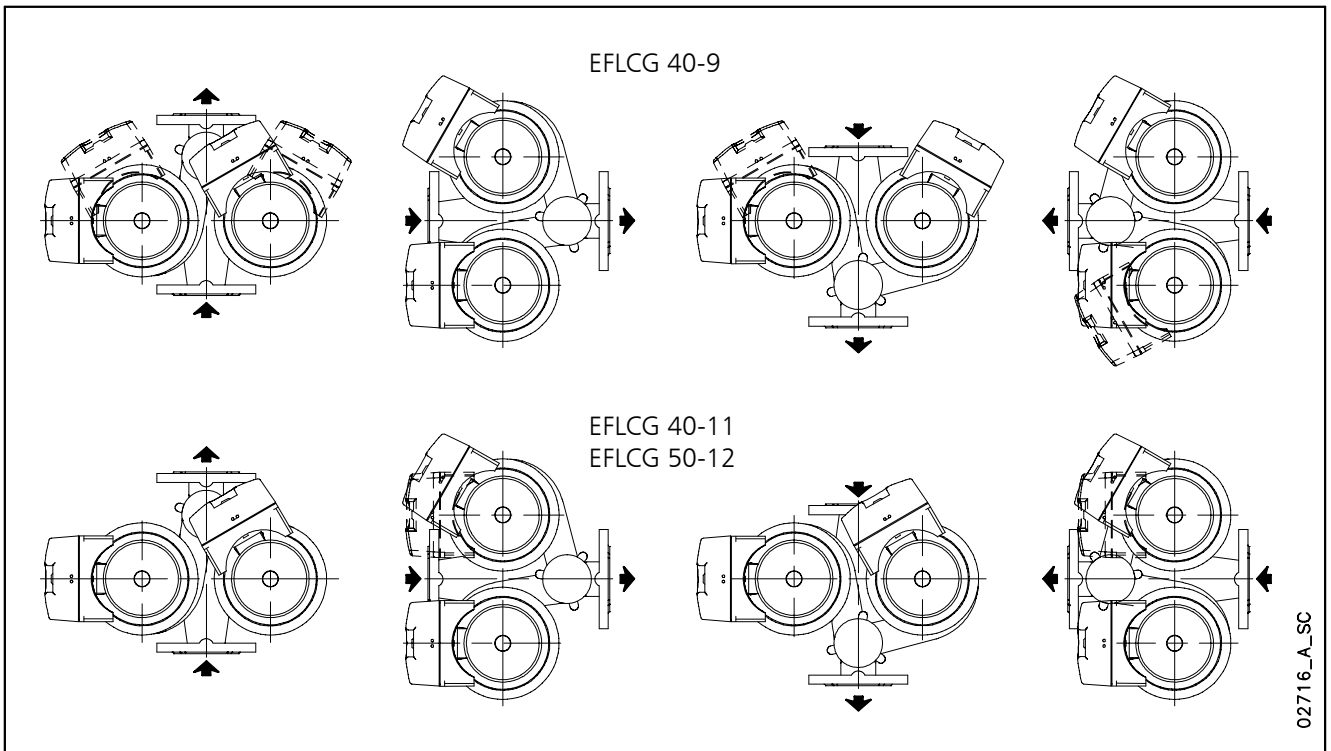

TECHNICAL APPENDIX

VAPOUR PRESSURE VAPOUR PRESSURE p_s AND ρ DENSITY OF WATER TABLE

t °C	T K	p_s bar	ρ kg/dm ³	t °C	T K	p_s bar	ρ kg/dm ³	t °C	T K	p_s bar	ρ kg/dm ³
0	273,15	0,00611	0,9998	55	328,15	0,15741	0,9857	120	393,15	1,9854	0,9429
1	274,15	0,00657	0,9999	56	329,15	0,16511	0,9852	122	395,15	2,1145	0,9412
2	275,15	0,00706	0,9999	57	330,15	0,17313	0,9846	124	397,15	2,2504	0,9396
3	276,15	0,00758	0,9999	58	331,15	0,18147	0,9842	126	399,15	2,3933	0,9379
4	277,15	0,00813	1,0000	59	332,15	0,19016	0,9837	128	401,15	2,5435	0,9362
5	278,15	0,00872	1,0000	60	333,15	0,1992	0,9832	130	403,15	2,7013	0,9346
6	279,15	0,00935	1,0000	61	334,15	0,2086	0,9826	132	405,15	2,867	0,9328
7	280,15	0,01001	0,9999	62	335,15	0,2184	0,9821	134	407,15	3,041	0,9311
8	281,15	0,01072	0,9999	63	336,15	0,2286	0,9816	136	409,15	3,223	0,9294
9	282,15	0,01147	0,9998	64	337,15	0,2391	0,9811	138	411,15	3,414	0,9276
10	283,15	0,01227	0,9997	65	338,15	0,2501	0,9805	140	413,15	3,614	0,9258
11	284,15	0,01312	0,9997	66	339,15	0,2615	0,9799	145	418,15	4,155	0,9214
12	285,15	0,01401	0,9996	67	340,15	0,2733	0,9793	155	428,15	5,433	0,9121
13	286,15	0,01497	0,9994	68	341,15	0,2856	0,9788	160	433,15	6,181	0,9073
14	287,15	0,01597	0,9993	69	342,15	0,2984	0,9782	165	438,15	7,008	0,9024
15	288,15	0,01704	0,9992	70	343,15	0,3116	0,9777	170	433,15	7,920	0,8973
16	289,15	0,01817	0,9990	71	344,15	0,3253	0,9770	175	448,15	8,924	0,8921
17	290,15	0,01936	0,9988	72	345,15	0,3396	0,9765	180	453,15	10,027	0,8869
18	291,15	0,02062	0,9987	73	346,15	0,3543	0,9760	185	458,15	11,233	0,8815
19	292,15	0,02196	0,9985	74	347,15	0,3696	0,9753	190	463,15	12,551	0,8760
20	293,15	0,02337	0,9983	75	348,15	0,3855	0,9748	195	468,15	13,987	0,8704
21	294,15	0,24850	0,9981	76	349,15	0,4019	0,9741	200	473,15	15,550	0,8647
22	295,15	0,02642	0,9978	77	350,15	0,4189	0,9735	205	478,15	17,243	0,8588
23	296,15	0,02808	0,9976	78	351,15	0,4365	0,9729	210	483,15	19,077	0,8528
24	297,15	0,02982	0,9974	79	352,15	0,4547	0,9723	215	488,15	21,060	0,8467
25	298,15	0,03166	0,9971	80	353,15	0,4736	0,9716	220	493,15	23,198	0,8403
26	299,15	0,03360	0,9968	81	354,15	0,4931	0,9710	225	498,15	25,501	0,8339
27	300,15	0,03564	0,9966	82	355,15	0,5133	0,9704	230	503,15	27,976	0,8273
28	301,15	0,03778	0,9963	83	356,15	0,5342	0,9697	235	508,15	30,632	0,8205
29	302,15	0,04004	0,9960	84	357,15	0,5557	0,9691	240	513,15	33,478	0,8136
30	303,15	0,04241	0,9957	85	358,15	0,5780	0,9684	245	518,15	36,523	0,8065
31	304,15	0,04491	0,9954	86	359,15	0,6011	0,9678	250	523,15	39,776	0,7992
32	305,15	0,04753	0,9951	87	360,15	0,6249	0,9671	255	528,15	43,246	0,7916
33	306,15	0,05029	0,9947	88	361,15	0,6495	0,9665	260	533,15	46,943	0,7839
34	307,15	0,05318	0,9944	89	362,15	0,6749	0,9658	265	538,15	50,877	0,7759
35	308,15	0,05622	0,9940	90	363,15	0,7011	0,9652	270	543,15	55,058	0,7678
36	309,15	0,05940	0,9937	91	364,15	0,7281	0,9644	275	548,15	59,496	0,7593
37	310,15	0,06274	0,9933	92	365,15	0,7561	0,9638	280	553,15	64,202	0,7505
38	311,15	0,06624	0,9930	93	366,15	0,7849	0,9630	285	558,15	69,186	0,7415
39	312,15	0,06991	0,9927	94	367,15	0,8146	0,9624	290	563,15	74,461	0,7321
40	313,15	0,07375	0,9923	95	368,15	0,8453	0,9616	295	568,15	80,037	0,7223
41	314,15	0,07777	0,9919	96	369,15	0,8769	0,9610	300	573,15	85,927	0,7122
42	315,15	0,08198	0,9915	97	370,15	0,9094	0,9602	305	578,15	92,144	0,7017
43	316,15	0,09639	0,9911	98	371,15	0,9430	0,9596	310	583,15	98,70	0,6906
44	317,15	0,09100	0,9907	99	372,15	0,9776	0,9586	315	588,15	105,61	0,6791
45	318,15	0,09582	0,9902	100	373,15	1,0133	0,9581	320	593,15	112,89	0,6669
46	319,15	0,10086	0,9898	102	375,15	1,0878	0,9567	325	598,15	120,56	0,6541
47	320,15	0,10612	0,9894	104	377,15	1,1668	0,9552	330	603,15	128,63	0,6404
48	321,15	0,11162	0,9889	106	379,15	1,2504	0,9537	340	613,15	146,05	0,6102
49	322,15	0,11736	0,9884	108	381,15	1,3390	0,9522	350	623,15	165,35	0,5743
50	323,15	0,12335	0,9880	110	383,15	1,4327	0,9507	360	633,15	186,75	0,5275
51	324,15	0,12961	0,9876	112	385,15	1,5316	0,9491	370	643,15	210,54	0,4518
52	325,15	0,13613	0,9871	114	387,15	1,6362	0,9476	374,15	647,30	221,20	0,3154
53	326,15	0,14293	0,9862	116	389,15	1,7465	0,9460				
54	327,15	0,15002	0,9862	118	391,15	1,8628	0,9445				

G-at_npsb_sc

TABLE OF FLOW RESISTANCE IN 100 m OF STRAIGHT CAST IRON PIPELINE (HAZEN-WILLIAMS FORMULA C=100)

FLOW RATE		NOMINAL DIAMETER in mm and inches																		
m ³ /h	l/min		15	20	25	32	40	50	65	80	100	125	150	175	200	250	300	350	400	
			1/2"	3/4"	1"	1 1/4"	1 1/2"	2	2 1/2"	3"	4"	5"	6"	7"	8"	10"	12"	14"	16"	
0,6	10	v	0,94	0,53	0,34	0,21	0,13													
		hr	16	3,94	1,33	0,40	0,13													
0,9	15	v	1,42	0,80	0,51	0,31	0,20													
		hr	33,9	8,35	2,82	0,85	0,29													
1,2	20	v	1,89	1,06	0,68	0,41	0,27	0,17												
		hr	57,7	14,21	4,79	1,44	0,49	0,16												
1,5	25	v	2,36	1,33	0,85	0,52	0,33	0,21												
		hr	87,2	21,5	7,24	2,18	0,73	0,25												
1,8	30	v	2,83	1,59	1,02	0,62	0,40	0,25												
		hr	122	30,1	10,1	3,05	1,03	0,35												
2,1	35	v	3,30	1,86	1,19	0,73	0,46	0,30												
		hr	162	40,0	13,5	4,06	1,37	0,46												
2,4	40	v		2,12	1,36	0,83	0,53	0,34	0,20											
		hr		51,2	17,3	5,19	1,75	0,59	0,16											
3	50	v		2,65	1,70	1,04	0,66	0,42	0,25											
		hr		77,4	26,1	7,85	2,65	0,89	0,25											
3,6	60	v		3,18	2,04	1,24	0,80	0,51	0,30											
		hr		108	36,6	11,0	3,71	1,25	0,35											
4,2	70	v		3,72	2,38	1,45	0,93	0,59	0,35											
		hr		144	48,7	14,6	4,93	1,66	0,46											
4,8	80	v		4,25	2,72	1,66	1,06	0,68	0,40											
		hr		185	62,3	18,7	6,32	2,13	0,59											
5,4	90	v			3,06	1,87	1,19	0,76	0,45	0,30										
		hr			77,5	23,3	7,85	2,65	0,74	0,27										
6	100	v			3,40	2,07	1,33	0,85	0,50	0,33										
		hr			94,1	28,3	9,54	3,22	0,90	0,33										
7,5	125	v			4,25	2,59	1,66	1,06	0,63	0,41										
		hr			142	42,8	14,4	4,86	1,36	0,49										
9	150	v				3,11	1,99	1,27	0,75	0,50	0,32									
		hr				59,9	20,2	6,82	1,90	0,69	0,23									
10,5	175	v				3,63	2,32	1,49	0,88	0,58	0,37									
		hr				79,7	26,9	9,07	2,53	0,92	0,31									
12	200	v				4,15	2,65	1,70	1,01	0,66	0,42									
		hr				102	34,4	11,6	3,23	1,18	0,40									
15	250	v				5,18	3,32	2,12	1,26	0,83	0,53	0,34								
		hr				154	52,0	17,5	4,89	1,78	0,60	0,20								
18	300	v					3,98	2,55	1,51	1,00	0,64	0,41								
		hr					72,8	24,6	6,85	2,49	0,84	0,28								
24	400	v					5,31	3,40	2,01	1,33	0,85	0,54	0,38							
		hr					124	41,8	11,66	4,24	1,43	0,48	0,20							
30	500	v					6,63	4,25	2,51	1,66	1,06	0,68	0,47							
		hr					187	63,2	17,6	6,41	2,16	0,73	0,30							
36	600	v						5,10	3,02	1,99	1,27	0,82	0,57	0,42						
		hr						88,6	24,7	8,98	3,03	1,02	0,42	0,20						
42	700	v						5,94	3,52	2,32	1,49	0,95	0,66	0,49						
		hr						118	32,8	11,9	4,03	1,36	0,56	0,26						
48	800	v						6,79	4,02	2,65	1,70	1,09	0,75	0,55						
		hr						151	42,0	15,3	5,16	1,74	0,72	0,34						
54	900	v						7,64	4,52	2,99	1,91	1,22	0,85	0,62						
		hr						188	52,3	19,0	6,41	2,16	0,89	0,42						
60	1000	v							5,03	3,32	2,12	1,36	0,94	0,69	0,53					
		hr							63,5	23,1	7,79	2,63	1,08	0,51	0,27					
75	1250	v							6,28	4,15	2,65	1,70	1,18	0,87	0,66					
		hr							96,0	34,9	11,8	3,97	1,63	0,77	0,40					
90	1500	v							7,54	4,98	3,18	2,04	1,42	1,04	0,80					
		hr							134	48,9	16,5	5,57	2,29	1,08	0,56					
105	1750	v							8,79	5,81	3,72	2,38	1,65	1,21	0,93					
		hr							179	65,1	21,9	7,40	3,05	1,44	0,75					
120	2000	v								6,63	4,25	2,72	1,89	1,39	1,06	0,68				
		hr								83,3	28,1	9,48	3,90	1,84	0,96	0,32				
150	2500	v								8,29	5,31	3,40	2,36	1,73	1,33	0,85				
		hr								126	42,5	14,3	5,89	2,78	1,45	0,49				
180	3000	v									6,37	4,08	2,83	2,08	1,59	1,02	0,71			
		hr									59,5	20,1	8,26	3,90	2,03	0,69	0,28			
210	3500	v									7,43	4,76	3,30	2,43	1,86	1,19	0,83			
		hr									79,1	26,7	11,0	5,18	2,71	0,91	0,38			
240	4000	v									8,49	5,44	3,77	2,77	2,12	1,36	0,94			
		hr									101	34,2	14,1	6,64	3,46	1,17	0,48			
300	5000	v										6,79	4,72	3,47	2,65	1,70	1,18			
		hr										51,6	21,2	10,0	5,23	1,77	0,73			
360	6000	v										8,15	5,66	4,16	3,18	2,04	1,42			
		hr										72,3	29,8	14,1	7,33	2,47	1,02			
420	7000	v											6,61	4,85	3,72	2,38	1,65	1,21		
		hr											39,6	18,7	9,75	3,29	1,35	0,64		
480	8000	v											7,55	5,55	4,25	2,72	1,89	1,39		
		hr											50,7	23,9	12,49	4,21	1,73	0,82		
540	9000	v											8,49	6,24	4,78	3,06	2,12	1,56	1,19	
		hr											63,0	29,8	15,5	5,24	2,16	1,02	0,53	
600	10000	v												6,93	5,31	3,40	2,36	1,73	1,33	
		hr																		

FLOW RESISTANCE

TABLE OF FLOW RESISTANCE IN BENDS, VALVES AND GATES

The flow resistance is calculated using the equivalent pipeline length method according to the table below:

ACCESSORY TYPE	DN											
	25	32	40	50	65	80	100	125	150	200	250	300
	Equivalent pipeline length (m)											
45° bend	0,2	0,2	0,4	0,4	0,6	0,6	0,9	1,1	1,5	1,9	2,4	2,8
90° bend	0,4	0,6	0,9	1,1	1,3	1,5	2,1	2,6	3,0	3,9	4,7	5,8
90° smooth bend	0,4	0,4	0,4	0,6	0,9	1,1	1,3	1,7	1,9	2,8	3,4	3,9
Union tee or cross	1,1	1,3	1,7	2,1	2,6	3,2	4,3	5,3	6,4	7,5	10,7	12,8
Gate	-	-	-	0,2	0,2	0,2	0,4	0,4	0,6	0,9	1,1	1,3
Non return valve	1,1	1,5	1,9	2,4	3,0	3,4	4,7	5,9	7,4	9,6	11,8	13,9

G-a-pcv-en_a_th

The table is valid for the Hazen Williams coefficient $C=100$ (cast iron pipework);

for steel pipework, multiply the values by 1,41;

for stainless steel, copper and coated cast iron pipework, multiply the values by 1,85;

When the **equivalent pipeline length** has been determined, the flow resistance is obtained from the table of flow resistance.

The values given are guideline values which are bound to vary slightly according to the model, especially for gate valves and non-return valves, for which it is a good idea to check the values supplied by manufacturers.

VOLUMETRIC CAPACITY

Litres per minute l/min	Cubic metres per hour m ³ /h	Cubic feet per hour ft ³ /h	Cubic feet per minute ft ³ /min	Imp. gal. per minute Imp. gal./min	US gal. per minute Us gal./min
1,000	0,0600	2,1189	0,0353	0,2200	0,2642
16,6667	1,000	35,3147	0,5886	3,6662	4,4029
0,4719	0,0283	1,000	0,0167	0,1038	0,1247
28,3168	1,6990	60,0000	1,000	6,2288	7,4805
4,5461	0,2728	9,6326	0,1605	1,000	1,2009
3,7854	0,2271	8,0208	0,1337	0,8327	1,000

PRESSURE AND HEAD

Newton per square metre N/m ²	kilo Pascal kPa	bar bar	Pound force per square inch psi	metre of water m H ₂ O	millimetre of mercury mm Hg
1,000	0,0010	1 x 10 ⁻⁵	1.45 x 10 ⁻⁴	1.02 x 10 ⁻⁴	0,0075
1000,0000	1,000	0,0100	0,1450	0,1020	7,5006
1 x 10 ⁵	100,0000	1,000	14,5038	10,1972	750,0638
6894,7570	6,8948	0,0689	1,000	0,7031	51,7151
9806,6500	9,8067	0,0981	1,4223	1,000	73,5561
133,3220	0,1333	0,0013	0,0193	0,0136	1,000

LENGTH

millimetre mm	centimetre cm	metre m	inch in	foot ft	yard yd
1,000	0,1000	0,0010	0,0394	0,0033	0,0011
10,0000	1,000	0,0100	0,3937	0,0328	0,0109
1000,0000	100,0000	1,000	39,3701	3,2808	1,0936
25,4000	2,5400	0,0254	1,000	0,0833	0,0278
304,8000	30,4800	0,3048	12,0000	1,000	0,3333
914,4000	91,4400	0,9144	36,0000	3,0000	1,000

VOLUME

cubic metre m ³	litre litro	millilitre ml	imp. Gallon imp. gal.	US gallon US gal.	cubic foot ft ³
1,000	1000,0000	1 x 10 ⁶	219,9694	264,1720	35,3147
0,0010	1,000	1000,0000	0,2200	0,2642	0,0353
1 x 10 ⁻⁶	0,0010	1,000	2.2 x 10 ⁻⁴	2.642 x 10 ⁻⁴	3.53 x 10 ⁻⁵
0,0045	4,5461	4546,0870	1,000	1,2009	0,1605
0,0038	3,7854	3785,4120	0,8327	1,000	0,1337
0,0283	28,3168	28316,8466	6,2288	7,4805	1,000

G-at_pp-en_a_sc

FURTHER PRODUCT SELECTION AND DOCUMENTATION

Xylect™

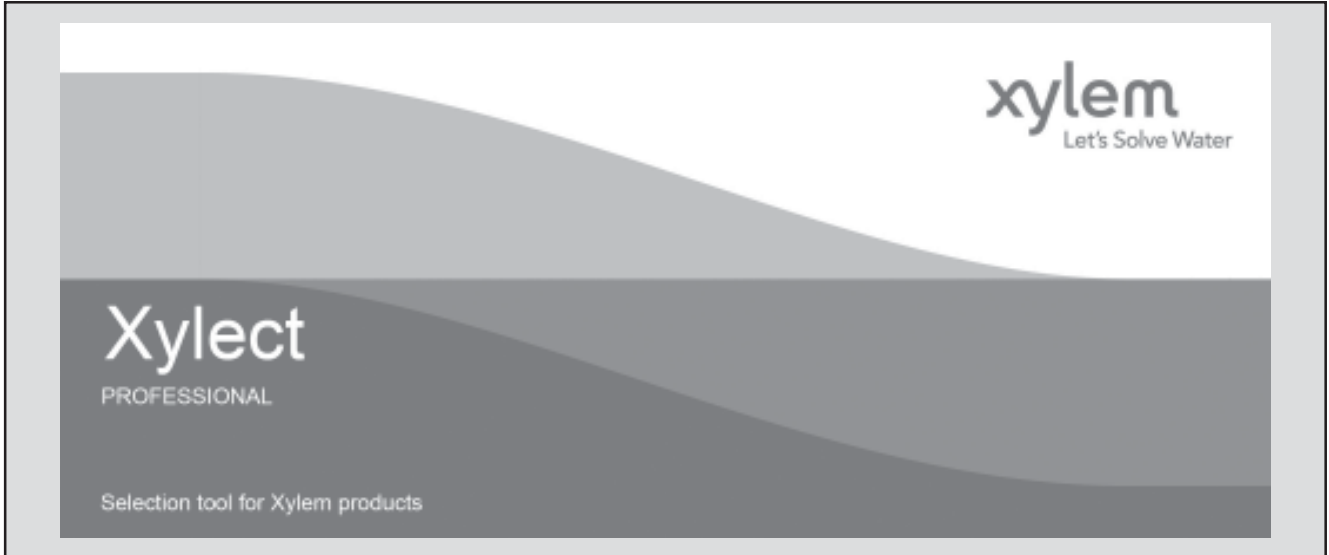

Xylect™ is pump solution selection software with an extensive online database of product information across the entire Lowara, and Vogel range of pumps and related products, with multiple search options and helpful project management facilities. The system holds up-to-date product information on thousands of products and accessories.

The possibility to search by applications and the detailed information output given makes it easy to make the optimal selection without having detailed knowledge about the Lowara and Vogel products.

The search can be made by:

- Application
- Product type
- Duty point

Xylect™ gives a detailed output:

- List with search results
- Performance curves (flow, head, power, efficiency, NPSH)
- Motor data
- Dimensional drawings
- Options
- Data sheet printouts
- Document downloads incl dxf files

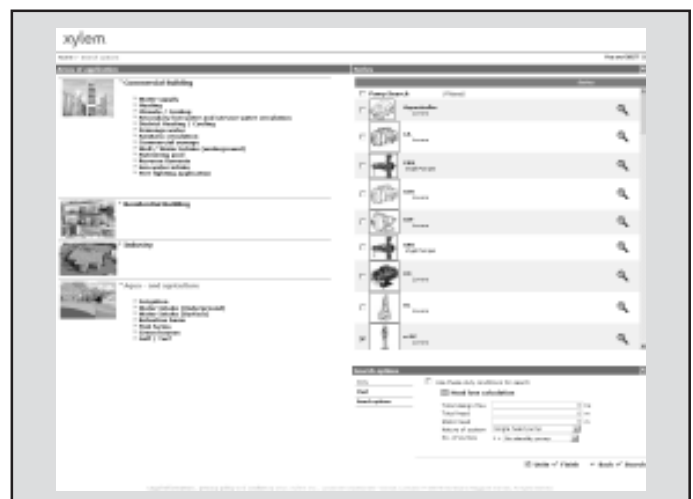

The search by application guides users not familiar with the product range to the right choice.

FURTHER PRODUCT SELECTION AND DOCUMENTATION

Xylect™

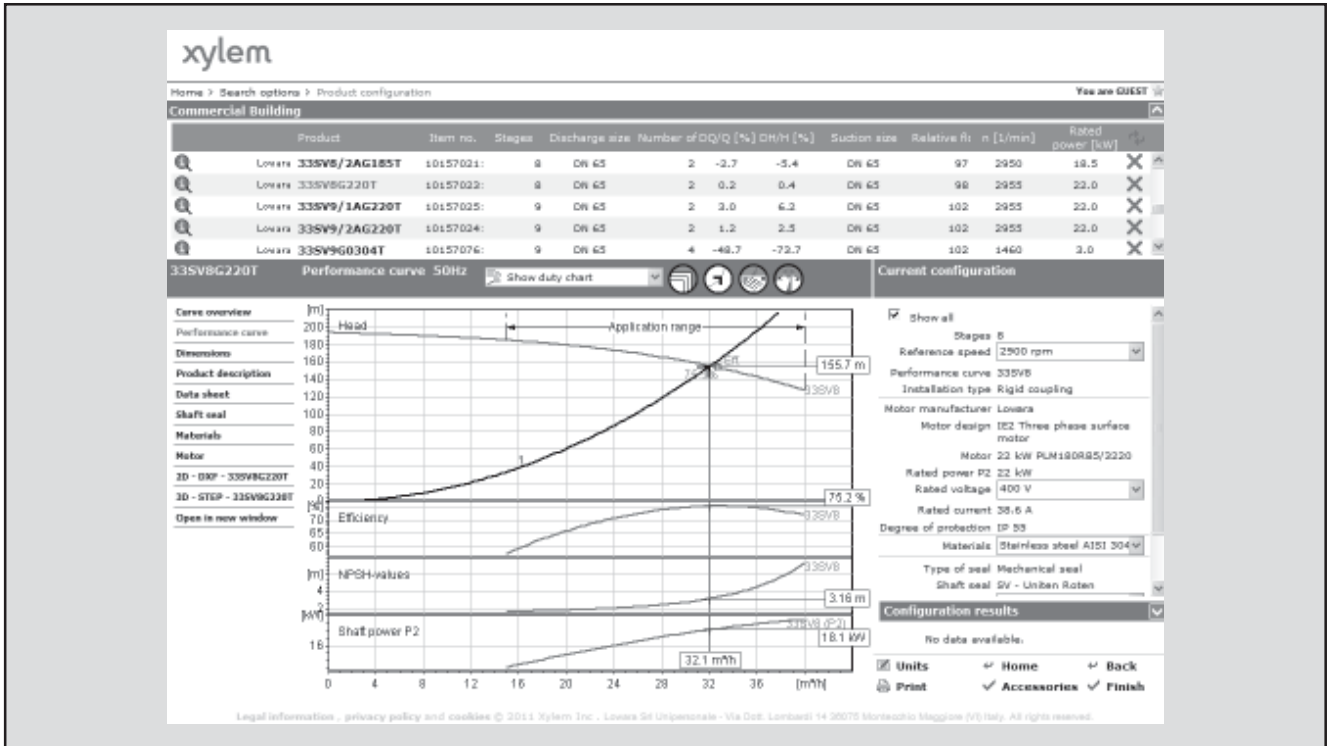

The detailed output makes it easy to select the optimal pump from the given alternatives.

The best way to work with Xylect™ is to create a personal account. This makes it possible to:

- Set own standard units
- Create and save projects
- Share projects with other Xylect™ users

Every user has a My Xylect space, where all projects are saved.

For more information about Xylect™ please contact our sales network or visit www.xylect.com.

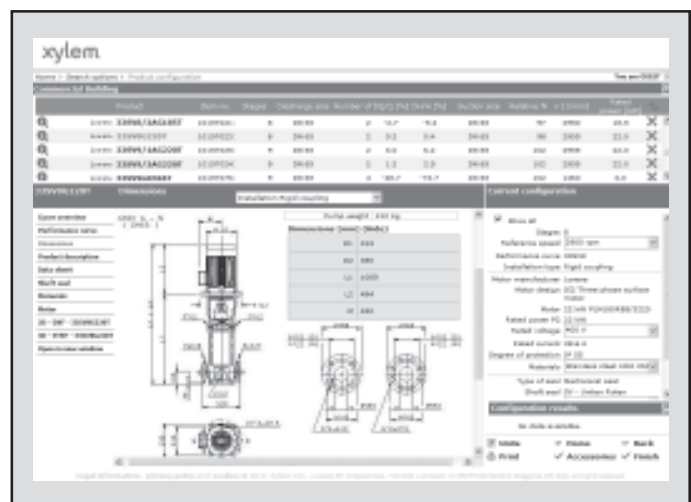

Dimensional drawings appear on the screen and can be downloaded in dxf format.

Xylem |'zīləm|

- 1) The tissue in plants that brings water upward from the roots;
- 2) a leading global water technology company.

We're approximately 12,700 people unified in a common purpose: creating innovative solutions to meet our world's water needs. Developing new technologies that will improve the way water is used, conserved, and re-used in the future is central to our work. We move, treat, analyze, and return water to the environment, and we help people use water efficiently, in their homes, buildings, factories and farms. In more than 150 countries, we have strong, long-standing relationships with customers who know us for our powerful combination of leading product brands and applications expertise, backed by a legacy of innovation.

For more information on how Xylem can help you, go to xylem.com.



Headquarters

LOWARA S.r.l. Unipersonale
Via Vittorio Lombardi 14
36075 Montecchio Maggiore - Vicenza - Italy
Tel. (+39) 0444 707111 - Fax (+39) 0444 492166
e-mail: lowara.mkt@xylem.com
web: www.lowara.com

LOWARA reserves the right to make modification without prior notice.
© 2013 Xylem, Inc.