

KitchenAid®

BOWL LIFT STAND MIXER INSTRUCTIONS AND RECIPES



1-800-541-6390
Details Inside



FOR THE WAY IT'S MADE.™

Hassle-Free Replacement Warranty



We're so confident the quality of our products meets the exacting standards of KitchenAid that, if your Stand Mixer should fail

within the first year of ownership, KitchenAid will arrange to deliver an identical or comparable replacement to your door free of charge and arrange to have your "failed" Stand Mixer returned to us. Your replacement unit will also be covered by our one year full warranty. Please follow these instructions to receive this quality service.

If you reside in the 50 United States and your KitchenAid® Stand Mixer should fail within the first year of ownership, simply call our toll-free Customer Satisfaction Center at **1-800-541-6390**, 8 a.m. to 8 p.m., Monday through Friday, 10 a.m. to 5 p.m., Saturday, Eastern Time. Give the consultant your complete shipping address. (No P.O. Box Numbers, please.)

When you receive your replacement Stand Mixer, use the carton and packing materials to pack-up your "failed" Stand Mixer. In the carton, include your name and address on a sheet of paper along with a copy of the proof of purchase (register receipt, credit card charge slip, etc.).

For a detailed explanation of warranty terms and conditions, including how to arrange for service outside the United States, see pages 3 and 4.

Proof of Purchase & Product Registration

Always keep a copy of the sales receipt showing the date of purchase of your Stand Mixer. Proof of purchase will assure you of in-warranty service.

Before you use your Stand Mixer, please fill out and mail your product registration card packed with the unit. This card will enable us to

contact you in the unlikely event of a product safety notification and assist us in complying with the provisions of the Consumer Product Safety Act. This card does not verify your warranty.

Please complete the following for your personal records:

Model Number _____

Serial Number _____

Date Purchased _____

Store Name _____

Table of Contents

Hassle-Free Replacement Warranty.....	Inside Front Cover
Product Registration Card	Inside Front Cover
Important Safeguards.....	2
Warranty	3
For the 50 United States and District of Columbia.....	3
For Puerto Rico	4
Arranging for Service after the Warranty Expires	4
Arranging for Service Outside the 50 United States and Puerto Rico	4
Ordering Accessories and Replacement Parts	4
Electrical Requirements.....	5
Troubleshooting Problems	5
About Your Mixer	
Bowl Lift Stand Mixer Features.....	6
Assembling Your Bowl Lift Mixer	7
Assembling Your Pouring Shield	8
Using Your KitchenAid® Attachments	9
Mixing Time	9
Mixer Use	9
Care and Cleaning	10
Beater to Bowl Clearance.....	10
Speed Control Guide - 10 Speed Mixers	11
Mixing Tips.....	12
Egg Whites	13
Whipped Cream.....	13
Attachments and Accessories - General Instructions	14
Appetizers, Entrees, and Vegetables	15
Cakes and Frostings.....	25
Cookies, Bars, and Candies	38
Pies and Desserts	48
Yeast Breads and Quick Breads.....	53
General Instructions for Mixing and Kneading Yeast Dough.....	53
Bread Making Tips	54
KitchenAid® Attachments and Accessories	78

Your safety and the safety of others are very important.

We have provided many important safety messages in this manual and on your appliance. Always read and obey all safety messages.



This is the safety alert symbol.

This symbol alerts you to potential hazards that can kill or hurt you and others.

All safety messages will follow the safety alert symbol and either the word "DANGER" or "WARNING." These words mean:

 **DANGER**

You can be killed or seriously injured if you don't immediately follow instructions.

 **WARNING**

You can be killed or seriously injured if you don't follow instructions.

All safety messages will tell you what the potential hazard is, tell you how to reduce the chance of injury, and tell you what can happen if the instructions are not followed.

IMPORTANT SAFEGUARDS

When using electrical appliances, basic safety precautions should always be followed including the following:

1. Read all instructions
2. To protect against risk of electrical shock, do not put Stand Mixer in water or other liquid.
3. Close supervision is necessary when any appliance is used by or near children.
4. Unplug Stand Mixer from outlet when not in use, before putting on or taking off parts and before cleaning.
5. Avoid contacting moving parts. Keep hands, hair, clothing, as well as spatulas and other utensils away from beater during operation to reduce the risk of injury to persons and/or damage to the Stand Mixer.
6. Do not operate Stand Mixer with a damaged cord or plug or after the Stand Mixer malfunctions, or is dropped or damaged in any manner. Return appliance to the nearest authorized service center for examination, repair or electrical or mechanical adjustment. Call the KitchenAid Customer Satisfaction Center at 1-800-541-6390 for more information.
7. The use of attachments not recommended or sold by KitchenAid may cause fire, electrical shock or injury.
8. Do not use the Stand Mixer outdoors.
9. Do not let the cord hang over edge of table or counter.
10. Remove flat beater, wire whip or dough hook from Stand Mixer before washing.
11. This product is designed for household use only.

SAVE THESE INSTRUCTIONS

KitchenAid® Stand Mixer Warranty for the 50 United States and District of Columbia

This warranty extends to the purchaser and any succeeding owner for Stand Mixers operated in the 50 United States and District of Columbia.

Length of Warranty:	KitchenAid Will Pay For Your Choice of:	KitchenAid Will Not Pay For:
<p>One Year Full Warranty from date of purchase.</p>	<div style="text-align: center;">  </div> <p>Hassle-Free Replacement of your Stand Mixer. See inside front cover for details on how to arrange for service, or call the Customer Satisfaction Center toll-free at 1-800-541-6390.</p> <p style="text-align: center;">OR</p> <p>The replacement parts and repair labor costs to correct defects in materials and workmanship. Service must be provided by an Authorized KitchenAid Service Center. See the KitchenAid® Stand Mixer Warranty for Puerto Rico on page 4 for details on how to arrange for service.</p>	<p>A. Repairs when Stand Mixer is used in other than normal single family home use.</p> <p>B. Damage resulting from accident, alteration, misuse or abuse.</p> <p>C. Any shipping or handling costs to deliver your Stand Mixer to an Authorized Service Center.</p> <p>D. Replacement parts or repair labor costs for Stand Mixers operated outside the 50 United States and District of Columbia.</p>

KITCHENAID DOES NOT ASSUME ANY RESPONSIBILITY FOR INCIDENTAL OR CONSEQUENTIAL DAMAGES. Some states do not allow the exclusion or limitation of incidental or consequential damages, so this exclusion may not apply to you. This warranty gives you specific legal rights and you may also have other rights which vary from state to state.

KitchenAid® Stand Mixer Warranty for Puerto Rico

A limited one year warranty extends to the purchaser and any succeeding owner for Stand Mixers operated in Puerto Rico. During the warranty period, all service must be handled by an Authorized KitchenAid Service Center. Please bring the Stand Mixer,

or ship it prepaid and insured, to the nearest Authorized Service Center. Call toll-free **1-800-541-6390** to learn the location of a Service Center near you. Your repaired Stand Mixer will be returned to you prepaid and insured.

Arranging for Service after the Warranty Expires

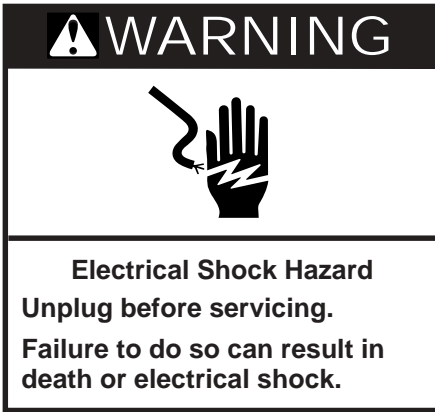

For service information, call toll-free **1-800-541-6390** or write to: Customer Satisfaction Center, KitchenAid Portable Appliances, P.O. Box 218, St. Joseph, MI 49085-0218.

Arranging for Service Outside the 50 United States and Puerto Rico

Consult your local KitchenAid dealer or the store where you purchased the

Stand Mixer for information on how to obtain service.

Ordering Accessories and Replacement Parts

To order accessories or replacement parts for your Stand Mixer, call toll-free **1-800-541-6390** or write to:

Customer Satisfaction Center,
KitchenAid Portable Appliances, P.O.
Box 218, St. Joseph, MI 49085-0218.

Electrical Requirements

Volts: 120 A.C. only. Hertz: 60
The wattage rating for your Stand Mixer is printed on the serial plate.

Do not use an extension cord. If the power supply cord is too short, have a qualified electrician or serviceman install an outlet near the appliance.

⚠️ WARNING



Electrical Shock Hazard

Plug into a grounded 3 prong outlet.

Do not remove ground prong.

Do not use an adapter.

Do not use an extension cord.

Failure to follow these instructions can result in death, fire, or electrical shock.

Troubleshooting Problems

Please read the following before calling your service center.

1. The Stand Mixer may warm up during use. Under heavy loads with extended mixing time periods, you may not be able to comfortably touch the top of the unit. This is normal.
2. The Stand Mixer may emit a pungent odor, especially when new. This is common with electric motors.
3. If the flat beater hits the bowl, stop the Stand Mixer. See "Beater to Bowl Clearance," page 10.

Keep a copy of the sales receipt showing the date of purchase. Proof of purchase will assure you of in-warranty service.

If your Stand Mixer should malfunction or fail to operate, please check the following:

- Is the Stand Mixer plugged in?
- Is the fuse in the circuit to the Stand Mixer in working order? If you have a circuit breaker box, be sure the circuit is closed.
- Turn the Stand Mixer off for 10-15 seconds, then turn it back on. If the mixer still does not start, allow it to cool for 30 minutes before turning it back on.
- If the problem is not due to one of the above items, see "Arranging for Service" on page 4.
- Do not return the Stand Mixer to the retailer as they do not provide service.

Bowl Lift Stand Mixer Features

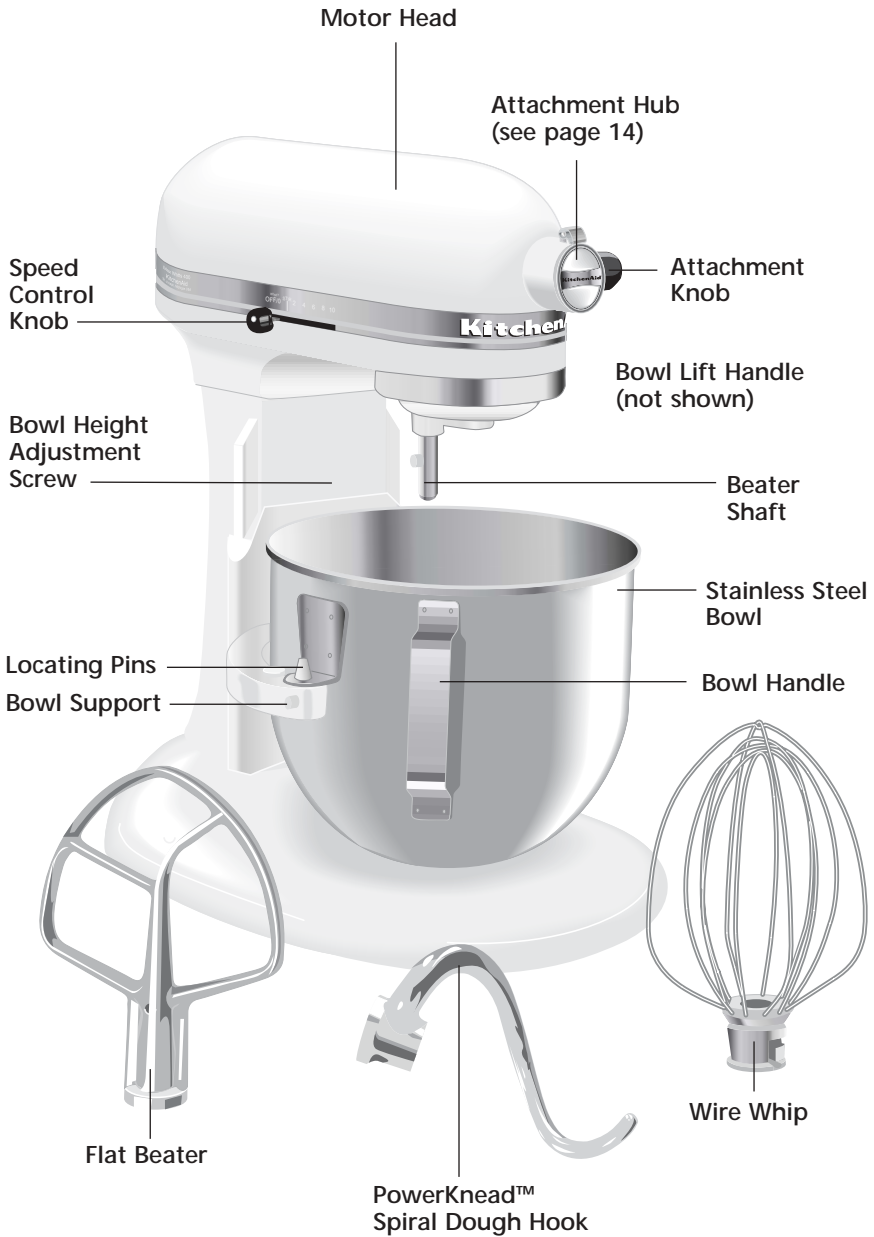

Assembling Your Bowl Lift Mixer

To Attach Bowl

1. Be sure speed control is OFF and Stand Mixer is unplugged.
2. Place bowl lift handle in down position.
3. Fit bowl supports over locating pins.
4. Press down on back of bowl until bowl pin snaps into spring latch.
5. Raise bowl before mixing.
6. Plug into a grounded 3 prong outlet.

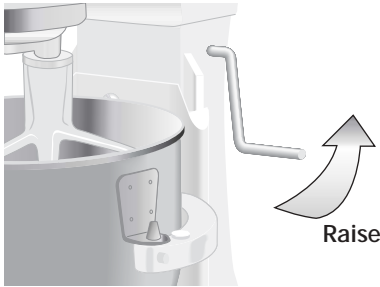

To Raise Bowl

1. Rotate handle to straight-up position.
2. Bowl must always be in raised, locked position when mixing.

To Lower Bowl

1. Rotate handle back and down.

To Remove Bowl

1. Be sure speed control is OFF and Stand Mixer is unplugged.
2. Place bowl lift handle in down position
3. Remove flat beater, wire whip, or spiral dough hook.
4. Grasp bowl handle and lift straight up and off locating pins.

To Attach Flat Beater, Wire Whip, or PowerKnead™ Spiral Dough Hook

1. Slide speed control to OFF and unplug.
2. Slip flat beater on beater shaft.

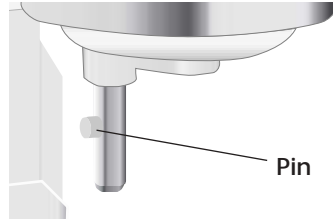

3. Turn beater to left, hooking beater over the pin on shaft.
4. Plug into a grounded 3 prong outlet.

To Remove Flat Beater, Wire Whip, or PowerKnead™ Spiral Dough Hook

1. Slide speed control to OFF and unplug.
2. Press beater upward and turn right.
3. Pull beater from beater shaft.

Household Stand Mixer Speed Control



Plug into a grounded 3 prong outlet. Speed control lever should always be set on lowest speed for starting, then gradually moved to desired higher speed to avoid splashing ingredients out of bowl. See page 11 for Speed Control Guide.

Auto-Reset Motor Protection

If the Stand Mixer stops due to overload, slide the speed control lever to OFF. After a few minutes, the stand mixer will automatically reset. Slide the Speed Control Lever to the desired speed and continue mixing. If the unit does not restart, see "Troubleshooting Problems" on page 5.

Assembling Your Pouring Shield*

To Attach Wide Mouth Pouring Shield (fits all 6-quart and KV 5-quart bowl-lift models)

1. Be sure speed control is OFF and Stand Mixer is unplugged.
2. Place bowl lift handle in down position.
3. Attach desired accessory (flat beater, PowerKnead™ Spiral Dough Hook or wire whip) and bowl.
4. Place bowl lift handle in up position.
5. Slide pouring shield collar around beater shaft, centering collar over rim of bowl. Then, rotate opening in collar toward front of Stand Mixer.

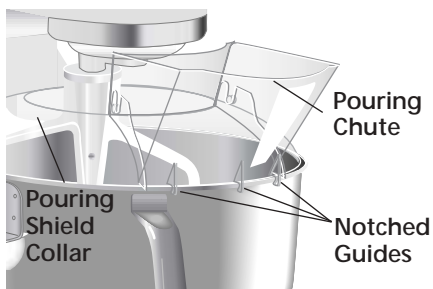

6. Fit tabs on the side of pouring chute into notches on the collar.
7. Fit the three notched guides on bottom of chute along rim of bowl.

To Remove Wide Mouth Pouring Shield

1. Be sure speed control is OFF and Stand Mixer is unplugged.
2. Remove pouring chute from collar.
3. Slide pouring shield collar off bowl.
4. Place bowl lift handle in down position and remove accessory and bowl.

To Use Pouring Shield

1. Pour ingredients into bowl through pouring chute.
2. Important: when using the Wide Mouth Pouring Shield make sure the guides on the bottom of the chute rest on the rim of the bowl to keep ingredients from falling outside the bowl as they are added.

To Attach Pouring Shield (fits all 5-quart bowl-lift models except the 5-quart KV models)

1. Be sure speed control is OFF and Stand Mixer is unplugged.
2. Place bowl lift handle in down position.
3. Attach desired accessory (flat beater, PowerKnead™ Spiral Dough Hook or wire whip) and bowl.
4. Place bowl lift handle in up position.
5. Place the back half of the shield (without the chute) on rim of the bowl.

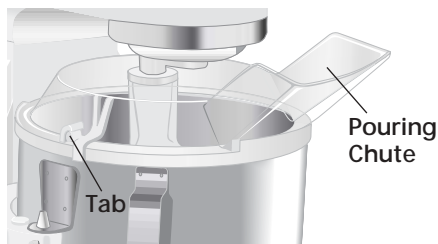

6. Insert the tabs on the front half of the shield (with the chute) under the tab openings on the back half of the shield, then lower the shield to lock into place.

To Remove Pouring Shield

1. Be sure speed control is OFF and Stand Mixer is unplugged.
2. Lift pouring chute from bowl.
3. Slide back half of the shield off bowl.
4. Place bowl lift handle in down position and remove accessory and bowl.

To Use Pouring Shield

1. Pour ingredients into bowl through pouring chute.

* If Pouring Shield is included.

Using Your KitchenAid® Attachments

Flat Beater for normal to heavy mixtures:

cakes	biscuits
creamed frostings	quick breads
candies	meat loaf
cookies	mashed potatoes
pie pastry	

Wire Whip for mixtures that need air incorporated:

eggs	sponge cakes
egg whites	angel food cakes
heavy cream	mayonnaise
boiled frostings	some candies

PowerKnead™ Spiral Dough Hook for mixing and kneading yeast doughs:

bread	coffee cakes
rolls	buns
pizza dough	

Mixing Time

Your KitchenAid® Stand Mixer will mix faster and more thoroughly than most other electric Stand Mixers. Therefore, the mixing time in most

recipes must be adjusted to avoid overbeating. With cakes, for example, beating time may be half as long as with other Stand Mixers.

Mixer Use

WARNING

Injury Hazard

Unplug mixer before touching beaters.

Failure to do so can result in broken bones, cuts or bruises.

The Stand Mixer may warm up during use. Under heavy loads with extended mixing time, you may not be able to comfortably touch the top of the unit. This is normal.

NOTE: Do not scrape bowl while Stand Mixer is operating.

The bowl and beater are designed to provide thorough mixing without frequent scraping. Scraping the bowl once or twice during mixing is usually sufficient. Turn unit off before scraping.

Care and Cleaning

Bowl, white flat beater and white spiral dough hook may be washed in an automatic dishwasher. Or, clean them thoroughly in hot sudsy water and rinse completely before drying. Wire whip, burnished spiral dough hook and burnished flat beater should be hand washed and dried immediately. Do not wash wire whip, burnished spiral dough hook and burnished flat beater in a dishwasher. Do not store beaters on shaft.

NOTE: Always be sure to unplug Stand Mixer before cleaning. Wipe Stand Mixer with a soft, damp cloth. Do not use household/commercial cleaners. Do not immerse in water. Wipe off beater shaft frequently, removing any residue that may accumulate.

Beater to Bowl Clearance

Your Stand Mixer is adjusted at the factory so the flat beater just clears the bottom of the bowl. If, for any reason, the flat beater hits the bottom of the bowl or is too far away from the bowl, you can correct the clearance easily.

1. Unplug Stand Mixer.
2. Place bowl lift handle in down position.
3. Attach flat beater.
4. Adjust so flat beater just clears bottom surface of bowl when in lifted position by turning screw (A) clockwise to raise the bowl and counterclockwise to lower the bowl. Just a slight turn is all that is required: the screw will not rotate more than $\frac{1}{4}$ turn (90 degrees) in either direction. (The full range of adjustment is $\frac{1}{2}$ turn, or 180 degrees.)
5. Place bowl lift handle in up position to check clearance.
6. Repeat steps 4 and 5 if necessary.

NOTE: When properly adjusted, the flat beater will not strike on the bottom or side of the bowl. If the flat beater or the wire whip is so close that it strikes the bottom of the bowl, coating may wear off the beater or wires on whip may wear.

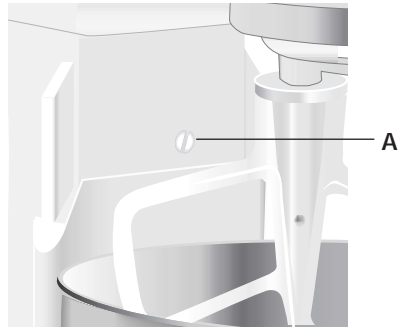

Speed Control Guide – 10 Speed Mixers

All speeds have the Soft Start™ feature which automatically starts the Stand Mixer at a lower speed to help prevent ingredient splash-out and “flour puff” at startup then quickly increases to the selected speed for optimal performance.

Number of Speed

Stir

Speed	STIR	For slow stirring, combining, mashing, starting all mixing procedures. Use to add flour and dry ingredients to batter, and add liquids to dry ingredients. Do not use STIR speed to mix or knead yeast doughs.
2	SLOW MIXING	For slow mixing, mashing, faster stirring. Use to mix and knead yeast doughs, heavy batters and candies, start mashing potatoes or other vegetables, cut shortening into flour, mix thin or splashy batters. Use with Can Opener attachment.
4	MIXING, BEATING	For mixing semi-heavy batters, such as cookies. Use to combine sugar and shortening and to add sugar to egg whites for meringues. Medium speed for cake mixes. Use with: Food Grinder, Rotor Slicer/Shredder, Pasta Roller, and Fruit/Vegetable Strainer.
6	BEATING, CREAMING	For medium fast beating (creaming) or whipping. Use to finish mixing cake, doughnut, and other batters. High speed for cake mixes. Use with Citrus Juicer attachment.
8	FAST BEATING, WHIPPING	For whipping cream, egg whites, and boiled frostings.
10	FAST WHIPPING	For whipping small amounts of cream, egg whites or for final whipping of mashed potatoes. Use with Pasta Maker and Grain Mill attachments. NOTE: Will not maintain fast speeds under heavy loads, such as when using Pasta Maker or Grain Mill attachments.

Use Speed 2 to mix or knead yeast doughs. Use of any other speed creates high potential for unit failure. The PowerKnead™ Spiral Dough Hook efficiently kneads most yeast dough within 4 minutes.

Mixing Tips

Converting Your Recipe for the Mixer

The mixing instructions for recipes in this book can guide you in converting your own favorite recipes for preparation with your KitchenAid® Stand Mixer. Look for recipes similar to yours and then adapt your recipes to use the procedures in the similar KitchenAid® recipes.

For example, the “quick mix” method (sometimes referred to as the “dump” method) is ideal for simple cakes, such as the Quick Yellow Cake and Easy White Cake included in this book. This method calls for combining dry ingredients with most or all liquid ingredients in one step.

More elaborate cakes, such as Caramel Walnut Banana Torte, should be prepared using the traditional cake mixing method. With this method, sugar and the shortening, butter or margarine are thoroughly mixed (creamed) before other ingredients are added.

For all cakes, mixing times may change because your KitchenAid® Stand Mixer works more quickly than other mixers. In general, mixing a cake with the KitchenAid® Stand Mixer will take about half the time called for in most cake recipes.

To help determine the ideal mixing time, observe the batter or dough and mix only until it has the desired appearance described in your recipe, such as “smooth and creamy.”

To select the best mixing speeds, use the Speed Control Guide on pages 11 and 13.

Adding Ingredients

Always add ingredients as close to side of bowl as possible, not directly into moving beater. The Pouring Shield can be used to simplify adding ingredients.

NOTE: If ingredients in very bottom of bowl are not thoroughly mixed, then the beater is not far enough into the bowl. See “Beater to Bowl Clearance,” page 10.

Cake Mixes

When preparing packaged cake mixes, use Speed 2 for low speed, Speed 4 for medium speed, and Speed 6 for high speed. For best results, mix for the time stated on the package directions.

Adding Nuts, Raisins, or Candied Fruits

Follow individual recipes for guidelines on including these ingredients. In general, solid materials should be folded in the last few seconds of mixing on STIR Speed. The batter should be thick enough to prevent the fruit or nuts from sinking to the bottom of the pan during baking. Sticky fruits should be dusted with flour for better distribution in the batter.

Liquid Mixtures

Mixtures containing large amounts of liquid ingredients should be mixed at lower speeds to avoid splashing. Increase speed only after mixture has thickened.

Egg Whites

Place room temperature egg whites in clean, dry bowl. Attach bowl and wire whip. To avoid splashing, gradually turn to designated speed and whip to desired stage. See chart below.

AMOUNT	SPEED
1 egg white	GRADUALLY to 10
2-4 egg whites	GRADUALLY to 8
6 or more egg whites	GRADUALLY to 8

Whipping Stages

With your KitchenAid® Stand Mixer, egg whites whip quickly. So, watch carefully to avoid overwhipping. This list tells you what to expect.

Frothy

Large, uneven air bubbles.

Begins to Hold Shape

Air bubbles are fine and compact; product is white.

Soft Peak

Tips of peaks fall over when wire whip is removed.

Almost Stiff

Sharp peaks form when wire whip is removed, but whites are actually soft.

Stiff but not Dry

Sharp, stiff peaks form when wire whip is removed. Whites are uniform in color and glisten.

Stiff and Dry

Sharp, stiff peaks form when wire whip is removed. Whites are speckled and dull in appearance.

Whipped Cream

Pour cold whipping cream into chilled bowl. Attach bowl and wire whip. To avoid splashing, gradually turn to designated speed and whip to desired stage. See chart below.

AMOUNT	SPEED
¼ cup (50 mL).....	GRADUALLY to 10
½ cup (125 mL)	GRADUALLY to 10
1 cup (250 mL).....	GRADUALLY to 8
1 pint (500 mL)	GRADUALLY to 8

Whipping Stages

Watch cream closely during whipping. Because your KitchenAid® Stand Mixer whips so quickly, there are just a few seconds between whipping stages. Look for these characteristics:

Begins to Thicken

Cream is thick and custard-like.

Holds its Shape

Cream forms soft peaks when wire whip is removed. Can be folded into other ingredients when making desserts and sauces.

Stiff

Cream stands in stiff, sharp peaks when wire whip is removed. Use for topping on cakes or desserts, or filling for cream puffs.

Attachments and Accessories

General Information

KitchenAid® Attachments are designed to assure long life. The attachment power shaft and hub socket are of a square design, to eliminate any possibility of slipping during the transmission of power to the attachment. The hub and shaft housing are tapered to assure a snug fit, even after prolonged use and wear. KitchenAid® Attachments require no extra power unit to operate them; the power unit is built-in.

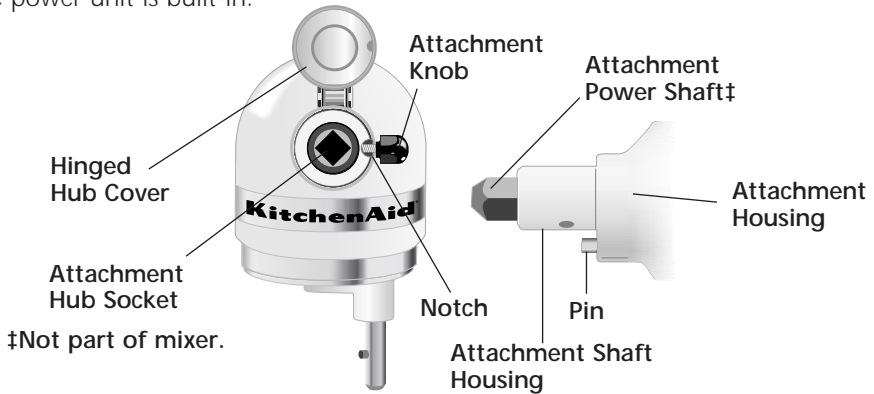

General Instructions

To Attach

1. Turn Stand Mixer off and unplug.
2. Loosen attachment knob by turning it counterclockwise.
3. Flip up hinged hub cover.
4. Insert attachment shaft housing into attachment hub, making certain that attachment power shaft fits into square attachment hub socket. It may be necessary to rotate attachment back and forth. When attachment is in proper position, the pin on the attachment will fit into the notch on the hub rim.
5. Tighten attachment knob by turning clockwise until attachment is completely secured to Stand Mixer.
6. Plug into a grounded 3 prong outlet.

To Remove

1. Turn Stand Mixer off and unplug.
2. Loosen attachment knob by turning it counterclockwise. Rotate attachment slightly back and forth while pulling out.
3. Replace attachment hub cover. Tighten attachment knob by turning it clockwise.

Crabmeat Dip

- 1 package (8 oz.) light cream cheese
- 1 cup reduced-fat cottage cheese
- $\frac{1}{4}$ cup reduced-calorie mayonnaise
- 1 can (6 $\frac{1}{2}$ oz.) crabmeat, flaked
- 1 tablespoon lemon juice
- 3 tablespoons chopped green onions
- $\frac{1}{2}$ teaspoon garlic salt
- 3 drops hot pepper sauce

Place cream cheese, cottage cheese, and mayonnaise in mixer bowl. Attach bowl and flat beater to mixer. Turn to Speed 6 and beat about 1 minute, or until well blended. Stop and scrape bowl. Add all remaining ingredients. Turn to Speed 6 and beat about 1 minute, or until all ingredients are combined.

Refrigerate until well chilled. Serve with assorted crackers or raw vegetables.

Yield: 24 servings (2 tablespoons per serving).

Per serving: About 42 cal, 4 g pro, 1 g carb, 3 g fat, 12 mg chol, 180 mg sod.

Creamy Pineapple Fruit Dip

- 4 ounces light cream cheese
- $\frac{1}{2}$ cup marshmallow cream
- 1 can (8 oz.) crushed pineapple, well drained
- 2 teaspoons grated orange peel

Place cream cheese in mixer bowl. Attach bowl and flat beater to mixer. Turn to Speed 2 and mix about 30 seconds. Stop and scrape bowl. Add marshmallow cream, pineapple, and orange peel. Turn to Speed 4 and beat about 30 seconds. Stop and scrape bowl. Turn to Speed 4 and beat about 30 seconds. Refrigerate at least 2 hours. Serve with sliced fresh fruit, if desired.

Yield: 12 servings (2 tablespoons per serving).

Per serving: About 61 cal, 1 g pro, 11 g carb, 2 g fat, 3 mg chol, 58 mg sod.

Layered Mexican Dip

1 package (8 oz.) light cream cheese

½ cup shredded hot pepper Monterey Jack cheese

¼ cup bean or black bean dip

½ cup thick and chunky salsa

½ cup chopped green onions

¼ cup sliced pitted ripe olives

Place cream cheese in mixer bowl. Attach bowl and flat beater to mixer. Turn to Speed 2 and mix about 30 seconds. Stop and scrape bowl. Add Monterey Jack cheese. Turn to Speed 2 and mix about 30 seconds.

Spread cheese mixture on 10-inch serving plate to within 1 or 2 inches of edge. Spread bean dip over cheese. Spread salsa over bean dip. Top with onions and olives. Refrigerate until ready to serve. Serve with tortilla chips, if desired.

Yield: 12 servings (½ cup per serving).

Per serving: About 70 cal, 4 g pro, 3 g carb, 5 g fat, 12 mg chol, 265 mg sod.

Fiesta Cheesecake Appetizer

2 packages (8 oz. each) light cream cheese, softened

1 package (1.25 oz.) taco seasoning mix

3 eggs

2 cups shredded Marble-Jack cheese

1 can (4 oz.) green chilies

1 cup light sour cream

1 cup salsa

Place cream cheese and taco seasoning mix in mixer bowl. Attach bowl and flat beater to mixer. Turn to Speed 6 and beat about 1½ minutes, or until fluffy. Stop and scrape bowl. Turn to Speed 4 and add eggs, one at a time, beating about 15 seconds after each addition. Stop and scrape bowl. Add cheese and green chilies. Turn to STIR Speed and mix 15 seconds.

Pour mixture into greased 9-inch springform pan. Bake at 350°F for 40 minutes, or until knife inserted near center comes out clean. Remove from oven and spread with sour cream. Return to oven and bake 5 minutes longer. Cool 15 minutes. Refrigerate 3 to 8 hours. Before serving, remove outer ring and spread top of cheesecake with salsa. Serve with taco chips, if desired.

Yield: 20 servings (1 wedge per serving).

Per serving: About 136 cal, 7 g pro, 5 g carb, 9 g fat, 59 mg chol, 421 mg sod.

Nutty Cheese Ball

- 1 cup shredded sharp Cheddar cheese
- 1 cup shredded Swiss cheese
- 1 package (8 oz.) light cream cheese
- 2 tablespoons chopped fresh chives
- 2 teaspoons Worcestershire sauce
- ¼ teaspoon paprika
- ½ teaspoon garlic powder
- ¼ cup finely chopped pecans

Place all ingredients, except pecans, in mixer bowl. Attach bowl and flat beater to mixer. Turn to Speed 4 and beat about 1 minute, or until well blended.

On waxed paper, shape mixture into a ball. Roll ball in chopped pecans. Wrap in waxed paper.

Refrigerate until serving time. Serve with assorted crackers or raw vegetables.

Yield: 24 servings (2 tablespoons per serving).

Per serving: About 65 cal, 4 g pro, 1 g carb, 5 g fat, 13 mg chol, 109 mg sod.

Spinach and Cheese Crostini

- 1 baguette loaf, cut into ½-inch slices
- 2 teaspoons butter or margarine
- ½ cup finely chopped onion
- 1 clove garlic, minced
- 1 package (9 oz.) frozen chopped spinach, thawed and squeezed dry
- 1 package (8 oz.) light cream cheese
- ¼ cup roasted red peppers
- ½ cup shredded Cheddar cheese

Place baguette slices on baking sheet. Bake at 375°F for 4 to 6 minutes, or until toasted. Set aside.

Melt butter in 10-inch skillet over medium heat. Add onion and garlic. Cook and stir 2 to 3 minutes, or until softened. Add spinach. Cook and stir 30 to 60 seconds, or until warm. Cool slightly.

Place cream cheese in mixer bowl. Attach bowl and flat beater to mixer. Turn to Speed 2, mix about 30 seconds. Add spinach mixture. Continuing on Speed 2, mix about 30 seconds. Add red peppers. Continuing on Speed 2, mix about 30 seconds. Spread spinach mixture on toasted baguette slices. Top each slice with about 1 teaspoon Cheddar cheese. Bake at 375°F for 5 to 8 minutes, or until thoroughly heated and cheese is melted. Serve warm.

Yield: 12 servings (2 crostini per serving).

Per serving: About 141 cal, 6 g pro, 16 g carb, 6 g fat, 12 mg chol, 324 mg sod.

Mushroom-Onion Tartlets

Pastry Crusts

- 4 oz. light cream cheese
- 3 tablespoons butter or margarine, divided
- $\frac{3}{4}$ cup plus 1 teaspoon all-purpose flour
- 8 oz. fresh mushrooms, coarsely chopped
- $\frac{1}{2}$ cup chopped green onions

Filling

- 1 egg
- $\frac{1}{4}$ teaspoon dried thyme leaves
- $\frac{1}{2}$ cup shredded Swiss cheese

To make **Pastry Crusts**, place cream cheese and 2 tablespoons butter in mixer bowl. Attach bowl and flat beater to mixer. Turn to Speed 4 and beat about 1 minute. Stop and scrape bowl. Add $\frac{3}{4}$ cup flour. Turn to Speed 2 and mix about 1 minute, or until well blended. Form mixture into a ball. Wrap in waxed paper and chill 1 hour. Clean mixer bowl and beater.

To make **Filling**, melt remaining 1 tablespoon butter in 10-inch skillet over medium heat. Add mushrooms and onions. Cook and stir until tender. Remove from heat. Cool slightly.

Divide chilled dough into 24 pieces. Press each piece into miniature muffin cup (greased, if desired).

For **Filling**, place egg, remaining 1 teaspoon flour, and thyme in mixer bowl. Attach bowl and flat beater to mixer. Turn to Speed 6 and beat about 30 seconds. Stir in cheese and cooled mushroom mixture. Spoon into pastry-lined muffin cups. Bake at 375°F for 15 to 20 minutes, or until egg mixture is puffed and golden brown. Serve warm.

Yield: 12 servings (2 tartlets per serving).

Per serving: About 98 cal, 4 g pro, 8 g carb, 6 g fat, 33 mg chol, 83 mg sod.

Sweet Potato Puff

- 2 medium sweet potatoes, cooked and peeled
- $\frac{1}{2}$ cup low-fat milk
- $\frac{1}{2}$ cup sugar
- 2 eggs
- 2 tablespoons butter or margarine
- $\frac{1}{2}$ teaspoon nutmeg
- $\frac{1}{2}$ teaspoon cinnamon

Place potatoes in mixer bowl. Attach bowl and flat beater to mixer. Turn to Speed 2 and mix about 30 seconds. Add milk, sugar, eggs, 2 tablespoons butter, nutmeg, and cinnamon. Turn to Speed 4 and beat about 1 minute. Spread mixture in greased 9-inch pie plate. Bake at 400°F for 20 minutes, or until set. Clean bowl and beater.

Place all **Topping** ingredients in mixer bowl. Attach bowl and flat beater to mixer. Turn to STIR Speed and mix about 15 seconds. Spread on hot puff. Bake 10 minutes longer.

Yield: 6 servings ($\frac{1}{2}$ cup per serving).

Per serving: About 268 cal, 6 g pro, 35 g carb, 12 g fat, 2 mg chol, 176 mg sod.

Crunchy Praline

Topping

- 2 tablespoons butter or margarine, melted
- $\frac{3}{4}$ cup corn flakes
- $\frac{1}{4}$ cup chopped walnuts or pecans
- $\frac{1}{4}$ cup firmly packed brown sugar

Herbed Whipped Squash

- 1 large butternut squash, baked (about 3 cups cooked)
- $\frac{1}{4}$ cup butter or margarine, melted
- $\frac{1}{2}$ teaspoon dried tarragon leaves
- $\frac{1}{8}$ teaspoon salt
- $\frac{1}{8}$ teaspoon black pepper

Scoop cooked squash out of shell and place in mixer bowl. Attach bowl and wire whip to mixer. Turn to Speed 4 and beat about 30 seconds. Add all remaining ingredients. Turn to Speed 2 and mix about 30 seconds. Turn to Speed 4 and beat about 2 minutes.

Yield: 6 servings ($\frac{1}{2}$ cup per serving).

Per serving: About 107 cal, 1 g pro, 11 g carb, 7 g fat, 0 mg chol, 137 mg sod.

Appetizer Cream Puffs with Creamy Feta Olive Filling

Cream Puffs

- 1 cup water
- ½ cup butter or margarine
- ¼ teaspoon salt
- 1 cup all-purpose flour
- 4 eggs

Filling

- 1 package (8 oz.) light cream cheese
- 4 oz. crumbled tomato-basil feta cheese
- ½ cup light sour cream
- ½ cup finely chopped kalamata or ripe olives
- ½ teaspoon lemon pepper seasoning

To make **Cream Puffs**, heat water, butter, and salt in a medium saucepan over high heat to a full rolling boil. Reduce heat and quickly stir in flour, mixing vigorously until mixture leaves sides of pan in a ball.

Place flour mixture in mixer bowl. Attach bowl and flat beater. Turn to Speed 2 and add eggs, one at a time, beating about 30 seconds after each addition. Stop and scrape bowl. Turn to Speed 4 and beat about 15 seconds.

Drop dough onto greased baking sheets forming 36 mounds, 2 inches apart. Bake at 400°F for 10 minutes. Reduce heat to 350°F and bake 25 minutes longer. Turn off oven. Remove pans from oven. Cut a small slit in side of each puff. Return pans to oven (turned off) for 10 minutes, leaving oven door ajar. Cool completely on rack.

To make **Filling**, combine all ingredients in mixer bowl. Attach bowl and flat beater. Turn to Speed 2 and mix about 30 seconds, or until blended. Pipe or spoon about 1 tablespoon filling into each cream puff.

Yield: 36 servings (1 filled cream puff per serving).

Per serving: About 72 cal, 2 g pro, 4 g carb, 5 g fat, 37 mg chol, 132 mg sod.

Mashed Potatoes

5 large potatoes (about 2½ lbs.), peeled, quartered, and boiled

½ cup low-fat milk, heated

2 tablespoons butter or margarine

1 teaspoon salt

¼ teaspoon black pepper

Warm mixer bowl and flat beater with hot water; dry. Place hot potatoes in bowl. Attach bowl and flat beater to mixer. Gradually turn to Speed 2 and mix about 1 minute, or until smooth.

Add all remaining ingredients. Turn to Speed 4 and beat about 30 seconds, or until milk is absorbed. Gradually turn to Speed 6 and beat about 1 minute, or until fluffy. Stop and scrape bowl. Exchange flat beater for wire whip. Turn to Speed 10 and whip 2 to 3 minutes.

Yield: 9 servings (¾ cup per serving).

Per serving: About 111 cal, 2 g pro, 19 g carb, 3 g fat, 8 mg chol, 296 mg sod.

VARIATIONS

Garlic Mashed Potatoes

Substitute 1 teaspoon garlic salt for salt.

Per serving: About 111 cal, 2 g pro, 19 g carb, 3 g fat, 8 mg chol, 239 mg sod.

9 large potatoes (about 5 lbs.), peeled, quartered, and boiled

¾ cups low-fat milk, heated

3 tablespoons butter or margarine

1½ teaspoons salt

¼ teaspoon black pepper

Mashed Potatoes for a Crowd

Prepare as directed above, using 6 quart mixer bowl.

Yield: 18 servings (¾ cup per serving).

Garden Quiche

*Baked Pastry Shell
(see page 50)*

- 1 *tablespoon oil*
- 1 *small onion,
chopped*
- 1 *medium green bell
pepper, chopped*
- 8 *oz. sliced fresh
mushrooms*
- 6 *eggs*
- 1/3 *cup low-fat milk*
- 1 *tablespoon chopped
fresh parsley*
- 1 *teaspoon salt*
- 5 *drops hot pepper
sauce*
- 1 *cup (4 oz.) reduced-
fat shredded Swiss
cheese*

Follow procedure for Baked Pastry Shell. Cool 10 minutes.

Meanwhile, heat oil in large non-stick skillet over medium-high heat. Add onion and bell pepper. Cook about 1 minute, stirring frequently. Add mushrooms. Cook and stir about 2 minutes, or until vegetables are tender. Set aside.

Place eggs, milk, parsley, salt, and hot pepper sauce in mixer bowl. Attach bowl and wire whip to mixer. Turn to Speed 2 and mix 1 to 2 minutes.

Sprinkle half of cheese in pastry shell. Top with vegetables. Pour egg mixture over vegetables. Top with remaining cheese. Bake at 350°F for 30 to 35 minutes, or until knife inserted in center comes out clean. Let stand about 5 minutes before serving.

Yield: 8 servings.

Per serving (filling and crust): About 264 cal, 12 g pro, 17 g carb, 16 g fat, 172 mg chol, 561 mg sod.

Mexican Meatloaf

- 1 cup salsa, divided
- 2 cups soft bread crumbs
- 1 small onion, chopped
- 1 egg
- 1 tablespoon Worcestershire sauce
- 1 teaspoon dried thyme
- ½ teaspoon garlic salt
- ¼ teaspoon pepper
- 1 pound lean ground beef
- ½ pound ground turkey

Place $\frac{3}{4}$ cup salsa, bread crumbs, onion, egg, Worcestershire sauce, thyme, garlic salt, and pepper in mixer bowl. Attach bowl and flat beater to mixer. Turn to STIR Speed, mix about 30 seconds. Add beef and turkey. Continuing on STIR Speed, mix about 45 seconds, or until blended.

Divide mixture into 3 equal parts. Shape each part into a loaf about 6x3x12-inches. Place loaves on rack in shallow baking pan. Spoon remaining salsa on tops of loaves. Bake at 350°F for 40 to 45 minutes, or until no longer pink in center.

Yield: 6 servings (2 servings per loaf).

Per serving: About 167 cal, 11 g pro, 16 g carb, 6 g fat, 47 mg chol, 426 mg sod.

VARIATION

Mexican Appetizer Meatballs

Form meat mixture into 1-inch balls. Place in 13x9x2-inch rectangular baking pan. Bake at 400°F for 20 to 25 minutes, or until no longer pink inside. Serve with salsa, if desired.

Yield: 18 servings (2 meatballs per serving).

Per serving: About 124 cal, 9 g pro, 11 g carb, 5 g fat, 36 mg chol, 287 mg sod.

Meatloaf for a Crowd

Double the ingredients and mix in the 6 quart mixer bowl.

Yield: 12 servings ($\frac{1}{2}$ loaf per serving).

Chicken and Mushroom Casserole with Cheese Puff Topping

Filling

- 2 *tablespoons butter or margarine*
- 3 *boneless, skinless chicken breast halves, cut into ½-inch pieces*
- 1 *medium onion or 3 shallots, sliced*
- 8 *ounces button or crimini mushrooms, halved or quartered*
- 1 *can (14½ oz.) diced tomatoes, undrained*
- 2 *tablespoons flour*
- ½ *teaspoon dried thyme leaves*

Pastry Topping

- ½ *cup water*
- ¼ *cup butter or margarine, cut up*
- ¼ *teaspoon salt*
- ½ *cup all-purpose flour*
- 2 *eggs*
- 2 *oz. sharp Cheddar cheese, diced*

To make **Filling**, melt butter in large skillet over medium heat. Add chicken and onion. Cook and stir 3 minutes. Add mushrooms. Cook and stir 5 minutes. Add tomatoes, flour, and thyme. Cook and stir until thickened and bubbly. Cover and keep warm on low heat.

To make **Pastry Topping**, heat water, butter, and salt in small saucepan over high heat to a full rolling boil. Reduce heat and quickly stir in flour, mixing vigorously until mixture leaves sides of pan in a ball.

Place flour mixture in mixer bowl. Attach bowl and flat beater to mixer. Turn to Speed 2 and add eggs, one at a time, mixing about 30 seconds after each addition. Stop and scrape bowl. Turn to Speed 4 and beat about 15 seconds. Add cheese. Turn to STIR Speed and mix about 10 seconds.

Pour hot filling into 2-quart casserole dish sprayed with no-stick cooking spray. Spoon pastry into 4 mounds on top of chicken mixture. Bake at 400°F for 35 to 45 minutes, or until pastry is puffed and browned and filling is bubbly.

Yield: 4 servings.

Per serving: About 507 cal, 39 g pro, 24 g carb, 28 g fat, 240 mg chol, 706 mg sod.

Quick Yellow Cake

- 2¼ cups all-purpose flour*
- 1½ cups sugar*
- 3 teaspoons baking powder*
- ½ teaspoon salt*
- ½ cup shortening*
- 1 cup low-fat milk*
- 1 teaspoon vanilla*
- 2 eggs*

Combine dry ingredients in mixer bowl. Add shortening, milk, and vanilla. Attach bowl and flat beater to mixer. Turn to Speed 2 and mix about 1 minute. Stop and scrape bowl. Add eggs. Continuing on Speed 2, mix about 30 seconds. Stop and scrape bowl. Turn to Speed 6 and beat about 1 minute.

Pour batter into two greased and floured 8- or 9-inch round baking pans. Bake at 350°F for 30 to 35 minutes, or until toothpick inserted in center comes out clean. Cool 10 minutes. Remove from pans. Cool completely on wire rack. Frost if desired.

Yield: 12 to 16 servings.

Per serving: About 272 cal, 4 g pro, 42 g carb, 10 g fat, 37 mg chol, 175 mg sod.

Easy White Cake

- 2 cups all-purpose flour*
- 1½ cups sugar*
- 3 teaspoons baking powder*
- ½ teaspoon salt*
- ½ cup shortening*
- 1 cup low-fat milk*
- 1 teaspoon vanilla*
- 4 egg whites*

Combine dry ingredients in mixer bowl. Add shortening, milk, and vanilla. Attach bowl and flat beater to mixer. Turn to Speed 2 and mix about 1 minute. Stop and scrape bowl. Add egg whites. Turn to Speed 6 and beat about 1 minute, or until smooth and fluffy.

Pour batter into two greased and floured 8- or 9-inch round baking pans. Bake at 350°F for 30 to 35 minutes, or until toothpick inserted in center comes out clean. Cool 10 minutes. Remove from pans. Cool completely on wire rack. Frost if desired.

Yield: 12 to 16 servings.

Per serving: About 267 cal, 4 g pro, 42 g carb, 9 g fat, 2 mg chol, 183 mg sod.

Caramel Walnut Banana Torte

Topping

- 1 cup firmly packed brown sugar
- ½ cup butter or margarine
- ¼ cup whipping cream
- 1 cup chopped walnuts

To make **Topping**, place brown sugar, butter, and cream in small saucepan. Heat over low heat just until butter melts, stirring constantly. Pour over bottoms of three 8- or 9-inch round baking pans. Sprinkle with walnuts.

Cake

- 1½ cups sugar
- ½ cup butter or margarine, softened
- 1 cup (2 medium) mashed ripe banana
- 1 teaspoon vanilla
- 3 eggs
- 2½ cups all-purpose flour
- 1¼ teaspoons baking powder
- 1 teaspoon baking soda
- ½ teaspoon salt
- ¾ cup buttermilk

To make **Cake**, place sugar and butter in mixer bowl. Attach bowl and flat beater to mixer. Turn to Speed 2 and mix about 30 seconds. Stop and scrape bowl. Add banana and vanilla. Continuing on Speed 2, mix about 30 seconds. Continuing on Speed 2, add eggs, one at a time, mixing about 15 seconds after each addition. Stop and scrape bowl.

Combine flour, baking powder, baking soda, and salt in small bowl. Add half of flour mixture to sugar mixture in mixer bowl. Turn to Speed 2 and mix about 30 seconds. Add buttermilk and remaining flour mixture. Gradually turn to Speed 6 and beat about 30 seconds. Spread batter evenly over nut mixture in pans. Bake at 350°F for 25 to 30 minutes, or until toothpick inserted in center comes out clean. Cool in pans about 3 minutes. Remove from pans and cool completely on wire racks.

Filling

- ½ cup sugar
- 3 tablespoons all-purpose flour
- ¼ teaspoon salt
- 1 cup low-fat milk
- 1 egg, beaten
- 1 teaspoon vanilla
- 1 tablespoons butter or margarine
- 2 medium bananas, thinly sliced
- ½ cup whipping cream, whipped

Meanwhile, to make **Filling**, combine sugar, flour, and salt in medium saucepan. Gradually stir in milk. Heat to boiling over medium heat, stirring constantly. Stir about ¼ cup hot mixture into beaten egg in separate bowl. Pour egg mixture into saucepan. Cook until mixture is bubbly, stirring constantly. Remove from heat. Stir in vanilla and butter. Cool slightly. Refrigerate 1 hour while cake is cooling.

To assemble torte, place one cake layer, nut side up, on large plate. Spread with half of **Filling**. Arrange half of banana slices over **Filling**. Top with second layer, nut side up. Spread with remaining **Filling** and banana slices. Top with remaining cake layer, nut side up. Top torte with whipped cream. Store in refrigerator.

Yield: 16 to 20 servings.

Per serving: About 451 cal, 7 g pro, 65 g carb, 19 g fat, 58 mg chol, 384 mg sod.

Angel Food Cake

1/4 cups all-purpose flour
1 1/2 cups sugar, divided
1 1/2 cups egg whites (about 12 to 15 egg whites)
1 1/2 teaspoons cream of tartar
1/4 teaspoon salt
1 1/2 teaspoons vanilla or 1/2 teaspoon almond extract

Mix flour and 1/2 cup sugar in small bowl. Set aside.

Place egg whites in mixer bowl. Attach bowl and wire whip to mixer. Gradually turn to Speed 6 and whip 30 to 60 seconds, or until egg whites are frothy.

Add cream of tartar, salt, and vanilla. Turn to Speed 8 and whip 2 to 2 1/2 minutes, or until whites are almost stiff but not dry. Turn to Speed 2. Gradually add remaining 1 cup sugar and mix about 1 minute. Stop and scrape bowl.

Remove bowl from mixer. Spoon flour-sugar mixture, one-fourth at a time, over egg whites. Fold in gently with spatula, just until blended.

Pour batter into ungreased 10-inch tube pan. With knife, gently cut through batter to remove large air bubbles. Bake at 375°F for 35 minutes, or until crust is golden brown and cracks are very dry. Immediately invert cake onto funnel or soft drink bottle. Cool completely. Remove from pan.

Yield: 16 servings.

Per serving: About 124 cal, 4 g pro, 27 g carb, 0 g fat, 0 mg chol, 79 mg sod.

Old-Fashioned Pound Cake

- 3 cups all-purpose flour
- 2 cups sugar
- 3 teaspoons baking powder
- ½ teaspoon salt
- 2 cups butter, softened
- ½ cup low-fat milk
- 1 teaspoon vanilla
- 1 teaspoon almond extract
- 6 eggs

Combine dry ingredients in mixer bowl. Add butter, milk, vanilla, and almond extract. Attach bowl and flat beater to mixer. Turn to STIR Speed and mix about 1 minute. Stop and scrape bowl. Turn to Speed 6 and beat about 2 minutes. Stop and scrape bowl.

Turn to Speed 2 and add eggs, one at a time, mixing about 15 seconds after each addition. Turn to Speed 4 and beat about 30 seconds.

Pour batter into greased and floured 10-inch tube pan. Bake at 350°F for 1 hour 15 minutes, or until toothpick inserted in center comes out clean. Cool completely on wire rack. Remove cake from pan.

Yield: 16 servings.

Per serving: About 419 cal, 5 g pro, 44 g carb, 25 g fat, 143 mg chol, 378 mg sod.

VARIATION

Double Chocolate Pound Cake

Add ½ cup unsweetened Dutch-processed cocoa powder to dry ingredients. Reduce butter to 1 cup. Increase milk to 1 cup. Omit almond extract. Prepare as directed above. Bake at 325°F for 1 hour 20 minutes.

Chocolate Glaze

Melt 1 square (1 oz.) semi-sweet chocolate and 1 teaspoon shortening in small saucepan over low heat, stirring to blend. Drizzle over cake.

Yield: 16 servings.

Per serving (cake and glaze): About 390 cal, 6 g pro, 55 g carb, 18 g fat, 99 mg chol, 289 mg sod.

Italian Cream Cake

- 5 eggs, separated
- ½ cup butter or margarine
- ½ cup shortening
- 1¾ cup sugar
- 2 cups all-purpose flour
- 1 teaspoon baking soda
- 1 cup buttermilk
- 1 teaspoon vanilla
- 2 cups coconut
- 1 cup chopped pecans

Place egg whites in mixer bowl. Attach bowl and wire whip to mixer. Turn to Speed 8 and whip 2½ to 3 minutes, or until egg whites are stiff but not dry. Place egg whites in another bowl.

Place butter, shortening, and sugar in mixer bowl. Attach bowl and flat beater to mixer. Turn to Speed 4 and mix about 2½ minutes, or until light and fluffy. Continuing on Speed 4, add egg yolks, one at a time, mixing about 15 seconds after each addition. Stop and scrape bowl.

Mix flour and baking soda. Add half to sugar mixture in mixer bowl. Turn to Speed 2 and mix about 30 seconds. Add buttermilk, vanilla, and remaining flour mixture. Gradually turn to Speed 4 and beat about 1 minute.

Add coconut and pecans. Turn to STIR Speed and mix just until blended. Remove bowl from mixer. Gently fold in beaten egg whites with spatula just until blended. Pour batter into greased and floured 13x9x2-inch baking pan. Bake at 350°F for 40 to 50 minutes, or until toothpick inserted in center comes out clean. Cool completely on wire rack. Spread with Cream Cheese Frosting.

Yield: 15 servings.

Note: For best flavor, chill cake in refrigerator several hours or overnight.

Cream Cheese Frosting

- 4 cups powdered sugar
- 1 package (8 oz.) light cream cheese, softened
- ½ cup butter or margarine, softened
- 1 teaspoon vanilla

Place all ingredients in mixer bowl. Attach bowl and flat beater to mixer. Turn to Speed 2 and mix about 30 seconds, or until blended. Stop and scrape bowl. Turn to Speed 4 and beat about 2 minutes, or until smooth and creamy. Spread on cooled cake.

Per serving: About 626 cal, 7 g pro, 77 g carb, 33 g fat, 112 mg chol, 351 mg sod.

Chocolate Cake

- 2 cups all-purpose flour
- 1½ cups sugar
- 1 teaspoon baking powder
- ½ teaspoon baking soda
- ½ teaspoon salt
- ½ cup shortening
- 1 cup low-fat milk
- 1 teaspoon vanilla
- 2 eggs
- 2 squares (1 oz. each) unsweetened chocolate, melted

Combine dry ingredients in mixer bowl. Add shortening, milk, and vanilla. Attach bowl and flat beater to mixer. Turn to Speed 2 and mix about 1 minute. Stop and scrape bowl. Add eggs and chocolate. Continuing on Speed 2, mix about 30 seconds. Stop and scrape bowl. Turn to Speed 6 and beat about 1 minute.

Pour batter into two greased and floured 8- or 9-inch round baking pans. Bake at 350°F for 30 to 35 minutes, or until toothpick inserted in center comes out clean. Cool 10 minutes. Remove from pans. Cool completely on wire rack. Frost if desired.

Yield: 12 to 16 servings.

Per serving: About 285 cal, 4 g pro, 41 g carb, 12 g fat, 37 mg chol, 185 mg sod.

Apple Cake

- 1½ cups all-purpose flour
- 1 cup whole wheat flour
- 1½ cups sugar
- 1 teaspoon baking powder
- 1 teaspoon baking soda
- ½ teaspoon salt
- 1½ teaspoons cinnamon
- ½ teaspoon nutmeg
- 1½ cups applesauce
- ½ cup butter or margarine, melted
- 2 eggs
- 1 cup chopped, peeled apple
- ½ cup chopped walnuts
- Caramel Creme Frosting, if desired (see page 38)

Combine dry ingredients in mixer bowl. Add applesauce, butter, and eggs. Attach bowl and flat beater to mixer. Turn to Speed 2 and mix about 1 minute. Stop and scrape bowl. Turn to Speed 4 and beat about 30 seconds. Add apple and walnuts. Turn to STIR Speed and mix just until blended.

Pour batter into greased and floured 13x9x2-inch baking pan. Bake at 350°F for 35 to 40 minutes, or until toothpick inserted in center comes out clean. Cool completely on wire rack. Frost with **Caramel Creme Frosting**, if desired.

Yield: 12 to 16 servings.

Per serving: About 318 cal, 5 g pro, 51 g carb, 11 g fat, 36 mg chol, 315 mg sod.

VARIATION

Apple Cake Made Ahead

Double all ingredients and prepare in 6 quart mixer bowl. Bake in two pans. Enjoy one cake now; freeze the second and frost when ready to serve.

Yield: 24 to 32 servings.

Sunshine Chiffon Cake

- 2 cups all-purpose flour
- 1½ cups sugar
- 1 tablespoon baking powder
- ½ teaspoon salt
- ¾ cup cold water
- ½ cup oil
- 7 egg yolks, beaten
- 1 teaspoon vanilla
- 2 teaspoons grated lemon rind
- 7 egg whites
- ½ teaspoon cream of tartar

Combine flour, sugar, baking powder, and salt in mixer bowl. Add water, oil, egg yolks, vanilla, and lemon rind. Attach bowl and wire whip to mixer. Turn to Speed 4 and beat about 1 minute. Stop and scrape bowl. Continuing on Speed 4, beat about 15 seconds. Pour mixture into another bowl. Clean mixer bowl and wire whip.

Place egg whites and cream of tartar in mixer bowl. Attach bowl and wire whip to mixer. Turn to Speed 8 and whip 2 to 2½ minutes, or until whites are stiff but not dry.

Remove bowl from mixer. Gradually add flour mixture to egg whites. Fold in gently with spatula, just until blended.

Pour batter into ungreased 10-inch tube pan. Bake at 325°F for 60 to 75 minutes, or until top springs back when lightly touched. Immediately invert cake onto funnel or soft drink bottle. Cool completely. Remove from pan. Drizzle with **Lemon Glaze**.

Lemon Glaze

- 1 cup powdered sugar
- 1 tablespoon butter or margarine, softened
- 2-3 tablespoons lemon juice

Combine powdered sugar and butter in small bowl. Stir in lemon juice, 1 tablespoon at a time, until glaze is of desired consistency.

Yield: 16 servings.

Per serving: About 256 cal, 4 g pro, 38 g carb, 10 g fat, 93 mg chol, 152 mg sod.

Chocolate Almond Brownie Cake

Cake

- 7 squares (1 oz. each) semi-sweet chocolate
- ½ cup butter or margarine
- 3 eggs, separated
- ½ cup sugar
- ½ teaspoon almond extract
- 2 tablespoons all-purpose flour

To make **Cake**, melt chocolate and butter in medium saucepan over low heat, stirring constantly. Remove from heat; cool slightly.

Place egg whites in mixer bowl. Attach bowl and wire whip to mixer. Turn to Speed 8 and whip 1 to 2 minutes, or until stiff peaks form. Place egg whites in another bowl. Clean mixer bowl and wire whip.

Place chocolate mixture, sugar, and almond extract in mixer bowl. Attach bowl and flat beater to mixer. Turn to Speed 4 and beat about 1 minute. Stop and scrape bowl. Continuing on Speed 4, add egg yolks, one at a time, beating about 30 seconds after each addition. Continuing on Speed 4, add flour and beat about 15 seconds. Gently fold in egg whites with spatula.

Glaze

- 1 square (1 oz.) semi-sweet chocolate
- 1 teaspoon shortening

Spoon batter into 8-inch springform pan that has been greased and floured on the bottom only. Bake at 375°F for 20 to 25 minutes, or until set in center. Cool completely on wire rack before glazing. Clean mixer bowl.

Topping

- ½ cup whipping cream
- 1 tablespoon powdered sugar
- ¼ teaspoon almond extract
- 2 tablespoons sliced almonds

To make **Glaze**, melt chocolate and shortening in small saucepan over low heat, stirring to blend. Drizzle over cake.

To make **Topping**, place cream, powdered sugar, and almond extract in mixer bowl. Attach wire whip and bowl to mixer. Turn to Speed 10 and whip 30 to 60 seconds, or until stiff peaks form. Pipe or spoon whipped cream in ring over top of cake. Sprinkle with almonds. Store in refrigerator.

Yield: 16 servings.

Per serving: About 180 cal, 3 g pro, 17 g carb, 13 g fat, 58 mg chol, 74 mg sod.

Double Lemon Cake Roll

Cake

- 4 eggs
- $\frac{3}{4}$ cup granulated sugar
- $\frac{1}{4}$ cup water
- $\frac{1}{2}$ teaspoon vanilla
- $\frac{1}{2}$ teaspoon lemon extract
- $\frac{2}{3}$ cup all-purpose flour
- 1 teaspoon baking powder
- $\frac{1}{4}$ teaspoon salt

To make **Cake**, place eggs in mixer bowl. Attach bowl and wire whip to mixer. Turn to Speed 8 and whip eggs about 3 minutes, or until very thick and lemon colored. Continuing on Speed 8, gradually add sugar, beating about 1 minute. Stop and scrape bowl.

Add water, vanilla, and lemon extract. Turn to Speed 4 and beat about 30 seconds. Continuing on Speed 4, gradually add flour, baking powder, and salt. Beat about 30 seconds, or until batter is smooth.

Lemon Filling

- 1 package (8 oz.) light cream cheese, softened
- 1 cup powdered sugar
- 1 tablespoon lemon juice
- 2 teaspoons grated lemon peel

Line a 15½ x10½ x1-inch baking pan with waxed paper, aluminum foil, or parchment paper. Grease well. Pour batter into pan, spreading to corners. Bake at 375°F for 11 to 13 minutes, or until toothpick inserted in center comes out clean. Remove from oven and immediately turn onto a towel sprinkled with powdered sugar. Remove paper or foil. Roll cake and towel together. Cool completely on wire rack.

Meanwhile, to make **Lemon Filling**, place ingredients in mixer bowl. Attach bowl and flat beater to mixer. Turn to Speed 4 and beat about 1½ minutes, or until well mixed. Spread on cooled cake roll.

When cool, unroll cake and spread with Lemon Filling. Reroll and sprinkle with powdered sugar.

Yield: 10 servings (1-inch slice per serving).

Per serving: About 217 cal, 6 g pro, 35 g carb, 6 g fat, 96 mg chol, 213 mg sod.

Gingered Pear Upside-Down Cake

Topping

- ½ cup packed brown sugar*
- ¼ cup butter or margarine*
- 1 tablespoon light corn syrup*
- 1 tablespoon finely chopped crystallized ginger*
- 1 large ripe pear*

To make **Topping**, combine brown sugar, butter, and corn syrup in small saucepan. Cook and stir over medium-low heat for 3 to 5 minutes, or until smooth. Pour evenly into 9-inch round or square cake pan that has been sprayed with no-stick cooking spray. Sprinkle evenly with chopped ginger. Set aside.

Cake

- 1 cup granulated sugar*
- ½ cup shortening*
- 1 teaspoon vanilla*
- 2 eggs*
- 1½ cups all-purpose flour*
- ½ cup low-fat milk*
- 1 tablespoon finely chopped crystallized ginger*
- 1½ teaspoons baking powder*
- ½ teaspoon nutmeg*
- ¼ teaspoon salt*

To make **Cake**, place granulated sugar, shortening, and vanilla in mixer bowl. Attach bowl and flat beater to mixer. Turn to Speed 2 and mix about 45 seconds. Continuing on Speed 2, add eggs and mix about 45 seconds longer. Continuing on Speed 2, add remaining cake ingredients and mix about 30 seconds. Stop and scrape bowl. Turn to Speed 6 and beat about 1 minute.

Peel, core, and slice pear. Arrange pear slices evenly over sugar mixture in pan. Spread batter evenly over pear slices.

Bake at 350°F for 45 to 55 minutes, or until center springs back when touched lightly. Let stand in pan about 3 minutes. Invert onto serving plate. Serve warm or at room temperature.

Yield: 8 servings.

Per serving: About 462 cal, 5 g pro, 66 g carb, 21 g fat, 70 mg chol, 210 mg sod.

Cappuccino Fudge Cupcakes

Cupcakes

- ½ cup butter or margarine, softened*
- 1½ cups sugar*
- 3 eggs*
- ¾ cup milk*
- 1 tablespoon plus 2 teaspoons instant espresso or coffee granules*
- 1¾ cups all-purpose flour*
- 1½ teaspoons baking powder*
- ¼ teaspoon salt*

Coffee Cream

- 1½ cups heavy cream*
- ¼ cup sugar*
- 1½ teaspoons instant espresso or coffee granules (optional)*

Fudge Sauce

- 4 squares (1 oz. each) semi-sweet chocolate*
- ½ cup whipping cream*
- ¼ teaspoon cinnamon*

To make **Cupcakes**, place butter in bowl. Attach bowl and flat beater to mixer. Turn to Speed 6 and gradually add sugar, beating about 3 minutes, or until light and fluffy. Turn to Speed 4 and add eggs, one at a time, beating for 30 seconds after each addition. Stop and scrape bowl. Dissolve instant espresso in milk. Set aside.

Combine flour, baking powder, and salt. Turn to STIR Speed and add ½ of the flour mixture alternately with ½ of the milk mixture, mixing 15 seconds after each addition.

Spoon batter into 8 greased and floured custard cups. Place cups on baking sheet. Bake at 350°F for 30 to 35 minutes, or until toothpick inserted into cupcake comes out clean. Remove from custard cups and cool on wire rack. Top with **Coffee Cream** and serve with **Fudge Sauce**.

To make **Coffee Cream**, combine cream, sugar, and espresso in bowl. Attach bowl and wire whip to mixer. Turn to Speed 8 and whip cream until stiff.

To make **Fudge Sauce**, place chocolate, cream, and cinnamon in small saucepan. Cook and stir over low heat until chocolate is melted and mixture is combined.

Yield: 8 servings (8 cupcakes).

Per serving: About 690 cal, 8 g pro, 76 g carb, 40 g fat, 187 mg chol, 291 mg sod.

VARIATION

Cupcakes for a Party

Double all ingredients and prepare in 6 quart mixer bowl. Fill paper-lined standard-size muffin pans two-thirds full. Bake at 350°F for 18 to 22 minutes, or until toothpick inserted into cupcake comes out clean.

Yield: 48 cupcakes (48 servings).

Per serving: About 227 cal, 3 g pro, 25g carb, 14 g fat, 64 mg chol, 59 mg sod.

Caramel Creme Frosting

- ½ cup butter or margarine*
- 1 cup firmly packed brown sugar*
- ¼ cup low-fat milk*
- 1 cup miniature marshmallows*
- 2 cups powdered sugar*
- ½ teaspoon vanilla*

Melt butter in medium saucepan. Add brown sugar and milk, stirring to blend. Heat to boiling. Cook about 1 minute, stirring constantly. Remove from heat. Add marshmallows. Stir until marshmallows melt and mixture is smooth.

Place powdered sugar in mixer bowl. Add brown sugar mixture and vanilla. Attach bowl and flat beater to mixer. Turn to STIR Speed and mix about 30 seconds. Turn to Speed 4 and beat about 1 minute, or until smooth and creamy. Spread on cake while warm.

Yield: 12 to 16 servings (frosting for 2-layer or 13x9x2-inch cake).

Per serving: About 228 cal, 0 g pro, 41 g carb, 7 g fat, 0 mg chol, 98 mg sod.

Fluffy Frosting

- 1½ cups sugar*
- ½ teaspoon cream of tartar*
- ½ teaspoon salt*
- ½ cup water*
- 1½ tablespoons light corn syrup*
- 2 egg whites*
- 1½ teaspoons vanilla*

Place sugar, cream of tartar, salt, water, and corn syrup in saucepan. Cook and stir over medium heat until sugar is completely dissolved, forming a syrup.

Place egg whites in mixer bowl. Attach bowl and wire whip to mixer. Turn to Speed 10 and whip about 45 seconds, or until whites begin to hold shape. Continuing on Speed 10, slowly pour hot syrup into egg whites in a fine stream and whip 1 to 1½ minutes. Add vanilla and whip about 5 minutes longer, or until frosting loses its gloss and stands in stiff peaks. Frost cake immediately.

Yield: 12 to 16 servings (frosting for 2-layer or 13x9x2-inch cake).

Per serving: About 109 cal, 1 g pro, 27 g carb, 0 g fat, 0 mg chol, 101 mg sod.

Buttercream Frosting

- 1/2 cup butter or margarine, softened*
- 1/4 cup whipping cream or evaporated milk*
- 1 teaspoon vanilla*
- 1/4 teaspoon salt*
- 4 cups powdered sugar, divided*
- Low-fat milk, if necessary*

Place butter in mixer bowl. Attach bowl and flat beater to mixer. Turn to Speed 4 and beat about 1 minute, or until creamy. Stop and scrape bowl. Add cream, vanilla, salt, and 1 cup powdered sugar. Turn to STIR Speed and mix about 30 seconds. Stop and scrape bowl. Turn to Speed 2 and mix about 1 1/2 minutes, or until well blended. Stop and scrape bowl.

Turn to STIR Speed. Gradually add remaining 3 cups powdered sugar and mix until blended. Stop and scrape bowl, if necessary. Add milk, 1 teaspoon at a time, if necessary. Turn to Speed 4 and beat about 1 minute, or until smooth.

Yield: 12 to 16 servings (frosting for 2-layer or 13x9x2-inch cake).

Per serving: About 219 cal, 0 g pro, 40 g carb, 7 g fat, 21 mg chol, 103 mg sod.

VARIATION

Chocolate Buttercream Frosting

Mix 1/2 cup cocoa with powdered sugar in small bowl. Add to softened butter, cream, vanilla, and salt. Continue as directed above.

Yield 12 to 16 servings (frosting for 2-layer or 13x9x2-inch cake)

Per serving: About 224 cal, 1 g pro, 41 g carb, 7 g fat, 21 mg chol, 103 mg sod.

Orange Cream Cheese Frosting

- 4 cups powdered sugar*
- 1 package (8 oz.) light cream cheese*
- 1 teaspoon orange juice*
- 1/2 teaspoon grated orange peel*

Place all ingredients in mixer bowl. Attach bowl and flat beater to mixer. Turn to STIR Speed and mix about 30 seconds, or until blended. Turn to Speed 4 and beat about 2 minutes, or until smooth and creamy.

Yield: 12 to 16 servings (frosting for 2-layer or 13x9x2-inch cake).

Per serving: About 196 cal, 2 g pro, 41 g carb, 3 g fat, 7 mg chol, 107 mg sod.

Creamy No-Cook Mints

- 3 ounces light cream cheese
- $\frac{1}{4}$ teaspoon mint flavoring
- 2 drops green food color or color of choice
- $4\frac{1}{4}$ - $4\frac{1}{2}$ cups powdered sugar
Superfine sugar

Place cream cheese, flavoring, and food color in mixer bowl. Attach bowl and flat beater to mixer. Turn to Speed 2 and mix about 30 seconds, or until smooth. Continuing on Speed 2, gradually add powdered sugar and mix about $1\frac{1}{2}$ minutes, or until mixture becomes very stiff.

To make mints, dip individual flexible candy molds in superfine sugar. Press in mint mixture. Turn out onto waxed paper covered with superfine sugar. Repeat until all mixture is used. OR: Shape mixture into $\frac{3}{4}$ -inch balls, using about 1 teaspoon for each ball. Roll in superfine sugar. Place on waxed paper covered with superfine sugar. Flatten slightly with thumb to form $\frac{1}{4}$ -inch thick patties. If desired, press back of fork lightly on patties to form ridges.

Store mints, tightly covered, in refrigerator. Mints also freeze well.

Yield: 42 servings (2 candies per serving).

Per serving: About 54 cal, 0 g pro, 13 g carb, 0 g fat, 1 mg chol, 12 mg sod.

Chocolate Fudge

- Butter*
- 2 cups sugar
- 1/8 teaspoon salt
- 3/4 cup evaporated milk
- 1 teaspoon light corn syrup
- 2 squares (1 oz. each) unsweetened chocolate
- 2 tablespoons butter or margarine
- 1 teaspoon vanilla
- 2 cup chopped walnuts or pecans

Butter sides of heavy 2-quart saucepan. Combine sugar, salt, evaporated milk, corn syrup, and chocolate in pan. Cook and stir over medium heat until chocolate melts and sugar dissolves. Cook to soft ball stage (236°F) without stirring. Remove immediately from heat. Add butter without stirring. Cool to lukewarm (110°F). Stir in vanilla.

Pour mixture into mixer bowl. Attach bowl and flat beater to mixer. Turn to Speed 2 and mix about 8 minutes, or until fudge stiffens and loses its gloss. Quickly turn to STIR Speed and add walnuts, mixing just until blended. Spread in buttered 9x9x2-inch baking pan. Cool at room temperature. Cut into 1-inch squares when firm.

Yield: 64 servings (1 square per serving).

Per serving: About 59 cal, 1 g pro, 7 g carb, 3 g fat, 1 mg chol, 12 mg sod.

VARIATION

Chocolate Fudge for a Crowd

Triple all ingredients and prepare in the 6 quart mixer bowl. Increase mixing time at Speed 2 to 9 minutes. Spread in buttered 15x10x1-inch baking pan. Cut into 1-inch squares when firm.

Yield: 150 servings (1 square per serving).

Per serving: About 75 cal, 2 g pro, 9 g carb, 4 g fat, 1 mg chol, 15 mg chol.

Divinity

- 3 cups sugar
- $\frac{3}{4}$ cup light corn syrup
- $\frac{1}{2}$ cup water
- 2 egg whites
- 1 teaspoon almond extract
- 1 cup chopped walnuts or pecans

Place sugar, corn syrup, and water in heavy saucepan. Cook and stir over medium heat to hard ball stage (248°F). Remove from heat and let stand until temperature drops to 220°F, without stirring.

Place egg whites in mixer bowl. Attach bowl and wire whip to mixer. Turn to Speed 8 and whip about 1 minute, or until soft peaks form. Gradually add syrup in a fine stream and whip about 2½ minutes longer.

Turn to Speed 4. Add almond extract and whip 20 to 25 minutes, or until mixture starts to become dry. Turn to STIR Speed and add walnuts, mixing just until blended.

Drop mixture from measuring tablespoon onto waxed paper or greased baking sheet to form patties.

Yield: 20 servings (2 pieces per serving).

Per serving: About 192 cal, 2 g pro, 40 g carb, 4 g fat, 0 mg chol, 15 mg sod.

Chocolate Chip Cookies

- 1 cup granulated sugar
- 1 cup brown sugar
- 1 cup butter or margarine, softened
- 2 eggs
- 1½ teaspoons vanilla
- 1 teaspoon baking soda
- 1 teaspoon salt
- 3 cups all-purpose flour
- 12 ounces semi-sweet chocolate chips

Place sugars, butter, eggs, and vanilla in mixer bowl. Attach bowl and flat beater to mixer. Turn to Speed 2 and mix about 30 seconds. Stop and scrape bowl. Turn to Speed 4 and beat about 30 seconds. Stop and scrape bowl.

Turn to STIR Speed. Gradually add baking soda, salt, and flour to sugar mixture and mix about 2 minutes. Turn to Speed 2 and mix about 30 seconds. Stop mixer and scrape bowl. Add chocolate chips. Turn to STIR Speed and mix about 15 seconds.

Drop by rounded teaspoonfuls onto greased baking sheets, about 2 inches apart. Bake at 375°F for 10 to 12 minutes. Remove from baking sheets immediately and cool on wire racks.

Yield: 54 servings (1 cookie per serving).

Per serving: About 117 cal, 1 g pro, 17 g carb, 5 g fat, 8 mg chol, 106 mg sod.

VARIATIONS

Macadamia Chocolate Chunk Cookies

Decrease granulated sugar to ¾ cup. Decrease flour to 2¼ cups. Add ½ cup unsweetened cocoa powder with the flour. Follow mixing directions above. Omit chocolate chips. Turn to STIR Speed. Add 1 package (8 oz.) semi-sweet baking chocolate, cut into small chunks, and 1 jar (3½ oz.) macadamia nuts, coarsely chopped. Mix just until blended. Bake at 325°F for 12 to 13 minutes, or until edges are set. Do not overbake. Cool on baking sheet about 1 minute. Cool completely on wire racks.

Yield: 48 servings (1 cookie per serving.)

Per serving: About 125 cal, 2 g pro, 16 g carb, 7 g fat, 9 mg chol, 107 mg sod.

Cookies for the Freezer

Double the ingredients and prepare in 6 quart mixer bowl. Enjoy some now and freeze the rest.

Yield: 108 servings for Chocolate Chip cookies or 96 servings for Macadamia Chocolate Chunk Cookies (1 cookie per serving).

Peanut Butter Cookies

- ½ cup peanut butter*
- ½ cup butter or margarine, softened*
- ½ cup granulated sugar*
- ½ cup brown sugar*
- 1 egg*
- ½ teaspoon vanilla*
- ½ teaspoon baking soda*
- ¼ teaspoon salt*
- 1¼ cups all-purpose flour*

Place peanut butter and butter in mixer bowl. Attach bowl and flat beater to mixer. Turn to Speed 6 and beat about 1 minute, or until mixture is smooth. Stop and scrape bowl. Add sugars, egg, and vanilla. Turn to Speed 4 and beat about 1 minute. Stop and scrape bowl.

Turn to STIR Speed. Gradually add all remaining ingredients to sugar mixture and mix about 30 seconds. Turn to Speed 2 and mix about 30 seconds.

Roll dough into 1-inch balls. Place about 2 inches apart on ungreased baking sheets. Press flat with fork in a criss-cross pattern to ¼-inch thickness.

Bake at 375°F for 10 to 12 minutes, or until golden brown. Remove from baking sheets immediately and cool on wire racks.

Yield: 36 servings (1 cookie per serving).

Per serving: About 83 cal, 2 g pro, 10 g carb, 4 g fat, 6 mg chol, 81 mg sod.

Nutty Shortbread Bars

- 1 cup butter or margarine, softened*
- 1 cup firmly packed brown sugar*
- 2 cups all-purpose flour*
- 1 teaspoon baking powder*
- ½ teaspoon salt*
- 2 egg whites*
- 1 cup chopped walnuts or pecans*

Place butter and brown sugar in mixer bowl. Attach bowl and flat beater to mixer. Turn to Speed 2 and mix about 1 minute. Stop and scrape bowl. Add flour, baking powder, and salt. Turn to Speed 2 and mix about 1½ minutes, or until soft dough forms.

Press dough into greased 15½x10½x1-inch baking pan. Beat egg whites with fork until slightly foamy. Brush dough with egg whites, using only as much as needed to cover lightly. Sprinkle with chopped walnuts.

Bake at 375°F for 20 to 25 minutes. Cut into bars while warm. Cool on wire rack.

Yield: 30 servings (1 bar per serving).

Per serving: About 139 cal, 2 g pro, 14 g carb, 8 g fat, 17 mg chol, 114 mg sod.

Lemon Cream Cheese Bars

Crust

- 2 cups all-purpose flour
- ½ cup powdered sugar
- 1 cup (2 sticks) chilled butter, cut into chunks

Place **Crust** ingredients in mixer bowl. Attach bowl and flat beater to mixer. Turn to STIR Speed and mix about 1 minute, or until well blended and mixture starts to stick together. Press into ungreased 15½x10½x1-inch baking pan. Bake at 350°F for 14 to 16 minutes, or until set. (**NOTE:** Check **Crust** after 10 minutes and prick with fork if it puffs up during baking.) Remove from oven.

Cream Cheese Filling

- 1 package (8 oz.) light cream cheese
- ½ cup powdered sugar
- 2 tablespoons flour
- 2 eggs
- 1 teaspoon vanilla

Meanwhile, clean mixer bowl and beater. Place **Cream Cheese Filling** ingredients in mixer bowl. Attach bowl and flat beater to mixer. Turn to STIR Speed and mix about 30 seconds. Turn to Speed 4 and beat about 2 minutes, or until smooth and creamy. Pour over partially baked Crust. Bake at 350°F for 6 to 7 minutes, or until filling is slightly set. Remove from oven.

Lemon Filling

- 4 eggs
- 2 cups granulated sugar
- ¼ cup all-purpose flour
- 1 teaspoon grated lemon peel
- ¼ cup lemon juice
- Powdered sugar, if desired

Meanwhile, clean mixer bowl and beater. Place all **Lemon Filling** ingredients, except lemon juice, in mixer bowl. Attach bowl and flat beater to mixer. Turn to STIR Speed and mix about 30 seconds. Turn to Speed 2. Gradually add lemon juice and mix about 30 seconds, or until well blended. Pour over **Cream Cheese Filling**. Bake at 350°F for 14 to 16 minutes, or until filling is set. (**NOTE:** Filling may puff up during baking but will fall when removed from oven.) Sprinkle with powdered sugar, if desired. Cool completely in pan.

Yield: 48 servings (1 bar per serving).

Per serving: About 115 cal, 2 g pro, 16 g carb, 5 g fat, 39 mg chol, 65 mg sod.

Sugar Cookies

- ½ cup butter or margarine, softened*
- ¾ cup sugar*
- 1 egg*
- 1 teaspoon vanilla*
- 2 cups all-purpose flour*
- ½ teaspoon baking soda*
- ¼ teaspoon salt*

Place butter and sugar in mixer bowl. Attach bowl and flat beater to mixer. Turn to Speed 2 and mix 30 seconds. Turn to speed 4 and beat about 1½ minutes. Stop and scrape bowl. Add egg and vanilla. Turn to Speed 6 and beat about 1 minute.

Combine flour, soda and salt. Add to mixer bowl. Turn to STIR Speed and beat about 30 seconds. Stop and scrape bowl. Turn to Speed 2 and mix about 45 seconds. Shape dough into a flat ball. Wrap in plastic wrap. Chill in refrigerator 2 to 3 hours.

Divide dough into thirds. Roll each portion ⅛-inch thick on lightly floured waxed paper. Cut with cookie cutters and place on lightly greased baking sheets. Bake at 375°F for 7 to 10 minutes, or until edges are light brown. Remove from baking sheets immediately and cool on wire racks.

Yield: 48 servings (1 cookie per serving).

Per serving: About 50 cal, 1 g pro, 7 g carb, 2 g fat, 10 mg chol, 46 mg sod.

VARIATION

Sugar Cookies for a Crowd

Double the ingredients and prepare in the 6 quart mixer bowl.

Yield: 96 servings (1 cookie per serving).

Raisin-Apricot Oatmeal Cookies

- ½ cup butter or margarine*
- ½ cup shortening*
- ¾ cup granulated sugar*
- ¼ cup packed brown sugar*
- 2 teaspoons vanilla*
- 2 eggs*
- 2 cups quick cooking oats*
- 1½ cups all-purpose flour*
- 1 teaspoon baking soda*
- ½ teaspoon salt*
- ¾ cup raisins*
- ½ cup chopped dried apricots*

Place butter, shortening, vanilla, sugars, and eggs in mixer bowl. Attach bowl and flat beater to mixer. Turn to Speed 2 and mix about 30 seconds. Stop mixer and scrape bowl. Turn to Speed 4 and beat about 30 seconds. Stop and scrape bowl. Add oats, flour, baking soda, salt, raisins, and apricots. Turn to Speed 2 and mix about 30 seconds.

Drop by rounded teaspoonfuls onto greased baking sheets. Bake at 375°F for 8 to 10 minutes, or until light golden brown.

Yield: 48 servings (1 cookie per serving)

Per serving: About 91 cal, 1 g pro, 12 g carb, 5 g fat, 14 mg chol, 74 mg sod.

VARIATION

Cookies for the Freezer

Double the ingredients and prepare in 6 quart mixer bowl. Enjoy cookies now and freeze some for later.

Yield: 96 servings (1 cookie per serving).

Almond Kisses

- 3 *egg whites*
- 1½ *cups sugar*
- 1 *teaspoon almond extract*
- 2 *cups sliced almonds*

Place egg whites in mixer bowl. Attach bowl and wire whip to mixer. Gradually turn to Speed 10 and whip about 2 minutes, or until soft peaks form.

Reduce to Speed 4 and gradually add sugar, beating about 1 minute. Stop and scrape bowl. Add almond extract. Turn to Speed 10 and whip 1½ minutes, or until very stiff. Fold in almonds with rubber spatula.

Drop by tablespoonfuls onto greased and floured or parchment paper-covered baking sheets. Bake at 325°F for 15 minutes. Cool on wire racks.

Yield: 36 servings (1 cookie per serving).

Per serving: About 66 cal, 1 g pro, 9 g carb, 3 g fat, 0 mg chol, 5 mg sod.

VARIATION

Almond Kisses for Gift Giving

- 12 *egg whites*
- 6 *cups sugar*
- 1 *tablespoon almond extract*
- 6 *cups sliced almonds*

Prepare as directed above, using 6 quart mixer bowl.

Yield: 144 servings (1 cookie per serving).

Tip: After cookies are completely cooled, pack in layers in covered container. Freeze up to 1 month.

Crispy Cheese Wafers

- 3 cups (12 oz.)
shredded extra sharp
Cheddar cheese
- $\frac{3}{4}$ cup butter or
margarine, softened
and cut up
- $1\frac{1}{2}$ cups all-purpose
flour
- $\frac{1}{2}$ teaspoon cayenne

Place cheese and butter in mixer bowl. Attach bowl and flat beater to mixer. Turn to Speed 2 and mix about 45 seconds. Turn to Speed 4 and beat about 30 seconds, or until well blended. Add flour and cayenne. Turn to STIR Speed and mix about 45 seconds, or until mixture forms a ball.

Divide dough in half. Wrap half of dough in plastic wrap and refrigerate. On floured surface with floured rolling pin, roll remaining half of dough to $\frac{1}{4}$ inch thick (about 12x9-inch rectangle). Cut into 1x3-inch strips. With floured spatula, place on large lightly greased baking sheets. Bake at 375°F for 10 to 12 minutes, or until set. Let stand 1 minute. Remove from pans and cool on wire rack. Repeat with remaining dough. Serve warm or at room temperature.

Yield: 30 servings (2 wafers per serving).

Per serving: About 108 cal, 4 g pro, 5 g carb,
8 g fat, 12 mg chol, 126 mg sod.

Pie Pastry

- 2¼ cups
all-purpose flour
- ¾ teaspoon salt
- ½ cup shortening, well
chilled
- 2 tablespoons butter
or margarine,
well chilled
- 5-6 tablespoons
cold water

Place flour and salt in mixer bowl. Attach bowl and flat beater to mixer. Turn to STIR Speed and mix about 15 seconds. Cut shortening and butter into pieces and add to flour mixture. Turn to STIR Speed and mix 30 to 45 seconds, or until shortening particles are size of small peas.

Continuing on STIR Speed, add water, 1 tablespoon at a time, mixing until all particles are moistened and dough begins to hold together.

Divide dough in half. Pat each half into a smooth ball and flatten slightly. Wrap in plastic wrap. Chill in refrigerator 15 minutes.

Roll one half of dough to ⅛-inch thickness between waxed paper. Fold pastry into quarters. Ease into 8- or 9-inch pie plate and unfold, pressing firmly against bottom and sides. Continue with one of the procedures that follow.

For One-crust Pie: Fold edge under. Crimp, as desired. Add desired pie filling. Bake as directed.

For Two-crust Pie: Trim pastry even with edge of pie plate. Using second half of dough, roll out another pastry crust. Add desired pie filling. Top with second pastry crust. Seal edge. Crimp, as desired. Cut slits for steam to escape. Bake as directed.

For Baked Pastry Shell: Fold edge under. Crimp, as desired. Prick sides and bottom with fork. Bake at 450°F for 8 to 10 minutes, or until lightly browned. Cool completely on wire rack and fill.

Alternate Method for Baked Pastry Shell: Fold edge under. Crimp, as desired. Line shell with foil. Fill with pie weights or dried beans. Bake at 450°F for 10 to 12 minutes, or until edges are lightly browned. Remove pie weights and foil. Cool completely on wire rack and fill.

Yield: 8 servings (two 8- or 9-inch crusts).

Per serving (one crust): About 134 cal, 2 g pro, 13 g carb, 8 g fat, 0 mg chol, 118 mg sod.

Per serving (two crusts): About 267 cal, 4 g pro, 27 g carb, 16 g fat, 0 mg chol, 236 mg sod.

VARIATION

Pastry for Four Pie Crusts

Double the ingredients and prepare in the 6 quart mixer bowl.

Yield: 16 servings (four 8- or 9-inch crusts).

Lemony Light Cheesecake

Crust

- 15 *reduced-fat creme-filled chocolate sandwich cookies, finely crushed (about 1½ cups crumbs)*
- 2 *tablespoons butter or margarine, melted*

Filling

- 3 *packages (8 oz. each) light cream cheese*
- 1 *cup sugar*
- 1 *tablespoon all-purpose flour*
- 4 *eggs*
- ¼ *cup lemon juice*
- 1 *teaspoon grated lemon peel*

Spray bottom and sides of 9-inch springform pan with no-stick cooking spray.

To make **Crust**, combine cookie crumbs and butter in medium bowl; mix well. Press mixture firmly into bottom of springform pan. Chill while making Filling.

To make **Filling**, place cream cheese, sugar, and flour in mixer bowl. Attach bowl and flat beater to mixer. Turn to Speed 2 and mix about 30 seconds. Stop and scrape bowl. Turn to Speed 2 and mix about 30 seconds longer. Stop and scrape bowl.

Add eggs, lemon juice, and lemon peel. Turn to STIR Speed and mix about 30 seconds. Stop and scrape bowl. Turn to Speed 2 and mix 15 to 30 seconds longer, just until blended. Do not overbeat. Pour Filling into Crust.

Place top oven rack in center of oven. Place pan of hot water on bottom rack of oven. Place cheesecake on rack in center of oven. Bake at 325°F for 50 to 60 minutes, or until cheesecake is set when pan is jiggled slightly. Do not overbake.

Turn off oven; open oven door. Let cheesecake stand in oven 30 minutes. Remove from oven. Cool completely on wire rack away from drafts. Cover and refrigerate 6 to 8 hours before serving.

Yield: 16 servings.

Per serving: About 169 cal, 6 g pro, 20 g carb, 7 g fat, 68 mg chol, 214 mg sod.

Tawny Pumpkin Pie

- 1 can (16 oz.) pumpkin
- $\frac{3}{4}$ cup firmly packed brown sugar
- 3 eggs
- 1 teaspoon cinnamon
- $\frac{1}{2}$ teaspoon ginger
- $\frac{1}{2}$ teaspoon salt
- $\frac{1}{4}$ teaspoon cloves
- $\frac{1}{4}$ cups low-fat milk
- Pie Pastry for One-crust Pie (see page 50)

Place pumpkin, brown sugar, eggs, cinnamon, ginger, salt, and cloves in mixer bowl. Attach bowl and flat beater to mixer. Turn to Speed 2 and mix about 30 seconds. Stop and scrap bowl. Continuing on Speed 2, slowly add milk and mix about $1\frac{1}{2}$ minutes.

Follow procedure for One-crust Pie. Fill with pumpkin mixture. Bake at 400°F for 40 to 50 minutes, or until knife inserted near center comes out clean.

Yield: 8 servings.

Per serving (filling and crust): About 280 cal, 6 g pro, 41 g carb, 11 g fat, 87 mg chol, 325 mg sod.

Cookies and Cream Sundae Pie

- 1 pie crust (9-inch) baked and cooled completely
- 3 cups ($1\frac{1}{2}$ pints) light cherry nut ice cream
- 1 cup (10) reduced-fat cream filled chocolate wafer cookies, cut up
- 1 cup prepared hot fudge topping, warmed slightly
- 4 cups (1 quart) light French silk chocolate or chocolate ice cream

Place cherry nut ice cream and half the cookies ($\frac{1}{2}$ cup) in mixer bowl. Attach bowl and flat beater to mixer. Turn to Speed 2 and mix about 20 seconds. Spoon quickly into pie crust. Top evenly with $\frac{3}{4}$ cup hot fudge topping. Freeze at least 1 hour.

Place French silk chocolate ice cream in mixer bowl with remaining $\frac{1}{2}$ cup cookies. Turn to Speed 2 and mix about 20 seconds. Spoon into pie crust. Drizzle with remaining $\frac{1}{4}$ cup hot fudge topping. Freeze at least 4 hours.

Yield: 8 servings.

Per serving: About 553 cal, 10 g pro, 91 g carb, 16 g fat, 10 mg chol, 445 mg sod.

Double Chocolate Mousse with Raspberry Sauce

Mousse

- 6 oz. *bittersweet chocolate, chopped in 3/4-inch chunks*
- 6 oz. *white chocolate, chopped in 3/4-inch chunks*
- 2 cups *whipping cream, divided*

To make **Mousse**, place bittersweet chocolate in one 3- to 4-cup microwave-safe bowl. Place white chocolate in a second microwave-safe bowl. Cover each with waxed paper. Place one bowl at a time into microwave oven and heat on HIGH for 1½ minutes. Stop and stir. If chocolate is not melted, repeat process for 30 seconds at a time, or until melted. Stop and stir.

Heat cream in a heavy saucepan over medium heat until very hot, but do not boil. Remove from heat. Pour one cup of cream into each of the chocolate bowls. Stir each until completely mixed. Cover bowls and refrigerate about 2 hours.

Raspberry Sauce

- 1 *package (14-16 oz.) frozen unsweetened raspberries, thawed*
- ¼ *cup water*
- ¼ *cup sugar*
- 1 *tablespoon cornstarch*

Pour white chocolate mixture into mixer bowl. Attach bowl and wire whip to mixer. Gradually turn to Speed 6 and beat 4 to 4½ minutes, or until soft peaks form. Spoon about ½ cup mixture into each of 6 stemmed dessert dishes. Set aside.

Pour bittersweet chocolate mixture into mixer bowl. Gradually turn to Speed 6, and beat about 3 minutes, or until soft peaks form. Spoon about ½ cup mixture over white chocolate layer. Cover dishes with plastic wrap or foil. Refrigerate 8 hours, or overnight.

To make **Raspberry Sauce**, place raspberries in blender container. Cover and blend until smooth. Pour mixture into a wire mesh strainer over a small saucepan; press with back of spoon to squeeze out liquid. Discard seeds and pulp in strainer.

Place remaining ingredients in saucepan. Cook over medium heat, stirring constantly, until thickened and bubbly. Remove from heat and cool. Store sauce in covered container in refrigerator. Stir before using.

Spoon **Raspberry Sauce** over chocolate in dessert dishes before serving.

Yield: 6 servings (⅔ cup mousse and ¼ cup raspberry sauce per serving).

Per serving: About 664 cal, 6 g pro, 53 g carb, 48 g fat, 115 mg chol, 57 mg sod.

Raspberry Filled Almond Meringue Dessert

Meringue

- 2 cups toasted slivered almonds, finely chopped
- 8 egg whites, room temperature
- 1 tablespoon vanilla
- 1 teaspoon white vinegar
- 2 cups powdered sugar

To make **Meringue**, place egg whites in mixer bowl. Attach bowl and wire whip to mixer. Turn to Speed 8 and whip about 1½ minutes, or until foamy. Continuing on Speed 8, add vanilla and vinegar. Whip about 5 seconds. Add powdered sugar. Turn to Speed 4 and beat about 5 seconds. Stop and scrape bowl. Turn to Speed 8 and whip about 2½ minutes, or until stiff but not dry. Stop and scrape bowl. Add nuts. Turn to STIR and mix about 10 seconds, or until well blended.

Divide egg white mixture equally between two 9-inch round baking pans lined with waxed paper cut to fit the pan bottoms, greased, and floured. Bake at 350°F for 25 to 35 minutes, or until golden brown. Cool in pans about 15 minutes. Remove from pans and cool completely on wire racks.

Filling

- 2 cups frozen raspberries (from 16 oz. bag)
- ½ cup granulated sugar
- 2 tablespoons cornstarch
- ¼ cup water or orange juice
- 1 cup whipping cream
- 3 tablespoons powdered sugar

To make **Filling**, place raspberries, granulated sugar, cornstarch, and water in medium saucepan. Cook and stir over medium heat until bubbly. Cook about 1 minute longer, or until thick and translucent, stirring constantly. Remove from heat. Strain seeds if desired. Cool completely.

Place whipping cream and powdered sugar in mixer bowl. Attach bowl and wire whip to mixer. Gradually turn to Speed 8 and whip about 1½ minutes, or until cream holds soft peaks. Stop mixer. Add cooled raspberry mixture. Turn to Speed 8 and whip about 15 seconds, or until thick and blended.

Place 1 meringue layer on serving plate. Top with half the filling. Top with remaining meringue layer and remaining filling. Freeze or refrigerate until serving. Garnish with fresh raspberries or almonds, if desired.

Yield: 8 servings.

Tip: To toast almonds, place in baking pan and bake at 375°F for 6 to 8 minutes.

Per serving: About 528 cal, 11 g pro, 58 g carb, 28 g fat, 41 mg chol, 71 mg sod.

General Instructions for Making and Kneading Yeast Dough with the Rapid Mix Method

“Rapid Mix” describes a bread baking method that calls for dry yeast to be mixed with other dry ingredients before liquid is added. In contrast, the traditional method is to dissolve yeast in warm water.

1. Place all dry ingredients including yeast into bowl, except last 1 to 2 cups flour.
2. Attach bowl and PowerKnead™ Spiral Dough Hook. Raise mixer bowl. Turn to Speed 2 and mix about 15 seconds, or until ingredients are combined.
3. Continuing on Speed 2, gradually add liquid ingredients to flour mixture and mix 1 to 2 minutes longer. See Illustration A.

NOTE: If liquid ingredients are added too quickly, they will form a pool around the PowerKnead™ Spiral Dough Hook and slow down mixing process.

4. Continuing on Speed 2, gently add remaining flour, $\frac{1}{2}$ cup at a time. See Illustration B. Mix until dough starts to clean sides of bowl, about 2 minutes.
5. Knead on Speed 2 for 2 more minutes, or until dough is smooth and elastic. See Illustration C.
6. Lower bowl on mixer and remove dough from the bowl and PowerKnead™ Spiral Dough Hook. Follow directions in recipe for rising, shaping and baking.

When using the traditional method to prepare a favorite recipe, dissolve yeast in warm water in warmed bowl. Add remaining liquids and dry ingredients, except last 1 to 2 cups flour. Turn to Speed 2 and mix about 1 minute, or until ingredients are thoroughly mixed. Proceed with Steps 4 through 6.



ILLUSTRATION A



ILLUSTRATION B



ILLUSTRATION C

Both methods work equally well for bread preparation. However, the “Rapid Mix” method may be a bit faster and easier for new bread bakers. It is slightly more temperature tolerant because the yeast is mixed with dry ingredients rather than with warm liquid.

Bread Making Tips

Making bread with a mixer is quite different from making bread by hand. Therefore, it will take some practice before you are completely comfortable with the new process. For your convenience, we offer these tips to help you become accustomed to bread making the KitchenAid® brand way.

- Start out with an easy recipe, like Basic White Bread, page 56, until you are familiar with using the PowerKnead™ Spiral Dough Hook.
- ALWAYS use the PowerKnead™ Spiral Dough Hook to mix and knead yeast doughs.
- Use **Speed 2** to mix or knead yeast doughs. Use of any other speed creates high potential for unit failure.
- NEVER use recipes calling for more than 14 cups all-purpose flour or 8 cups whole wheat flour when making dough with a 6 quart mixer.
- NEVER use recipes calling for more than 12 cups all-purpose flour or 6 cups whole wheat flour when making dough with a 5 quart mixer.
- Use a candy or other kitchen thermometer to assure that liquids are at temperature specified in the recipe. Liquids at higher temperature can kill yeast, while liquids at lower temperatures will retard yeast growth.
- Warm all ingredients to room temperature to insure proper rising of dough. If yeast is to be dissolved in bowl, always warm bowl first by rinsing with warm water to prevent cooling of liquids.
- Allow bread to rise in a warm place, 80°F to 85°F, free from draft, unless otherwise specified in recipe.
- Here are some alternative rising methods to use: (1) The bowl containing the dough can be placed on a wire rack over a pan of hot water. (2) The bowl can be placed on the top rack of an unheated oven; put a pan of hot water on the rack below. (3) Turn the oven to 400°F for 1 minute; then turn it off; place the bowl on the center rack of the oven and close the door.

Cover bowl with waxed paper, if desired. Always cover with towel to retain warmth in the bowl and protect the dough from drafts.
- Recipe rising times may vary due to temperature and humidity in your kitchen. Dough has doubled in bulk when indentation remains after tips of fingers are pressed lightly and quickly into dough.
- Most bread recipes give a range for the amount of flour to be used. Enough flour has been added when the dough starts to clean sides of bowl. If dough is sticky or humidity is high, slowly add more flour, about ½ cup at a time but NEVER exceed recommended flour capacity. Knead after each addition until flour is completely worked into dough. If too much flour is added, a dry loaf will result.
- When done, yeast breads and rolls should be deep golden brown in color. Other tests for doneness of breads are: Bread pulls away from the sides of pan, and tapping on the top of the loaf produces a hollow sound. Turn loaves and rolls onto racks immediately after baking to prevent sogginess.

Shaping A Loaf



Divide dough in half. On lightly floured surface, roll each half into a rectangle, approximately 9x14 inches. A rolling pin will smooth dough and remove gas bubbles.



Pinch ends and turn under. Place, seam side down, in loaf pan. Follow directions in recipe for rising and baking.

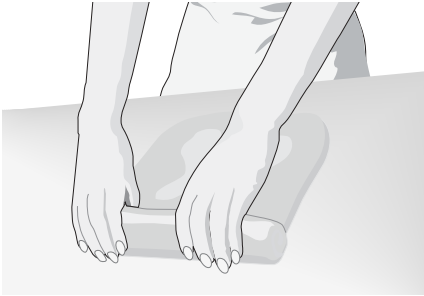

Starting at a short end, roll dough tightly. Pinch dough to seal seam.

Basic White Bread

- ½ cup low-fat milk*
- 3 tablespoons sugar*
- 2 teaspoons salt*
- 3 tablespoons butter or margarine*
- 2 packages active dry yeast*
- 1½ cups warm water (105°F to 115°F)*
- 5-6 cups all-purpose flour*

Place milk, sugar, salt, and butter in small saucepan. Heat over low heat until butter melts and sugar dissolves. Cool to lukewarm.

Dissolve yeast in warm water in warmed mixer bowl. Add lukewarm milk mixture and 4½ cups flour. Attach bowl and PowerKnead™ Spiral Dough Hook to mixer. Turn to Speed 2 and mix about 1 minute.

Continuing on Speed 2, add remaining flour, ½ cup at a time, and mix about 1½ minutes, or until dough starts to clean sides of bowl. Knead on Speed 2 about 2 minutes longer, or until dough is smooth and elastic. Dough will be slightly sticky to the touch.

Place dough in greased bowl, turning to grease top. Cover. Let rise in warm place, free from draft, about 1 hour, or until doubled in bulk.

Punch dough down and divide in half. Shape each half into a loaf, as directed on page 55, and place in greased 8½x4½x2½-inch baking pans. Cover. Let rise in warm place, free from draft, about 1 hour, or until doubled in bulk.

Bake at 400°F for 30 minutes, or until golden brown. Remove from pans immediately and cool on wire racks.

Yield: 32 servings (16 slices per loaf).

Per serving: About 95 cal, 3 g pro, 18 g carb, 1 g fat, 0 mg chol, 148 mg sod.

VARIATION

Extra Bread for the Freezer

Increase ingredient quantities by 50 percent and prepare in 6 quart mixer bowl. In second paragraph, change 4½ cups flour to 7 cups. Divide dough into 3 pieces.

Yield: 48 servings (16 slices per loaf).

Variations continued on next page.

Basic White Bread *CONTINUED*

VARIATIONS

Cinnamon Bread

Prepare dough, divide, and roll out each half to a rectangle, as directed on page 57. Mix together $\frac{1}{2}$ cup sugar and 2 teaspoons cinnamon in small bowl. Spread each rectangle with 1 tablespoon softened butter or margarine. Sprinkle with half of sugar mixture. Finish rolling and shaping loaves. Place in well-greased $8\frac{1}{2}\times 4\frac{1}{2}\times 2\frac{1}{2}$ -inch baking pans. Cover. Let rise in warm place, free from draft, about 1 hour, or until doubled in bulk. If desired, brush tops with beaten egg white. Bake at 375°F for 40 to 45 minutes, or until golden brown. Remove from pans immediately and cool on wire racks.

Yield: 32 servings (16 slices per loaf).

Per serving: About 111 cal, 3 g pro, 21 g carb, 2 g fat, 0 mg chol, 152 mg sod.

Sixty-Minute Rolls

Increase yeast to 3 packages and sugar to $\frac{1}{4}$ cup. Mix and knead dough as directed for Basic White Bread on page 56. Place in greased bowl, turning to grease top. Cover. Let rise in warm place, free from draft, about 15 minutes. Turn dough onto lightly floured surface. Shape as desired (see following suggestions). Cover. Let rise in slightly warm oven (90°F) about 15 minutes. Bake at 425°F for 12 minutes, or until golden brown. Remove from pans immediately and cool on wire racks.

Curlicues: Divide dough in half and roll each half to 12x9-inch rectangle. Cut 12 equal strips about 1 inch wide. Roll each strip tightly to form a coil, tucking ends underneath. Place on greased baking sheets about 2 inches apart.

Cloverleaves: Divide dough into 24 equal pieces. Form each piece into a ball and place in greased muffin pan. With scissors, cut each ball in half, then quarters.

Yield: 24 servings (1 roll per serving).

Per serving: About 130 cal, 4 g pro, 25 g carb, 2 g fat, 0 mg chol, 198 mg sod.

Whole Grain Wheat Bread

- ½ cup plus 1
tablespoon brown
sugar*
- 2 cups warm water
(105°F to 115°F)*
- 2 packages active
dry yeast*
- 5-6 cups whole wheat
flour*
- ¾ cup powdered milk*
- 2 teaspoons salt*
- ½ cup oil*

Dissolve 1 tablespoon brown sugar in warm water in small bowl. Add yeast and let mixture stand.

Place 4 cups flour, powdered milk, ½ cup brown sugar, and salt in mixer bowl. Attach bowl and PowerKnead™ Spiral Dough Hook to mixer. Turn to Speed 2 and mix about 15 seconds. Continuing on Speed 2, gradually add yeast mixture and oil to flour mixture and mix about 1½ minutes longer. Stop and scrape bowl, if necessary.

Continuing on Speed 2, add remaining flour, ½ cup at a time, and mix about 2 minutes, or until dough starts to clean sides of bowl. Knead on Speed 2 about 2 minutes longer.

NOTE: Dough may not form a ball on hook. However, as long as hook comes in contact with dough, kneading will be accomplished. Do not add more than the maximum amount of flour specified or a dry loaf will result.

Place dough in greased bowl, turning to grease top. Cover. Let rise in warm place, free from draft, about 1 hour, or until doubled in bulk.

Punch dough down and divide in half. Shape each half into a loaf as directed on page 55. Place in greased 8½x4½x2½-inch baking pan. Cover. Let rise in warm place, free from draft, about 1 hour, or until doubled in bulk.

Bake at 400°F for 15 minutes. Reduce oven temperature to 350°F and bake 20 to 30 minutes longer. Remove from pans immediately and cool on wire racks.

Yield: 32 servings (16 slices per loaf).

Per serving: About 112 cal, 4 g pro, 19 g carb, 3 g fat, 2 mg chol, 146 mg sod.

French Bread

- 2 packages active dry yeast
- 2½ cups warm water (105°F to 115°F)
- 1 tablespoon salt
- 1 tablespoon butter or margarine, melted
- 7 cups all-purpose flour
- 2 tablespoons cornmeal
- 1 egg white
- 1 tablespoon cold water

Dissolve yeast in warm water in warmed mixer bowl. Add salt, butter, and flour. Attach bowl and PowerKnead™ Spiral Dough Hook to mixer. Turn to Speed 2 and mix about 1 minute, or until well blended. Knead on Speed 2 about 2 minutes longer. Dough will be sticky.

Place dough in greased bowl, turning to grease top. Cover. Let rise in warm place, free from draft, about 1 hour, or until doubled in bulk.

Punch dough down and divide in half. Roll each half into 12x15-inch rectangle. Roll dough tightly, from longest side, tapering ends if desired. Place loaves on greased baking sheets that have been dusted with cornmeal. Cover. Let rise in warm place, free from draft, about 1 hour, or until doubled in bulk.

With sharp knife, make 4 diagonal cuts on top of each loaf. Bake at 450°F for 25 minutes. Remove from oven. Beat egg white and water together with a fork. Brush each loaf with egg mixture. Return to oven and bake 5 to 10 minutes longer. Remove from baking sheets immediately and cool on wire racks.

Yield: 30 servings (15 slices per loaf).

Per serving: About 114 cal, 3 g pro, 23 g carb, 1 g fat, 0 mg chol, 221 mg sod.

Honey Oatmeal Bread

1½ cups water
½ cup honey
½ cup butter or margarine
5½-6½ cups all-purpose flour
1 cup quick cooking oats
2 teaspoons salt
2 packages active dry yeast
2 eggs
1 egg white
1 tablespoon water
Oatmeal

Place water, honey, and butter in small saucepan. Heat over low heat until mixture is very warm (120°F to 130°F).

First place oats, then 5 cups flour, salt, and yeast in mixer bowl. Attach bowl and PowerKnead™ Spiral Dough Hook to mixer. Turn to Speed 2 and mix about 15 seconds. Continuing on Speed 2, gradually add warm mixture to flour mixture and mix about 1 minute. Add eggs and mix about 1 minute longer.

Continuing on Speed 2, add remaining flour, ½ cup at a time, and mix about 2 minutes, or until dough starts to clean sides of bowl. Knead on Speed 2 about 2 minutes longer.

Place dough in greased bowl, turning to grease top. Cover. Let rise in warm place, free from draft, about 1 hour, or until doubled in bulk.

Punch dough down and divide in half. Shape each half into a loaf as directed on page 55. Place in greased 8½x4½x2½-inch baking pans. Cover. Let rise in warm place, free from draft, about 1 hour, or until doubled in bulk.

Beat egg white and water together with a fork. Brush tops of loaves with mixture. Sprinkle with oatmeal. Bake at 375°F for 30 to 40 minutes. Remove from pans immediately and cool on wire racks.

Yield: 32 servings (16 slices per loaf).

Per serving: About 134 cal, 4 g pro, 24 g carb, 3 g fat, 13 mg chol, 162 mg sod.

Light Rye Bread

¼ cup honey
¼ cup light molasses
2 teaspoons salt
2 tablespoons butter or margarine
2 tablespoons caraway seed
1 cup boiling water
2 packages active dry yeast
¾ cup warm water (105°F to 115°F)
2 cups rye flour
3½-4 cups all-purpose flour

Place honey, molasses, salt, butter, caraway seed, and boiling water in small bowl. Stir until honey dissolves. Cool to lukewarm.

Dissolve yeast in warm water in warmed mixer bowl. Add lukewarm honey mixture, rye flour, and 1 cup all-purpose flour. Attach bowl and PowerKnead™ Spiral Dough Hook to mixer. Turn to Speed 2 and mix about 1 minute, or until well mixed. Stop and scrape bowl if necessary.

Continuing on Speed 2, add remaining all-purpose flour, ½ cup at a time, and mix about 2 minutes, or until dough starts to clean sides of bowl. Knead on Speed 2 about 2 minutes longer.

Place dough in greased bowl, turning to grease top. Cover. Let rise in warm place, free from draft, about 1 hour, or until doubled in bulk.

Punch dough down and divide in half. Shape each half into a round loaf. Place on two greased baking sheets. Cover. Let rise in warm place, free from draft, 45 to 60 minutes, or until doubled in bulk.

Bake at 350°F for 30 to 45 minutes. Cover loaves with aluminum foil for last 15 minutes if tops brown too quickly. Remove from baking sheets immediately and cool on wire racks.

Yield: 32 servings (16 slices per loaf).

Per serving: About 96 cal, 2 g pro, 20 g carb, 1 g fat, 0 mg chol, 143 mg sod.

Dill Batter Bread

- 2 *packages active dry yeast*
- ½ *cup warm water (105°F to 115°F)*
- 4 *tablespoons honey, divided*
- 2 *cups large curd cottage cheese*
- 2 *tablespoons grated fresh onion*
- 4 *tablespoons butter or margarine, softened*
- 3 *tablespoons dill seed*
- 3 *teaspoons salt*
- ½ *teaspoon baking soda*
- 2 *eggs*
- 1 *cup whole wheat flour*
- 3-3½ *cups all-purpose flour*

Dissolve yeast in warm water in warmed mixer bowl. Add 1 tablespoon honey and let stand 5 minutes.

Add cottage cheese, remaining 3 tablespoons honey, onion, butter, dill seed, salt, and soda. Attach bowl and flat beater to mixer. Turn to STIR Speed and mix about 30 seconds. Add eggs. Continuing on STIR Speed, mix about 15 seconds.

Add whole wheat flour and 2 cups all-purpose flour. Turn to Speed 2 and mix about 2 minutes, or until combined. Continuing on Speed 2, add remaining flour, a little at a time, and mix until dough forms a stiff batter. Stop and scrape bowl, if necessary. Continuing on Speed 2, mix about 2 minutes longer.

Cover. Let rise in warm place, free from draft, about 1 hour, or until doubled in bulk.

Stir dough down. Place in two well-greased 8½x4½x2½-inch baking pans or two well-greased 1½- to 2-quart casseroles. Cover. Let rise in warm place, free from draft, about 45 minutes, or until doubled in bulk.

Bake at 350°F for 40 to 50 minutes. Remove from pans immediately and cool on wire racks.

Yield: 32 servings (16 slices per loaf).

Per serving: About 98 cal, 4 g pro, 15 g carb, 3 g fat, 15 mg chol, 298 mg sod.

VARIATION

Dill Batter Bread for a Crowd

Double all ingredients and prepare in 6 quart mixer bowl.

Yield: 64 servings (16 slices per loaf).

Vegetable Cheese Bread

2 packages active dry yeast	Dissolve yeast in warm water in small bowl. Set aside.
1 cup warm water (105°F to 115°F)	
2 cups whole wheat flour	Combine whole wheat flour, 2 cups all-purpose flour, sugar, and salt in mixer bowl. Attach bowl and PowerKnead™ Spiral Dough Hook to mixer. Turn to Speed 2 and mix about 30 seconds.
3-3½ cups all-purpose flour	Continuing on Speed 2, gradually add yeast mixture, softened butter, and warm milk to flour mixture and mix about 1½ minutes. Stop and scrape bowl. Add tomatoes, onion, parsley, and cheese. Turn to Speed 2 and mix about 30 seconds.
2 tablespoons sugar	
2 teaspoons salt	
2 tablespoons softened butter or margarine	Continuing on Speed 2, add remaining flour, ½ cup at a time and mix about 2 minutes, or until dough starts to clean sides of bowl. Knead on Speed 2 about 2 minutes longer.
1 cup warm low-fat milk (105°F to 115°F)	
¼ cup chopped sun-dried tomatoes	Place dough in greased bowl, turning to grease top. Cover. Let rise in warm place, free from draft, about 1 hour, or until doubled in bulk.
2 teaspoons instant minced onion	
2 teaspoons dried parsley leaves	Punch dough down and divide in half. Shape each half into a loaf as directed on page 55. Place in well-greased 8½x4½x2½-inch baking pans. Cover. Let rise in warm place, free from draft, 45 to 60 minutes, or until doubled in bulk.
½ cup shredded sharp Cheddar cheese	Bake at 375°F for 40 minutes. Remove from pans immediately and cool on wire rack. (NOTE: Loaves may need to be released by running a knife around edges of pans.)
	Yield: 32 servings (16 slices per loaf).
	Per serving: About 99 cal, 3 g pro, 18 g carb, 2 g fat, 2 mg chol, 160 mg sod.

Blueberry Oat Bread

- 2 cups all-purpose flour
- 1 cup rolled oats
- 1 cup sugar
- 1½ teaspoons baking powder
- ½ teaspoon baking soda
- ¼ teaspoon salt
- ¼ teaspoon allspice
- ¾ cup low-fat milk
- ½ cup butter or margarine, melted
- 1 tablespoon grated orange peel
- 2 eggs
- 1¼ cups fresh or frozen blueberries (not thawed)

Combine dry ingredients in mixer bowl. Add milk, butter, orange peel, and eggs. Attach bowl and flat beater to mixer. Turn to STIR Speed and mix about 30 seconds. With spoon, gently stir in blueberries.

Spoon batter into 9x5x3-inch baking pan that has been greased on the bottom only. Bake at 350°F for 55 to 65 minutes, or until toothpick inserted in center comes out clean. Cool in pan 10 minutes. Remove from pan and cool completely on wire rack.

Yield: 16 servings (16 slices per loaf).

Per serving: About 196 cal, 3 g pro, 31 g carb, 7 g fat, 27 mg chol, 177 mg sod.

Baking Powder Biscuits

- 2 cups all-purpose flour
- 4 teaspoons baking powder
- ½ teaspoon salt
- ½ cup shortening
- ¾ cup low-fat milk
- Melted butter or margarine, if desired

Place flour, baking powder, salt, and shortening in mixer bowl. Attach bowl and flat beater to mixer. Turn to STIR Speed and mix about 1 minute. Stop and scrape bowl. Add milk. Continuing on STIR Speed, mix until dough starts to cling to beater. Avoid overbeating.

Turn dough onto lightly floured surface and knead about 20 seconds, or until smooth. Pat or roll to ½-inch thickness. Cut with floured 2-inch biscuit cutter.

Place on greased baking sheets and brush with melted butter, if desired. Bake at 450°F for 12 to 15 minutes. Serve immediately.

Yield: 12 servings (1 biscuit per serving).

Per serving: About 135 cal, 3 g pro, 17 g carb, 6 g fat, 1 mg chol, 183 mg sod.

Basic Sweet Dough

- ¾ cup low-fat milk*
- ½ cup sugar*
- 1¼ teaspoons salt*
- ½ cup butter or margarine*
- 2 packages active dry yeast*
- ½ cup warm water (105°F to 115°F)*
- 3 eggs, room temperature*
- 5½-6½ cups all-purpose flour*

Place milk, sugar, salt, and butter in small saucepan. Heat over low heat until butter melts and sugar dissolves. Cool to lukewarm.

Dissolve yeast in warm water in warmed mixer bowl. Add lukewarm milk mixture, eggs, and 5 cups flour. Attach bowl and PowerKnead™ Spiral Dough Hook to mixer. Turn to Speed 2 and mix about 2 minutes.

Continuing on Speed 2, add remaining flour, ½ cup at a time, and mix about 1½ minutes, or until dough starts to clean sides of bowl. Knead on Speed 2 about 2 minutes longer.

Place dough in greased bowl, turning to grease top. Cover. Let rise in warm place, free from draft, about 1 hour, or until doubled in bulk.

Punch dough down and shape as desired for rolls or coffee cakes.

VARIATION

Basic Sweet Dough for a Crowd

Double all ingredients and prepare in 6 quart mixer bowl. In first paragraph, change small saucepan to medium saucepan. In second paragraph, change 5 cups flour to 10 cups flour.

Cinnamon Swirl Rounds

- 1 cup firmly packed brown sugar
- 1 cup sugar
- ½ cup butter or margarine, softened
- ¼ cup all-purpose flour
- 1½ tablespoons cinnamon
- ½ cup chopped walnuts or pecans
- 1 recipe Basic Sweet Dough (see page 67)

Place brown sugar, sugar, butter, flour, cinnamon, and walnuts in mixer bowl. Attach bowl and flat beater to mixer. Turn to Speed 2 and mix about 1 minute.

Turn dough onto lightly floured surface. Roll dough to 10x24-inch rectangle. Spread sugar-cinnamon mixture evenly on dough. Roll dough tightly from long side to form 24-inch roll, pinching seam together. Cut into 24 slices, 1-inch each.

Place 12 rolls each in two greased 13x9x2-inch baking pans. Cover. Let rise in warm place, free from draft, 45 to 60 minutes, or until doubled in bulk.

Bake at 350°F for 20 to 25 minutes. Remove from pans immediately. Spoon **Caramel Glaze** over warm rolls.

Caramel Glaze

- ½ cup evaporated milk
- 2 tablespoons brown sugar
- 1½ cups powdered sugar
- 1 teaspoon vanilla

Place evaporated milk and brown sugar in small saucepan. Cook over medium heat until mixture begins to boil, stirring constantly.

Place milk mixture, powdered sugar, and vanilla in mixer bowl. Attach bowl and flat beater to mixer. Turn to Speed 4 and beat about 2 minutes, or until creamy.

Yield: 24 servings (1 roll per serving)

Per serving: About 338 cal, 6 g pro, 57 g carb, 10 g fat, 28 mg chol, 219 mg sod.

Rapid Mix Cool Rise White Bread

- 6-7 cups all-purpose flour
- 2 tablespoons sugar
- 3½ teaspoons salt
- 3 packages active dry yeast
- ¼ cup butter or margarine, softened
- 2 cups very warm water (120°F to 130°F)
- vegetable oil

Place 5½ cups flour, sugar, salt, yeast, and butter in mixer bowl. Attach bowl and PowerKnead™ Spiral Dough Hook to mixer. Turn to Speed 2 and mix about 20 seconds. Gradually add warm water and mix about 1½ minutes longer.

Continuing on Speed 2, add remaining flour, ½ cup at a time, and mix about 2 minutes, or until dough starts to clean sides of bowl. Knead on Speed 2 about 2 minutes longer.

Cover dough with plastic wrap and a towel. Let rest 20 minutes.

Divide dough in half. Shape each half into a loaf as directed on page 57. Place in greased 8½x4½x2½-inch baking pans. Brush each loaf with vegetable oil and cover loosely with plastic wrap. Refrigerate 2 to 12 hours.

When ready to bake, uncover dough carefully. Let stand at room temperature 10 minutes. Puncture any gas bubbles which may have formed.

Bake at 400°F for 35 to 40 minutes. Remove from pans immediately and cool on wire racks.

Yield: 32 servings (16 slices per loaf).

Per serving: About 110 cal, 3 g pro, 21 g carb, 2 g fat, 0 mg chol, 251 mg sod.

Crusty Pizza Dough

- 1 *package active dry yeast*
- 1 *cup warm water (105°F to 115°F)*
- $\frac{1}{2}$ *teaspoon salt*
- 2 *teaspoons olive oil*
- 2½-3½ *cups all-purpose flour*
- 1 *tablespoon cornmeal*

Dissolve yeast in warm water in warmed mixer bowl. Add salt, olive oil, and 2½ cups flour. Attach bowl and PowerKnead™ Spiral Dough Hook to mixer. Turn to Speed 2 and mix about 1 minute.

Continuing on Speed 2, add remaining flour, ½ cup at a time, and mix about 1½ minutes, or until dough starts to clean sides of bowl. Knead on Speed 2 about 2 minutes longer.

Place dough in greased bowl, turning to grease top. Cover. Let rise in warm place, free from draft, about 1 hour, or until doubled in bulk. Punch dough down.

Brush 14-inch pizza pan with oil. Sprinkle with cornmeal. Press dough across bottom of pan, forming a collar around edge to hold toppings. Add toppings, as desired. Bake at 450°F for 15 to 20 minutes.

Yield: 4 servings (¼ pizza per serving).

Per serving: About 373 cal, 11 g pro, 74 g carb, 3 g fat, 0 mg chol, 271 mg sod.

VARIATION

Pizza for a Crowd

Double the ingredients and prepare in the 6 quart mixer bowl.

Yield: 8 servings (¼ pizza per serving).

Herb Garlic Baguettes

- 1 *package active dry yeast*
- 1 *teaspoon sugar*
- $\frac{1}{4}$ *cup warm water (105°F to 115°F)*
- $3\frac{1}{4}$ - $3\frac{1}{2}$ *cups all-purpose flour*
- 1 *tablespoon chopped fresh basil or 1 teaspoon dried basil*
- 2 *teaspoons chopped fresh oregano or $\frac{1}{2}$ teaspoon dried leaf oregano*
- 2 *teaspoons chopped fresh thyme or $\frac{1}{2}$ teaspoon dried leaf thyme*
- 1 *teaspoon fresh minced garlic*
- 1 *teaspoon salt*
- $\frac{3}{4}$ *cup cold water*
- 1 *egg*
- 1 *teaspoon water*

Dissolve yeast and sugar in warm water.

Place $3\frac{1}{4}$ cups flour, basil, oregano, thyme, garlic, and salt in bowl. Attach bowl and PowerKnead™ Spiral Dough Hook to mixer. Turn to Speed 2 and mix 30 seconds. Stop and scrape bowl.

Continuing on Speed 2, slowly add yeast mixture and cold water, mixing about 30 seconds. If dough is sticky, add remaining $\frac{1}{4}$ cup flour. Knead on Speed 2 about 3 minutes, or until dough is smooth and elastic.

Place dough in greased bowl, turning to grease top. Cover. Let rise in warm place, free from draft, $1\frac{1}{2}$ to 2 hours, or until doubled in size.

On lightly floured surface, punch dough down several times to remove all air bubbles. Divide dough in half. Shape each half into a 12-inch long loaf. Place each loaf on greased baking sheet or in greased baguette pans. With sharp knife, make 3 to 4 shallow diagonal slices in top of dough. Beat egg and 1 teaspoon water together with a fork. Brush each baguette with egg mixture. Cover with greased plastic wrap. Let rise in warm place, free from draft, about 1 to $1\frac{1}{2}$ hours, or until doubled in bulk.

Brush top of each baguette again with egg mixture. Bake at 450°F for 15 to 18 minutes, or until deep golden brown. Remove from pans and cool on wire racks.

Yield: 36 servings (18 slices per loaf).

Tip: Freeze up to 2 weeks. Thaw at room temperature. Wrap loosely with foil. Heat at 375°F for 10 to 15 minutes.

Per serving: About 45 cal, 1 g pro, 9 g carb, 0 g fat, 6 mg chol, 62 mg sod.

Herb Pull-Apart Rolls

- 1 package active dry yeast
- 1 cup warm water (105°F to 115°F)
- ½ cup butter or margarine, melted
- 3-3½ cups all-purpose flour
- 2 tablespoons sugar
- 1½ teaspoons salt
- ¼ teaspoon thyme
- ¼ teaspoon oregano
- ¼ teaspoon dill

Dissolve yeast in warm water in warmed mixer bowl. Add ¼ cup butter, 2 cups flour, sugar, salt, thyme, oregano, and dill. Attach bowl and PowerKnead™ Spiral Dough Hook to mixer. Turn to Speed 2 and mix for 1 minute, or until well blended.

Continuing on Speed 2, add remaining flour, ½ cup at a time, and mix about 2 minutes, or until dough starts to clean sides of bowl. Knead on Speed 2 about 2 minutes longer, or until dough is smooth and elastic.

Place dough in greased bowl, turning to grease top. Cover. Let rise in warm place, free from draft, about 1 hour, or until doubled in bulk.

Punch dough down. Roll dough into a 12x9x¼-inch rectangle. Brush with remaining butter. Slice dough into six 1½x12-inch strips. Stack strips; then cut into twelve 1-inch pieces. Place pieces, cut side up, in greased muffin pans. Cover. Let rise in warm place, free from draft, about 45 minutes, or until doubled in bulk. Bake at 400°F for 15 to 20 minutes.

Remove from pans immediately and cool on wire racks.

Yield: 12 servings (12 rolls).

Per serving: About 149 cal, 3 g pro, 17 g carb, 8 g fat, 20 mg chol, 292 mg sod.

Banana Nut Bread

- ½ cup shortening*
- ½ cup sugar*
- 2 eggs*
- 1¾ cups all-purpose flour*
- 1 teaspoon baking powder*
- ½ teaspoon baking soda*
- ½ teaspoon salt*
- 1 cup (2 medium) mashed ripe banana*
- ½ cup chopped walnuts or pecans*

Place shortening and sugar in mixer bowl. Attach bowl and flat beater to mixer. Turn to Speed 6 and beat about 1 minute. Stop and scrape bowl. Continuing on Speed 6, beat about 1 minute longer. Add eggs. Turn to Speed 4 and beat about 30 seconds. Stop and scrape bowl. Turn to Speed 6 and beat about 1½ minutes.

Combine flour, baking powder, baking soda, and salt in separate bowl. Add half of flour mixture and half of mashed banana to mixer bowl. Turn to STIR Speed and mix about 30 seconds. Add remaining flour and banana. Continuing on STIR Speed, mix about 30 seconds. Stop and scrape bowl. Add walnuts. Continuing on STIR Speed, mix about 15 seconds.

Pour mixture into greased and floured 9x5x3-inch baking pan. Bake at 350°F for 40 to 45 minutes. Cool 5 minutes in pan. Remove from pan and cool completely on wire rack.

Yield: 16 servings (16 slices).

Per serving: About 157 cal, 3 g pro, 21 g carb, 7 g fat, 27 mg chol, 131 mg sod.

VARIATION

Bread for Gifts

Triple the ingredients to prepare 3 loaves for gift-giving.

Yield: 48 servings (16 slices per loaf).

Lemony Raisin Bread

- 1 package active dry yeast
- 1 cup warm milk (105°F to 115°F)
- 4 to 4½ cups all-purpose flour
- 1 cup raisins
- ¼ cup sugar
- 1 teaspoon salt
- 1 teaspoon grated lemon peel
- ½ cup vegetable oil
- ½ cup butter or margarine, melted
- 4 egg yolks, beaten
- 1 egg white
- 1 tablespoon water

Dissolve yeast in warm milk. Set aside.

Place 3 cups flour, raisins, sugar, salt, and lemon peel in mixing bowl. Attach bowl and PowerKnead™ Spiral Dough Hook to mixer. Turn to Speed 2 and mix about 15 seconds.

Continuing on Speed 2, gradually add milk mixture, oil, butter, and egg yolks to flour mixture and mix about 1 minute.

Continuing on Speed 2, add remaining flour, ½ cup at a time, until dough starts to clean sides of bowl. Knead on Speed 2 about 2 minutes longer.

(NOTE: Dough may not form a ball on the hook. However, as long as there is contact between dough and hook, kneading will be accomplished. Do not add more than the maximum amount of flour specified or loaf will be dry.)

Place dough in a greased bowl, turning to grease top. Cover. Let rise in warm place, free from draft, about 1 hour, or until doubled in bulk.

Punch dough down and shape into a ball. Place in a greased and floured 1½-quart baking dish. Let rise in warm place, free from draft, about 1 hour, or until doubled in bulk.

Cut 2 slashes with a sharp knife in a cross pattern on top of loaf. Beat egg white and water in small bowl and brush lightly on top of loaf. Bake at 350°F for 55 to 60 minutes. Remove from baking dish immediately and cool on wire rack.

Yield: 12 servings (12 slices per loaf).

Per serving: About 351 cal, 7 g pro, 47 g carb, 15 g fat, 83 mg chol, 253 mg sod.

VARIATION

Lemony Raisin Focaccia

Prepare dough as directed above. After shaping into a ball, place dough on lightly greased baking sheet and flatten to 2 inches thick. Let rise and bake as directed above.

Raisin Bran Muffins

- 1 cup boiling water
- 1 cup wheat bran
- 1 cup raisins
- 1 cup brown sugar
- ½ cup sugar
- ½ cup shortening
- 2 eggs
- 2 cups buttermilk
- 1½ teaspoons vanilla
- 2½ cups all-purpose flour
- 2½ teaspoons baking soda
- 1 teaspoon baking powder
- ½ teaspoon salt
- 2 cups bran cereal flakes

Pour boiling water over bran in medium bowl. Add raisins. Set aside.

Place brown sugar, sugar, and shortening in mixer bowl. Attach bowl and flat beater to mixer. Turn to Speed 4 and beat about 1 minute. Add eggs. Turn to Speed 4 and beat about 30 seconds. Add buttermilk and vanilla. Turn to STIR Speed and mix about 30 seconds. Stop and scrape bowl.

Add flour, baking soda, baking powder, and salt. Continuing on STIR Speed, mix about 30 seconds. Stop and scrape bowl. Continuing on STIR Speed, mix about 30 seconds longer. Gradually turn to Speed 4 and beat about 1 minute. Add bran-raisin mixture and bran cereal flakes. Turn to STIR Speed and mix about 30 seconds, or until ingredients are combined.

Spoon batter into greased or paper-lined muffin pans. Bake at 400°F for 20 minutes, or until toothpick inserted in center comes out clean. Remove from pans immediately. Serve warm.

Yield: 24 servings (1 muffin per serving).

Per servings; About 185 cal, 3 g pro, 33 g carb, 5 g fat, 18 mg chol, 261 mg sod.

Tip: Batter can be refrigerated in tightly covered container up to 1 week.

Pepper Cheese Muffins

- 1 cup buttermilk
- ½ cup butter or margarine, melted
- 2 eggs
- 2 cups all-purpose flour
- 4 oz. (1 cup) shredded pepper cheese
- 1 tablespoon sugar
- 2 teaspoons baking powder
- 1 teaspoon chopped parsley
- ½ teaspoon baking soda
- ¼ teaspoon salt
- ¼ teaspoon coarsely ground black pepper

Place buttermilk, butter, and eggs in bowl. Attach bowl and flat beater to mixer. Turn to Speed 4 and beat 1 minute. Stop and scrape bowl. Combine flour, cheese, sugar, baking powder, parsley, baking soda, salt, and pepper. Turn to STIR Speed and add flour mixture, mixing just until moistened, about 30 seconds. DO NOT OVER BEAT.

Fill greased regular muffin pans two-thirds full. Bake at 400°F for 15 to 20 minutes. Serve warm.

Yield: 12 servings (12 muffins).

Tip: Recipe will make 24 miniature muffins to serve as an appetizer.

Per serving: About 90 cal, 3 g pro, 9 g carb, 5 g fat, 29 mg chol, 145 mg sod.

VARIATION

Muffins for a Party

Double all ingredients and prepare in 6 quart mixer bowl. In first paragraph, change Speed 4 to Speed 2.

Yield: 24 servings (24 muffins).

Sour Cream Coffee Cake

- ½ cup firmly packed brown sugar*
- 1½ teaspoons cinnamon*
- 1 cup chopped walnuts or pecans*
- 3 cups all-purpose flour*
- 1½ cups granulated sugar*
- 3 teaspoons baking powder*
- 1 teaspoon baking soda*
- ½ teaspoon salt*
- 1 cup butter or margarine, softened*
- 1 cup reduced-fat sour cream*
- 1 teaspoon vanilla*
- 3 eggs*

Combine brown sugar, cinnamon, and walnuts in small bowl. Set aside.

Combine flour, granulated sugar, baking powder, baking soda, and salt in mixer bowl. Add butter, sour cream, and vanilla. Attach bowl and flat beater to mixer. Turn to Speed 2 and mix about 45 seconds, or until ingredients are combined. Stop and scrape bowl. Turn to Speed 4 and beat about 1½ minutes. Stop and scrape bowl.

Turn to STIR Speed and add eggs, one at a time, mixing about 15 seconds after each addition. Turn to Speed 2 and mix about 30 seconds.

Spread half of batter in greased and floured 13x9x2-inch baking pan or 10-inch tube pan. Sprinkle with half of cinnamon-sugar mixture. Spread remaining batter in pan and top with remaining cinnamon-sugar mixture. Bake at 350°F for 40 to 50 minutes (13x9x2-inch pan) or 50 to 60 minutes (10-inch tube pan). Serve warm.

Yield: 16 servings.

Per serving: About 362 cal, 6 g pro, 47 g carb, 17 g fat, 44 mg chol, 349 mg sod.

VARIATION

Coffee Cake for a Crowd

Double the ingredients and prepare in 6 quart mixer bowl.

Yield: 32 servings (16 servings per cake).

Caramel Apple Kuchen

- 1 *recipe Basic Sweet Dough (see page 67)*
- 2 *cups firmly packed brown sugar*
- 6 *tablespoons all-purpose flour*
- 2 *teaspoons cinnamon*
- 6 *tablespoons butter or margarine, softened*
- 6-8 *apples (8 cups), peeled and thinly sliced*

Divide dough in half. Press each half into greased 13x9x2-inch baking pan. Gently press edges $\frac{1}{2}$ inch up sides.

Cover. Let rise in warm place, free from draft, 45 to 60 minutes, or until doubled in bulk.

Meanwhile, place brown sugar, flour, cinnamon, and butter in mixer bowl. Attach bowl and flat beater to mixer. Turn to Speed 2 and mix about 1 minute.

Arrange apple slices over dough in each of two pans. Sprinkle evenly with brown sugar mixture. Bake at 350°F for 35 to 45 minutes, or until golden brown and apples are tender. Serve warm.

Yield: 24 servings (12 pieces per kuchen).

Per serving: About 301 cal, 5 g pro, 54 g carb, 8 g fat, 27 mg chol, 207 mg sod.

Crispy Waffles

- 2 *cups all-purpose flour*
- 3 *teaspoons baking powder*
- 2 *tablespoons sugar*
- $\frac{1}{2}$ *teaspoon salt*
- 2 *eggs, separated*
- 1 $\frac{1}{4}$ *cups low-fat milk*
- $\frac{1}{4}$ *cup butter or margarine, melted*

Combine flour, baking powder, sugar, and salt in mixer bowl. Add egg yolks, milk, and butter. Attach bowl and flat beater to mixer. Turn to Speed 4 and mix about 30 seconds, or until ingredients are combined. Stop and scrape bowl. Continuing on Speed 4, mix about 15 seconds, or until smooth. Pour mixture into another bowl. Clean mixer bowl.

Place egg whites in mixer bowl. Attach bowl and wire whip to mixer. Turn to Speed 8 and whip until whites are stiff but not dry. Gently fold egg whites into flour mixture.

Spray waffle iron with no-stick cooking spray. Heat waffle iron. Pour about $\frac{1}{2}$ cup batter for each waffle onto iron. Bake 3 to 5 minutes, or until golden brown.

Yield: 6 servings (1 waffle per serving).

Per serving: About 287 cal, 8 g pro, 39 g carb, 10 g fat, 75 mg chol, 441 mg sod.

Light and Fluffy Pancakes

4 *eggs, separated*
1 *cup cottage cheese*
 $\frac{1}{2}$ *cup all-purpose flour*
 $\frac{1}{4}$ *teaspoon salt*

Place egg whites in mixer bowl. Attach bowl and wire whip to mixer. Turn to Speed 8 and beat 2 to 2½ minutes, or until egg whites are stiff but not dry. Place egg whites in another bowl.

Place yolks in mixer bowl. Turn to Speed 2 and mix about 1 minute. Continuing on Speed 2, add cottage cheese, flour, and salt. Mix about 1 minute. Stop and scrape bowl. Remove bowl from mixer and fold in beaten egg whites with a rubber spatula.

For each pancake, drop a heaping tablespoonful of batter on hot, greased griddle. Cook pancakes 1 to 2 minutes, or until puffed and dry around edges. Turn and cook 1 to 2 minutes longer, or until golden brown on underside.

Yield: 6 servings (3, 3-inch pancakes per serving).

Per serving: About 108 cal, 10 g pro, 7 g carb, 4 g fat, 147 mg chol, 272 mg sod.

Multi-Function Attachment Pack



Model FPPA

Three popular KitchenAid® attachments have been packaged in one carton. It includes a Rotor Slicer/Shredder (RVSA), Food Grinder (FGA), and Fruit/Vegetable Strainer Parts (FVSP).

Food Grinder



Model FGA

Grinds meat, firm fruits and vegetables, and dry bread.

Fruit/Vegetable Strainer



Model FVSFGA

Makes preparing jams, purées, sauces and baby foods quick and easy. Comes with Food Grinder.

Food Tray

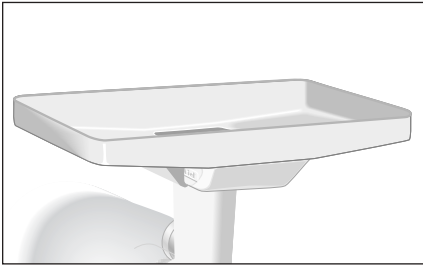

Model FT

Holds large quantities of food for quicker and easier juicing, puréeing and grinding. For use with FGA.

Sausage Stuffer



Model SSA

$\frac{3}{8}$ " and $\frac{5}{8}$ " stuffing tubes make Bratwurst, Kielbasa, Italian or Polish Sausage and breakfast links. For use with FGA.

Rotor Slicer/Shredder



Model RVSA

Includes 4 cones: thin and thick slicer, fine and coarse shredder.

Grain Mill



Model GMA

Grinds low-moisture grains from very fine to extra coarse textures.

Can Opener



Model CO

Opens cans quickly, leaves edges smooth and snag-free.

Pasta Roller Set



Model KPRA

Makes lasagna noodles, fettuccini and linguine fini. 3 piece set includes Roller, Fettuccine Cutter and Linguine Fini Cutter.

Citrus Juicer



Model JE

Juices citrus fruits quickly and thoroughly, strains out pulp.

Pasta Maker



Model SNFGA

5 plates make thin and thick spaghetti, flat noodles, macaroni, and lasagna. Comes with Food Grinder.

Pouring Shields



Model KPS2CL
(fits all 5-quart bowl-lift models
except the 5-quart KV models)
Minimizes splash-out when adding
ingredients.



Model KN2PS
(fits all 6-quart and KV 5-quart
bowl-lift models)
Minimizes splash-out when adding
ingredients.



FOR THE WAY IT'S MADE.™

® Registered trademark/™ Trademark/
the shape of the mixer is a trademark of KitchenAid, U.S.A.