

Standard cylinders DSNU/DSNUP/DSN/ESNU/ESN, ISO 6432



**Standard cylinders DSNU/DSNUP/DSN/ESNU/ESN, ISO 6432**

Key features

**At a glance**



ISO 6432  
DIN ISO 6432



- Round cylinders with piston diameters from 8 to 25 mm conform to ISO 6432, DIN ISO 6432. Variants are based on these standards
- The series is not repairable
- Stainless steel piston rod
- The cap is swaged onto the barrel

**Wide choice of variants**

**DSNU-...**

- Cylinder barrel made of stainless steel
- Bearing and end caps made of wrought aluminium alloy



**DSNUP-...**

- Cylinder barrel made of wrought aluminium alloy
- Bearing and end caps made of polyamide
- Cost optimised



**DSNU/ESNU-...MA**

- Threaded bearing cap
- Short end cap with axial supply port



**DSNU-...MQ**

- Threaded bearing cap
- Short end cap with lateral supply port



**DSNU-...MH**

- Direct mounting on bearing cap
- Short end cap with lateral supply port



**DSNU-...KP**

- With clamping unit



**DSNU-...Q**

- With square piston rod













**Cushioning types**

	Cushioning P	Cushioning PPS	Cushioning PPV
<b>Mode of operation</b>	<ul style="list-style-type: none"> <li>• The drive is fitted with flexible polymer end position cushioning</li> </ul>	<ul style="list-style-type: none"> <li>• The drive is fitted with self-adjusting end position cushioning</li> </ul>	<ul style="list-style-type: none"> <li>• The drive is fitted with adjustable end position cushioning</li> </ul>
<b>Application</b>	<ul style="list-style-type: none"> <li>• Small loads</li> <li>• Low speeds</li> <li>• Low impact energy</li> </ul>	<ul style="list-style-type: none"> <li>• Small to medium loads</li> <li>• Low to medium speeds</li> <li>• Medium impact energy</li> </ul>	<ul style="list-style-type: none"> <li>• Medium to large loads</li> <li>• High speeds</li> <li>• High impact energy</li> </ul>
<b>Advantages</b>	<ul style="list-style-type: none"> <li>• No adjustment required</li> <li>• Time-saving</li> </ul>	<ul style="list-style-type: none"> <li>• No adjustment required</li> <li>• Time-saving</li> <li>• Powerful</li> </ul>	<ul style="list-style-type: none"> <li>• Very powerful</li> </ul>

## Standard cylinders DSNU/DSNUP/DSN/ESNU/ESN, ISO 6432

**FESTO**

Key features

Additional variants		
Symbol	Key features	Description
	S2 Through piston rod	For working at both ends with the same force in the advance and return stroke, for attaching external stops
	S6 Heat resistant seals	Temperature resistance up to max. 120 °C
	S10 Constant (slow speed) operation at low piston speeds	Suitable for slow stroke movements at a constant, stick-slip-free speed over the full stroke of the cylinder. Seal contains silicone grease (not free of paint-wetting impairment substances)
	S11 Low friction	The special seals considerably reduce system wear. This corresponds to a considerably lower response pressure. Seal contains silicone grease (not free of paint-wetting impairment substances)
	K2 Extended male piston rod thread	–
	K3 Female piston rod thread	–
	K5 Special thread on piston rod	Metric standard thread to ISO
	K6 Shortened male piston rod thread	–
	K8 Extended piston rod	–
	R3 High corrosion protection	All external cylinder surfaces comply with corrosion resistance class 3 to Festo standard 940 070. The piston rod is made from corrosion and acid resistant steel

### Longer service life with bellows kit DADB



The bellows kit is a leak-free system. To prevent unwanted media from being drawn in, the supply and exhaust air of the kit must be ducted via a venting hole in the connection section 1.

The kit protects the piston rod, seal and bearing against a wide variety of media, for example:

- dust
- chippings
- oil
- grease
- fuel

## Standard cylinders DSNU/DSNUP/DSN, ISO 6432

Product range overview

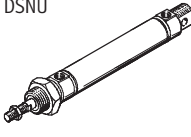
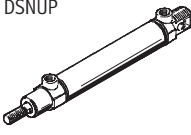
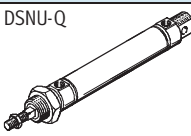
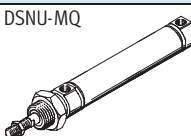
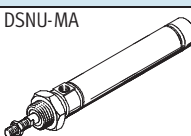
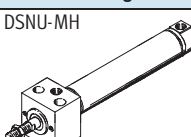
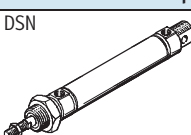
Function	Version	Piston Ø [mm]	Stroke [mm]	Variable stroke <sup>1)</sup> [mm]	Piston rod						
					Through S2	Extended K8	Male thread			Female thread K3	
							Extended K2	Shortened K6	Special thread K5		
Double-acting	<b>Basic version with position sensing (cylinder barrel made of stainless steel)</b>										
		DSNU	8, 10	10, 25, 40, 50,	1 ... 100	■	■	■	■	■	■
			12, 16	80, 100, 125,	1 ... 200						
			20	160, 200, 250,	1 ... 320						
			25	300, 320, 400, 500	1 ... 500						
	<b>Basic version with or without position sensing (cylinder barrel made of aluminium)</b>										
		DSNUP	16	25, 50, 100	2)	-	-	-	-	-	-
			20								
			25								
	<b>Protected against rotation</b>										
		DSNU-Q	12, 16	-	5 ... 160	■	■	■	■	■	■
			20	-	5 ... 200						
		25	-	5 ... 250							
<b>Lateral air connection</b>											
	DSNU-MQ	8, 10	-	1 ... 100	-	■	■	■	■	■	
		12, 16	-	1 ... 200							
		20	-	1 ... 320							
		25	-	1 ... 500							
<b>Axial air connection</b>											
	DSNU-MA	8, 10	-	1 ... 100	-	■	■	■	■	■	
		12, 16	-	1 ... 200							
		20	-	1 ... 320							
		25	-	1 ... 500							
<b>Direct mounting</b>											
	DSNU-MH	8, 10	-	1 ... 100	-	■	■	■	■	■	
		12, 16	-	1 ... 200							
		20	-	1 ... 320							
		25	-	1 ... 500							
<b>Basic version without position sensing</b>											
	DSN	8, 10	10, 25, 40, 50,	1 ... 100	■	-	-	-	-	-	
		12, 16	80, 100, 125,	1 ... 200							
		20	160, 200, 250,	1 ... 320							
		25	300, 320, 400, 500	1 ... 500							

1) Cylinders with position sensing require a minimum stroke of 10 mm to ensure reliable sensing

2) Variable stroke on request

# Standard cylinders DSNU/DSNUP/DSN, ISO 6432

Product range overview

Version	Cushioning			Position sensing	Clamping unit	Heat-resistant seal	Slow speed (constant motion operation)	Low friction	Corrosion protection	→ Page/ Internet
	Fixed	Adjustable	Self-adjusting							
	P	∅ 16 and above PPV <sup>2)</sup>	∅ 16 and above PPS	A	KP	S6	S10	S11	R3	
<b>Basic version with position sensing (cylinder barrel made of stainless steel)</b>										
DSNU	■	■	■	■	■	■	■	■	■	12
<b>Basic version with or without position sensing (cylinder barrel made of aluminium)</b>										
DSNUP	■	-	-	■	-	-	-	-	-	21
<b>Protected against rotation</b>										
DSNU-Q	■ ∅ 12	■ ∅ 16 ... 25	-	■	■	-	-	-	■ ∅ 12 ... 25	24
<b>Lateral air connection</b>										
DSNU-MQ	■	■	■	■	■	■	-	-	■	12
<b>Axial air connection</b>										
DSNU-MA	■	-	-	■	■	■	-	-	■	12
<b>Direct mounting</b>										
DSNU-MH	■	■	-	■	-	■	-	-	■	12
<b>Basic version without position sensing</b>										
DSN	■	■	-	-	-	-	-	-	-	44

2) In the modular product system from ∅ 12 mm

# Standard cylinders ESNU/ESN, ISO 6432

Product range overview

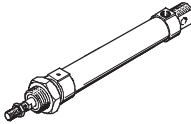
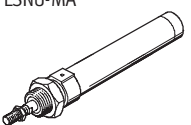
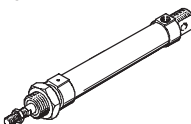
Function	Version	Piston∅	Stroke	Variable stroke <sup>1)</sup>	Cushioning Fixed	Position sensing
		[mm]	[mm]	[mm]	P	A
Single- acting	<b>Basic version with position sensing</b>					
	ESNU 	8, 10, 12, 16, 20, 25	10, 25, 50	1 ... 50	■	■
	<b>Axial air connection</b>					
	ESNU-MA 	8, 10, 12, 16, 20, 25	–	1 ... 50	■	■
	<b>Basic version without position sensing</b>					
	ESN 	8, 10, 12, 16, 20, 25	10, 25, 50	1 ... 50	■	–

1) Cylinders with position sensing require a minimum stroke of 10 mm to ensure reliable sensing

# Standard cylinders ESNU/ESN, ISO 6432

Product range overview

Version	Piston rod					→ Page/Internet
	Extended K8	Male thread			Female thread K3	
		Extended K2	Shortened K6	Special thread K5		
<b>Basic version with position sensing</b>						
ESNU	■	■	■	■	■	36
<b>Axial air connection</b>						
ESNU-MA	■	■	■	■	■	36
<b>Basic version without position sensing</b>						
ESN	-	-	-	-	-	50

# Standard cylinders DSNU/DSNUP/DSN/ESNU/ESN, ISO 6432

Peripherals overview

FESTO

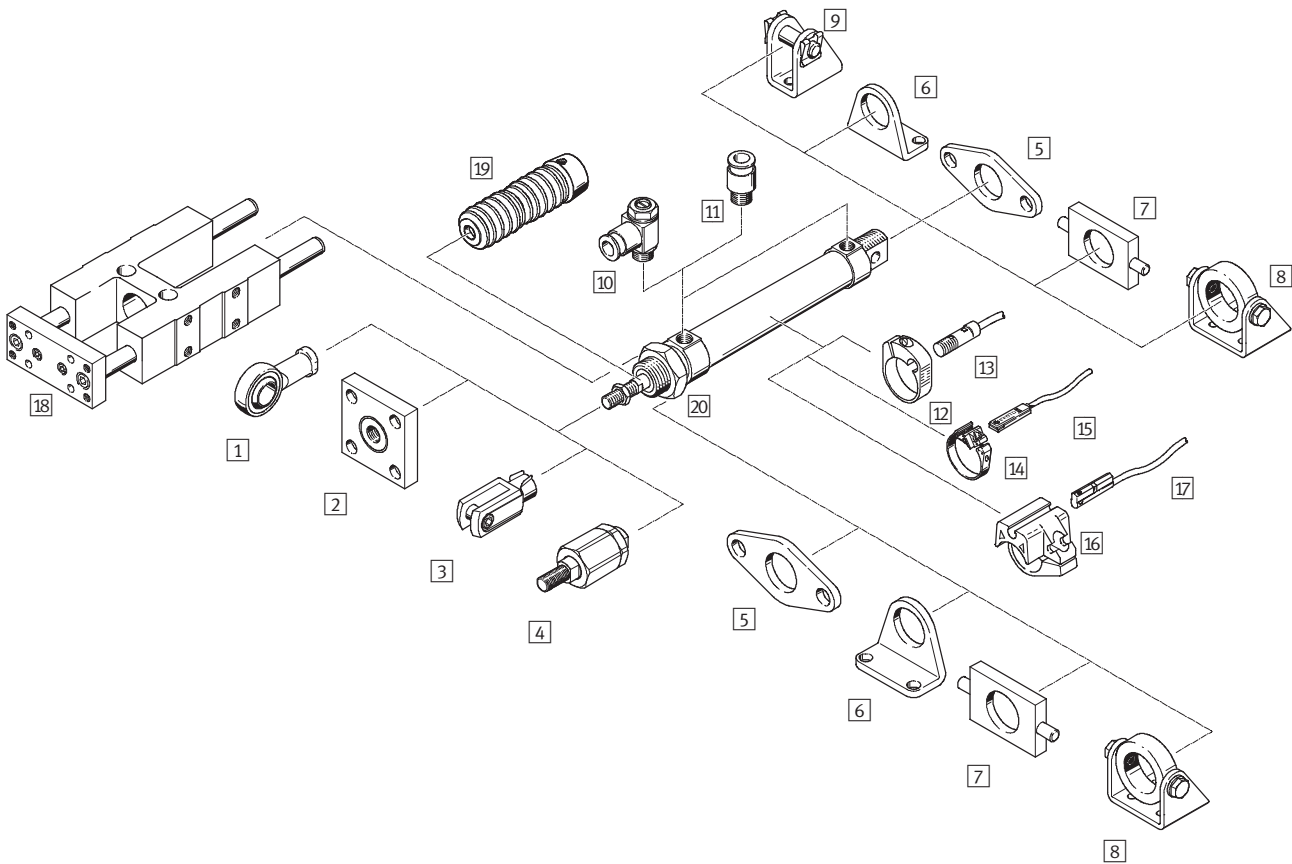

## Variants

DSNU-MQ

DSNU-MA

DSNU-MH

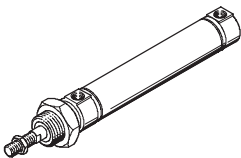

DSNU-Q

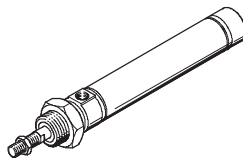

DSNU-KP

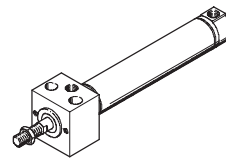

## Mounting options

Mounting front and rear

Mounting with hex nut

Swivel mounting

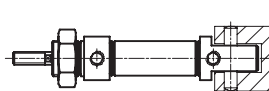
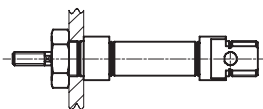
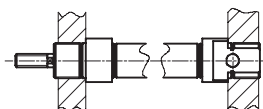

## Installation variants with mounting attachments

Foot mounting (for short strokes)

Foot mounting

Flange mounting

Swivel mounting

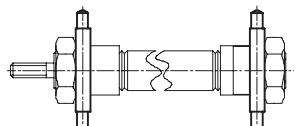
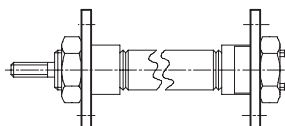
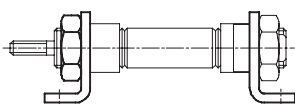
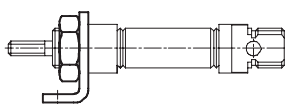



# Standard cylinders DSNU/DSNUP/DSN/ESNU/ESN, ISO 6432

Peripherals overview

Mounting attachments and accessories									
	DSNU/ ESNU	DSNUP	DSNU/ ESNU	DSNU			DSNU-Q	DSN/ESN	→ Page/Internet
			MA	MQ	MH	KP			
1	Rod eye SGS/CRSGS	■	■	■	■	■	■	■	57
2	Coupling piece KSG/KSZ	■	■	■	■	■	■	■	57
3	Rod clevis SG/CRSG	■	■	■	■	■	■	■	57
4	Self-aligning rod coupler FK	■	■	■	■	■	■	■	57
5	Flange mounting FBN/CRFBN	■	■	■	■	-	■	■	55
6	Foot mounting HBN/CRHBN	■	■	■	■	-	■	■	54
7	Swivel mounting <sup>1)</sup> WBN	■	■	■	■	-	■	■	56
8	Swivel mounting <sup>1)</sup> SBN	■	-	■	■	-	■	■	55
9	Clevis foot LBN/CRLBN	■	■	-	-	-	■	■	56
10	One-way flow control valve <sup>2)</sup> GRLA/GRLZ/CRGRLA	■	■	■	■	■	■	■	65
11	Push-in fitting <sup>2)</sup> QS	■	■	■	■	■	■	■	quick star
12	Mounting kit SMBR/CRSMBR	■	-	■	■	■	■	-	62
13	Proximity sensor SMEO/SMT0/CRSMEO-4	■	-	■	■	■	■	-	62
14	Mounting kit SMBR-8	■	■	■	■	■	■	-	63
15	Proximity sensor SME/SMT-8	■	■	■	■	■	■	-	63
16	Mounting kit SMBR-10	■	-	■	■	■	■	-	64
17	Proximity sensor SME/SMT-10	■	-	■	■	■	■	-	64
18	Guide unit FEN	■	-	■	■	-	-	■	57
19	Bellows kit <sup>3)</sup> DADB	■	-	■	■	-	-	-	58
20	Hex nut MSK	■	-	■	■	■	■	■	57

 Note

- |   |   |   |   |
|---|---|---|---|
| <p>1) Cannot be used on the bearing cap in combination with bellows kit DADB.</p> | <p>2) Only push-in fittings or one-way flow control valves with cylindrical connecting thread (M or G thread) may be used for the compressed air ports in conjunction with the DSNUP.</p> | <p>3) The bellows kit protects the cylinder (piston rod, seal and bearings) against a wide range of media and thus prevents premature wear.</p> | <p>It can only be used in combination with an extended piston rod (K8).</p> |
|---|---|---|---|

# Standard cylinders DSNU/DSNUP/DSN/ESNU/ESN, ISO 6432

FESTO

Type codes

DSNU – 25 – 80 – PPV – A – MQ

Type	
Double-acting	
DSNU/DSN	Standard cylinder
Single-acting	
ESNU/ESN	Standard cylinder
Piston Ø [mm]	
Stroke [mm]	
Cushioning	
P	Flexible cushioning rings/pads at both ends
PPV	Pneumatic cushioning, adjustable at both ends
PPS	Pneumatic cushioning, self-adjusting at both ends
Position sensing	
A	Via proximity sensor
Variant	
MQ	Lateral air connection
MA	Axial air connection
MH	With mounting flange on bearing cap
CT	Free of copper, PTFE and silicone

## Modular product system

Individually configurable

DSNU → 32

ESNU → 42

- Square piston rod (protection against rotation)
- Through piston rod (piston rod type)
- Extended male piston rod thread
- Male piston rod thread, shortened at one end
- Female piston rod thread (female thread)
- Special piston rod thread (special thread)
- Extended piston rod at front
- Clamping unit on the piston rod
- Heat-resistant seals for temperatures up to 120 °C (temperature resistance)
- Slow speed (constant motion at low piston rod speeds)
- Low friction
- All external cylinder surfaces conform to corrosion resistance class CRC 3 (corrosion protection)

# Standard cylinders DSNU/DSNUP/DSN/ESNU/ESN, ISO 6432

Type codes

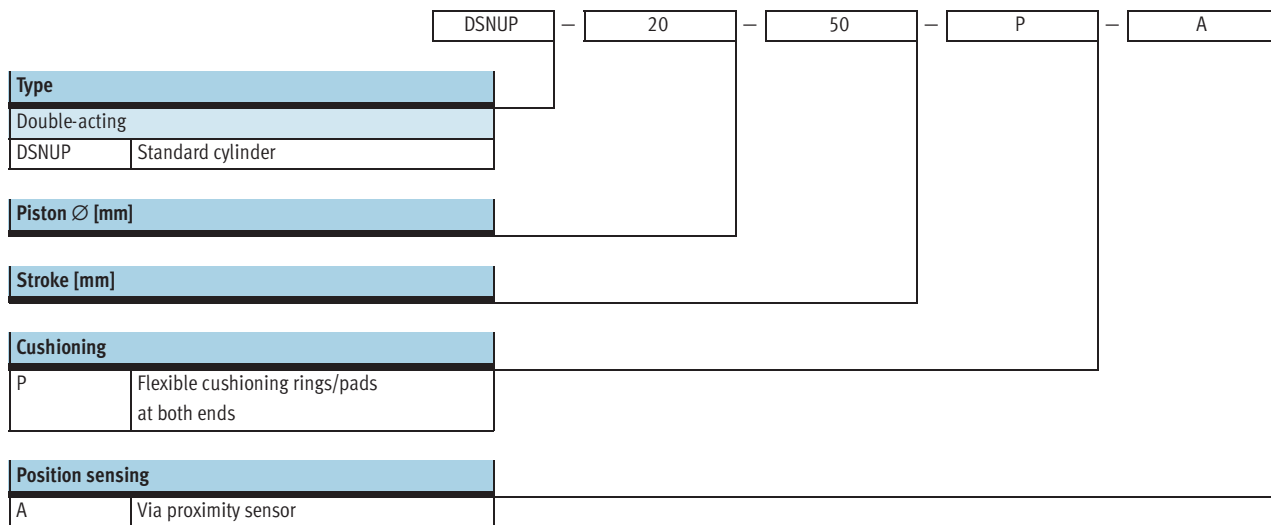

# Standard cylinders DSNU, ISO 6432

FESTO

Technical data

## Function

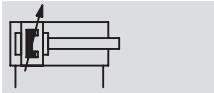
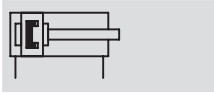

Ø - Diameter  
8 ... 25 mm

— - Stroke length  
1 ... 500 mm

## Variant

CT-free

## Additional variants

→ 17

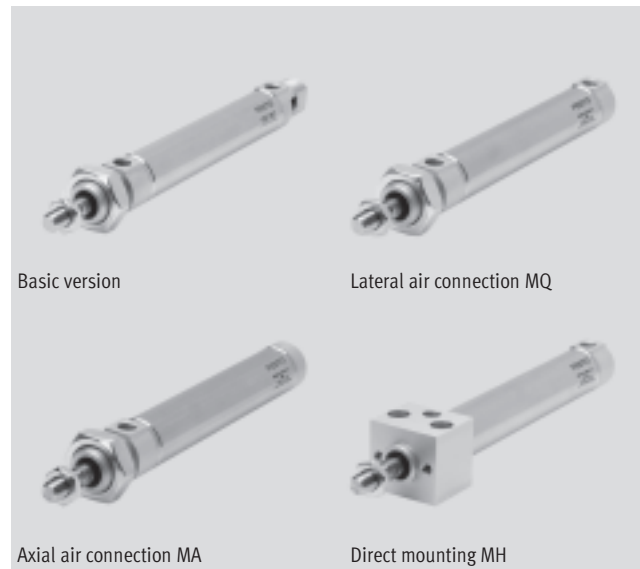

General technical data						
Piston Ø	8		10		25	
Pneumatic connection	M5		M5		G1/8	
Piston rod thread	M4		M4		M8	
Constructional design	Piston					
	Piston rod					
	Cylinder barrel					
Cushioning	P Flexible cushioning rings/pads at both ends					
	PPV – Adjustable cushioning at both ends					
	PPS – Self-adjusting cushioning at both ends					
Cushioning length	PPV	[mm]	9		12	15
	PPS	[mm]	–		12	15
Position sensing	Via proximity sensor					
Type of mounting	Direct mounting (MH variant only)					
	Via accessories					
Mounting position	Any					

|| - Note: This product conforms with the ISO 1179-1 standard and the ISO 228-1 standard.

Operating conditions						
Piston Ø	8		10		25	
Operating medium	Filtered compressed air, lubricated or unlubricated					
Operating pressure	Basic version	[bar]	1.5 ... 10 <sup>1)</sup>		1 ... 10	
	S10	–	1.5 ... 10		1 ... 10	
	S11	–	0.45 ... 10		0.3 ... 10	

1) With DSNU-12-...-PPV (pneumatic cushioning adjustable at both ends): 2 ... 10 bar

Ambient conditions						
Standard cylinder	Basic version	CT	S6	S10	S11	R3
Ambient temperature <sup>1)</sup>	[°C]		–20 ... +80	0 ... +120		+5 ... +80
Corrosion resistance class CRC <sup>2)</sup>	2	2	2	2	2	3
ATEX	Specified types → <a href="http://www.festo.com">www.festo.com</a>					

1) Note operating range of proximity sensors.

2) Corrosion resistance class 2 as per Festo standard 940 070

Components subject to moderate corrosion stress. Externally visible parts with primarily decorative surface requirements which are in direct contact with a normal industrial environment or media such as coolants or lubricating agents.

Corrosion resistance class 3 as per Festo standard 940 070

Components requiring higher corrosion resistance. External visible parts in direct contact with industrial atmospheres or media such as solvents and cleaning agents, with a predominantly functional requirement for the surface.

# Standard cylinders DSNU, ISO 6432

Technical data

Speed [mm/s]				
Piston Ø		16	20	25
Speed with stick-slip-free operation, horizontal, without load, at 6 bar	S10	10 ... 100		
Minimum speed, advancing	S11	2.7	5.3	<1 <sup>1)</sup>
Minimum speed, retracting	S11	3.2	4.7	<1 <sup>1)</sup>

1) Measurements of less than 1 mm/s were not conducted

Force [N] and impact energy [J]							
Piston Ø		8	10	12	16	20	25
Theoretical force at 6 bar, advancing		30	47	68	121	189	295
Theoretical force at 6 bar, retracting		23	40	51	104	158	247
Max. impact energy at the end positions for flexible cushioning elements <sup>1)</sup>		0.03	0.05	0.07	0.15	0.20	0.30

1) The values are reduced by approx. 50% at an ambient temperature of 80 °C

## Average piston speed v as a function of applied load m in combination with PPS cushionings

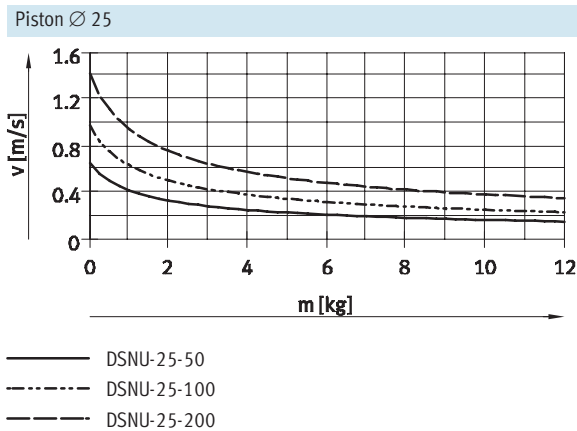
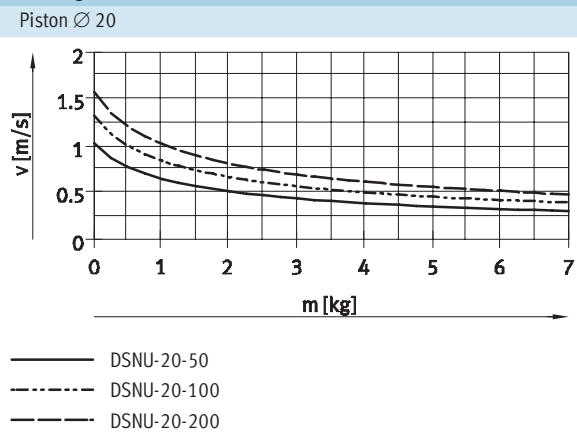
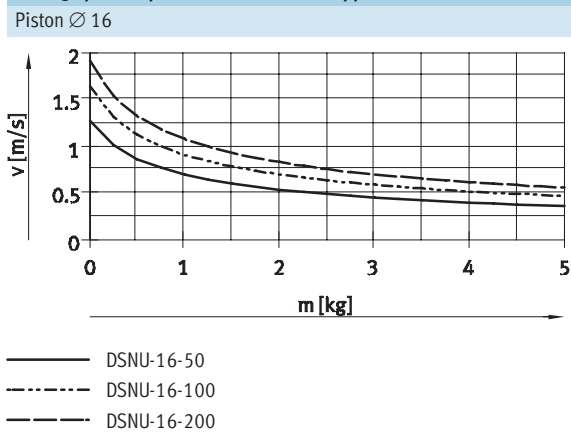

Note  
Average piston speed = stroke/movement time

Note

Design software for flexible cushioning elements → ProDrive

Additional graphs for PPS cushioning → [www.festo.com](http://www.festo.com)

Design software for PPV cushioning → ProDrive

# Standard cylinders DSNU, ISO 6432

Technical data

FESTO

Weight [g]						
Piston $\varnothing$	8	10	12	16	20	25
Product weight with 0 mm stroke	34.6	37.3	75	89.9	186.8	238
Additional weight per 10 mm stroke	2.4	2.7	4	4.6	7.2	11

## Max. lateral force $F_q$ as a function of stroke length $l$

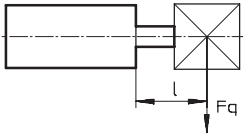

### Basic version

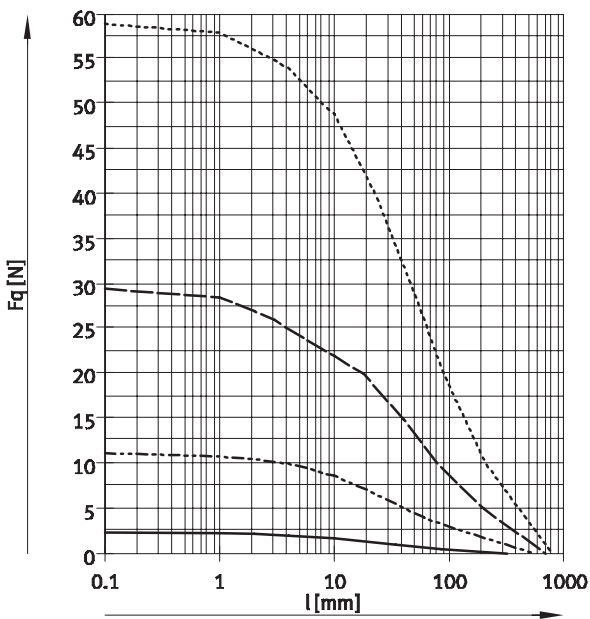

### S2 – Through piston rod

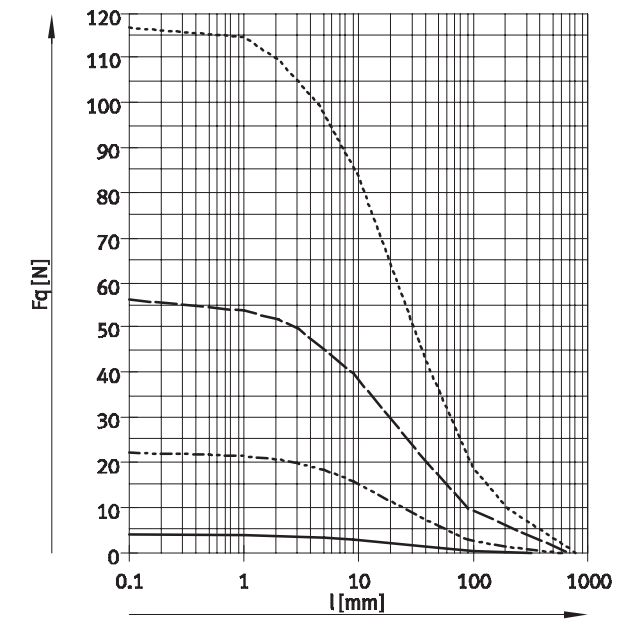

- $\varnothing$  8/10
- - -  $\varnothing$  12/16
- · -  $\varnothing$  20
- · ·  $\varnothing$  25

## Materials

### Sectional view

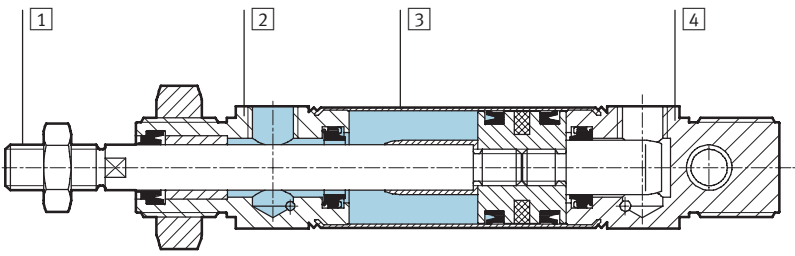

Standard cylinder	Basic version	R3	CT	S6	S10	S11
1 Piston rod	High-alloy stainless steel					
2 Bearing cap	Wrought aluminium alloy					
3 Cylinder barrel	High-alloy stainless steel					
4 End cap	Wrought aluminium alloy					
- Seals	Polyurethane, nitrile rubber			Fluoro elastomer		

# Standard cylinders DSNU, ISO 6432

Technical data

FESTO

## Dimensions

Download CAD data → [www.festo.com](http://www.festo.com)

Basic version

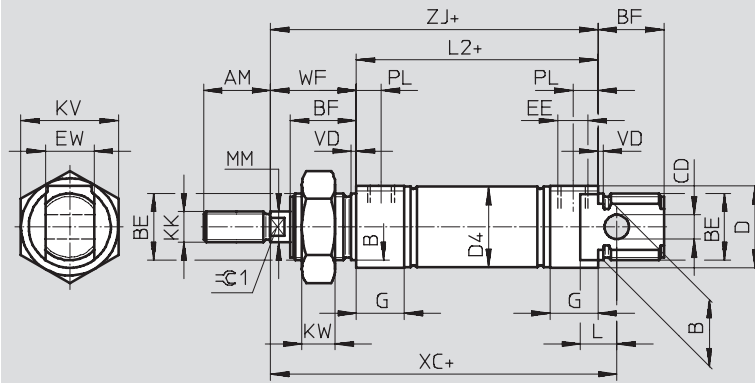

-  - Note  
Piston rod nut is not included in scope of delivery for  $\varnothing 8 \dots 20$ .

+ = plus stroke length

$\varnothing$	AM	B	BE	BF	CD	D	D4	EE	EW	G	KK	KV
[mm]		$\varnothing$ h9			$\varnothing$ E10	$\varnothing$	$\varnothing$					
8	12	12	M12x1.25	12	4	15	9.3	M5	8	10	M4	19
10							11.3					
12	16	16	M16x1.5	17	6	20	13.3					
16							17.3					
20	20	22	M22x1.5	20	8	27	21.3	G $\frac{1}{8}$	16	16	M8	32
25	22			22			26.5					

$\varnothing$	KW	L	L2	MM	PL	TO	VD	WF	XC	ZJ	$\approx C1$
[mm]				$\varnothing$					$\pm 1$		
8	6	6	46	4	6	18	2	16	64	62	-
10			50								
12	8	9	56	6	23	22		75	72	5	
16			82					78			
20	11	12	68	8	8.2	31	24	95	92	7	
25			69.5					10	28	104	97.5

-  - Note: This product conforms with the ISO 1179-1 standard and the ISO 228-1 standard.

# Standard cylinders DSNU, ISO 6432

Technical data

FESTO

## Dimensions

Download CAD data → [www.festo.com](http://www.festo.com)

### MQ – Lateral air connection

### MA – Axial air connection

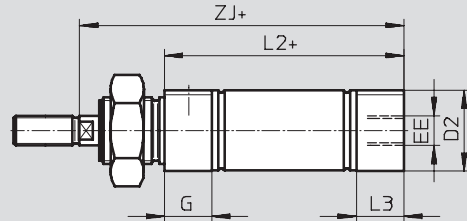
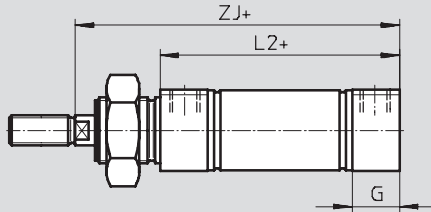

### MH – With direct mounting

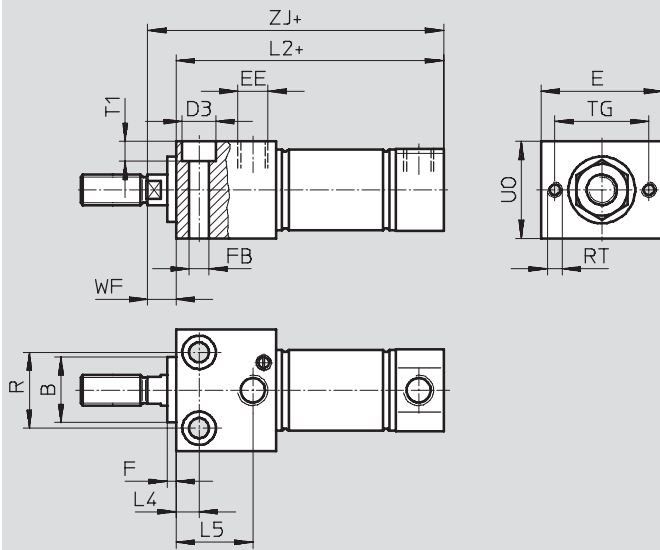

+ = plus stroke length

Ø [mm]	B Ø h9	D2 Ø	D3 Ø	E	EE	F	FB Ø	G	L2		
									-MQ	-MA	-MH
8	12	10.5	6	24	M5	3	3.4	10	46	43.6	53.5
10		12.5								43.1	53.8
12	16	14.5	8	30			4.5		50	47.7	62
16		17.5							56	53.7	67.5
20	22	21.7	10	40	G $\frac{1}{8}$	5.5	16	68	66.5	81.5	
25		26.7	11			6.6		69.5	68.5	86.2	

Ø [mm]	L3	L4	L5	R	RT	TG	T1	UO	WF	ZJ		
										-MQ	-MA	-MH
8	7.6	5	14	12	M3	18	3.4	16	8	62	59.6	61.5
10	7.1										59.1	61.8
12	7.7	6	18.1	16	M4	23	4.5	22	10	72	69.7	72
16										78	75.7	77.8
20	14.5	7.5	22.4	22	M5	31	5.5	28		92	90.5	91.5
25	14		25.2	25			6.6			32	11	97.5

– † – Note: This product conforms with the ISO 1179-1 standard and the ISO 228-1 standard.



# Standard cylinders DSNU, ISO 6432

Technical data

FESTO

## Dimensions

Download CAD data → [www.festo.com](http://www.festo.com)

### S2 – Through piston rod

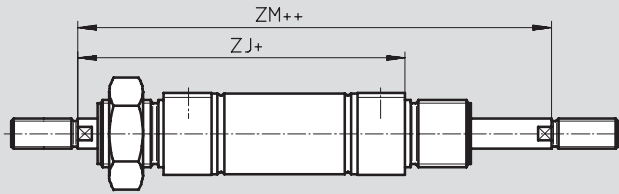

- Note

The thread types at both piston rod ends are identical. In combination with variant Q, the left-hand piston rod end is square, the right-hand piston rod end round.

+ = plus stroke length

++ = plus 2x stroke length

### K2 – Extended male piston rod thread

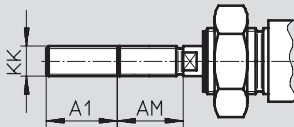

### K6 – Shortened male piston rod thread

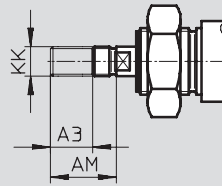

### K3 – Female piston rod thread

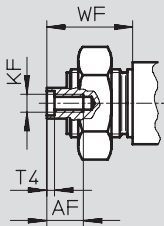

### K5 – Special thread on piston rod

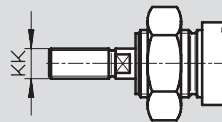

### K8 – Extended piston rod

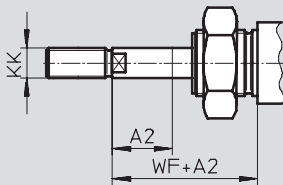

- Note

If variant K8 is required in combination with S2, the piston rod will only be extended on one side.

∅ [mm]	A1 max.	A2 max.	A3 max.	AM	AF	KF	KK		T4	WF	ZJ			ZM
							Basic thread	Special thread <sup>1)</sup>			-MQ	-MA	-MH	
8	15	50	4	12	-	-	M4	-	-	16	62	59.6	61.5	78.4
10					-	-		-				59.1	61.8	
12	20	100		16	-	-	M6	-	-	22	72	69.7	72	94
16					-	-		-				78	75.7	77.8
20	25	110	8	20	12	M4	M8	-	2	24	92	90.5	91.5	116
25	35	150		22		M6	M10x1.25	M10	2.6	28	97.5	96.5	97.2	125.5

1) The special threads are only available as male threads. The scope of delivery does not include a hex nut for the piston rod thread.

# Standard cylinders DSNU, ISO 6432

FESTO



Technical data

Ordering data						
Type	Piston Ø [mm]	Stroke [mm]	P – Flexible cushioning rings/ pads at both ends		PPV – Pneumatic cushioning, adjustable at both ends	
			A – With position sensing		A – With position sensing	
			Part No.	Type	Part No.	Type
<b>Basic version</b>						
	8	10	19 177	DSNU-8-10-P-A	–	
		25	19 178	DSNU-8-25-P-A		
		40	19 179	DSNU-8-40-P-A		
		50	19 180	DSNU-8-50-P-A		
		80	19 181	DSNU-8-80-P-A		
		100	19 182	DSNU-8-100-P-A		
	10	10	19 183	DSNU-10-10-P-A	–	
		25	19 184	DSNU-10-25-P-A		
		40	19 185	DSNU-10-40-P-A		
		50	19 186	DSNU-10-50-P-A		
		80	19 187	DSNU-10-80-P-A		
		100	19 188	DSNU-10-100-P-A		
	12	10	19 189	DSNU-12-10-P-A	–	
		25	19 190	DSNU-12-25-P-A		
		40	19 191	DSNU-12-40-P-A		
		50	19 192	DSNU-12-50-P-A		
		80	19 193	DSNU-12-80-P-A		
		100	19 194	DSNU-12-100-P-A		
		125	19 195	DSNU-12-125-P-A		
		160	19 196	DSNU-12-160-P-A		
		200	19 197	DSNU-12-200-P-A		
	16	10	19 198	DSNU-16-10-P-A	–	
		25	19 199	DSNU-16-25-P-A	33 973	DSNU-16-25-PPV-A
		40	19 200	DSNU-16-40-P-A	19 229	DSNU-16-40-PPV-A
		50	19 201	DSNU-16-50-P-A	19 230	DSNU-16-50-PPV-A
		80	19 202	DSNU-16-80-P-A	19 231	DSNU-16-80-PPV-A
		100	19 203	DSNU-16-100-P-A	19 232	DSNU-16-100-PPV-A
		125	19 204	DSNU-16-125-P-A	19 233	DSNU-16-125-PPV-A
		160	19 205	DSNU-16-160-P-A	19 234	DSNU-16-160-PPV-A
		200	19 206	DSNU-16-200-P-A	19 235	DSNU-16-200-PPV-A
20		10	19 207	DSNU-20-10-P-A	–	
		25	19 208	DSNU-20-25-P-A	33 974	DSNU-20-25-PPV-A
	40	19 209	DSNU-20-40-P-A	19 236	DSNU-20-40-PPV-A	
	50	19 210	DSNU-20-50-P-A	19 237	DSNU-20-50-PPV-A	
	80	19 211	DSNU-20-80-P-A	19 238	DSNU-20-80-PPV-A	
	100	19 212	DSNU-20-100-P-A	19 239	DSNU-20-100-PPV-A	
	125	19 213	DSNU-20-125-P-A	19 240	DSNU-20-125-PPV-A	
	160	19 214	DSNU-20-160-P-A	19 241	DSNU-20-160-PPV-A	
	200	19 215	DSNU-20-200-P-A	19 242	DSNU-20-200-PPV-A	
	250	19 216	DSNU-20-250-P-A	19 243	DSNU-20-250-PPV-A	
	300	19 217	DSNU-20-300-P-A	19 244	DSNU-20-300-PPV-A	
	320	34 718	DSNU-20-320-P-A	34 720	DSNU-20-320-PPV-A	

# Standard cylinders DSNU, ISO 6432

Technical data

Ordering data					
Type	Piston Ø [mm]	Stroke [mm]	P – Flexible cushioning rings/ pads at both ends		PPV – Pneumatic cushioning, adjustable at both ends
			A – With position sensing		
			Part No.	Type	Part No. Type
<b>Basic version</b>					
	25	10	19 218	DSNU-25-10-P-A	–
		25	19 219	DSNU-25-25-P-A	33 975 DSNU-25-25-PPV-A
		40	19 220	DSNU-25-40-P-A	19 245 DSNU-25-40-PPV-A
		50	19 221	DSNU-25-50-P-A	19 246 DSNU-25-50-PPV-A
		80	19 222	DSNU-25-80-P-A	19 247 DSNU-25-80-PPV-A
		100	19 223	DSNU-25-100-P-A	19 248 DSNU-25-100-PPV-A
		125	19 224	DSNU-25-125-P-A	19 249 DSNU-25-125-PPV-A
		160	19 225	DSNU-25-160-P-A	19 250 DSNU-25-160-PPV-A
		200	19 226	DSNU-25-200-P-A	19 251 DSNU-25-200-PPV-A
		250	19 227	DSNU-25-250-P-A	19 252 DSNU-25-250-PPV-A
		300	19 228	DSNU-25-300-P-A	19 253 DSNU-25-300-PPV-A
		320	34 719	DSNU-25-320-P-A	34 721 DSNU-25-320-PPV-A
		400	35 191	DSNU-25-400-P-A	35 193 DSNU-25-400-PPV-A
		500	35 192	DSNU-25-500-P-A	35 194 DSNU-25-500-PPV-A

Ordering data					
Type	Piston Ø [mm]	Stroke [mm]	P – Flexible cushioning rings/ pads at both ends		PPV – Pneumatic cushioning, adjustable at both ends
			A – With position sensing		
			Part No.	Type	Part No. Type
<b>Variable stroke lengths</b>					
	8	10 ... 100	14 326	DSNU-8-...-P-A	–
		10 ... 100	14 325	DSNU-10-...-P-A	
		10 ... 200	14 324	DSNU-12-...-P-A	
		10 ... 200	14 323	DSNU-16-...-P-A	14 320 DSNU-16-...-PPV-A
		10 ... 320	14 328	DSNU-20-...-P-A	14 321 DSNU-20-...-PPV-A
		10 ... 500	14 327	DSNU-25-...-P-A	14 322 DSNU-25-...-PPV-A
<b>Variable stroke lengths, free of copper, PTFE and silicone</b>					
 CT-free	8	10 ... 100	170 121	DSNU-8-...-P-A-CT	–
		10 ... 100	170 122	DSNU-10-...-P-A-CT	
		10 ... 200	170 123	DSNU-12-...-P-A-CT	
		10 ... 200	170 124	DSNU-16-...-P-A-CT	170 127 DSNU-16-...-PPV-A-CT
		10 ... 320	170 125	DSNU-20-...-P-A-CT	170 128 DSNU-20-...-PPV-A-CT
		10 ... 500	170 126	DSNU-25-...-P-A-CT	170 129 DSNU-25-...-PPV-A-CT

 Note  
Additional variants can be configured and ordered via the DSNU product modules → 32.

## Standard cylinders DSNU, ISO 6432

Technical data

**FESTO**

Ordering data						
Type	Piston Ø [mm]	Stroke [mm]	PPS – Pneumatic cushioning, self-adjustable at both ends Without position sensing		PPS – Pneumatic cushioning, self-adjustable at both ends A – With position sensing	
			Part No.	Type	Part No.	Type
Basic version						
	16	25	–		559 263	DSNU-16-25-PPS-A
		40	559 234	DSNU-16-40-PPS	559 264	DSNU-16-40-PPS-A
		50	559 235	DSNU-16-50-PPS	559 265	DSNU-16-50-PPS-A
		80	559 236	DSNU-16-80-PPS	559 266	DSNU-16-80-PPS-A
		100	559 237	DSNU-16-100-PPS	559 267	DSNU-16-100-PPS-A
		125	559 238	DSNU-16-125-PPS	559 268	DSNU-16-125-PPS-A
		160	559 239	DSNU-16-160-PPS	559 269	DSNU-16-160-PPS-A
		200	559 240	DSNU-16-200-PPS	559 270	DSNU-16-200-PPS-A
	20	25	–		559 271	DSNU-20-25-PPS-A
		40	559 241	DSNU-20-40-PPS	559 272	DSNU-20-40-PPS-A
		50	559 242	DSNU-20-50-PPS	559 273	DSNU-20-50-PPS-A
		80	559 243	DSNU-20-80-PPS	559 274	DSNU-20-80-PPS-A
		100	559 244	DSNU-20-100-PPS	559 275	DSNU-20-100-PPS-A
		125	559 245	DSNU-20-125-PPS	559 276	DSNU-20-125-PPS-A
		160	559 246	DSNU-20-160-PPS	559 277	DSNU-20-160-PPS-A
		200	559 247	DSNU-20-200-PPS	559 278	DSNU-20-200-PPS-A
		250	559 248	DSNU-20-250-PPS	559 279	DSNU-20-250-PPS-A
		300	559 249	DSNU-20-300-PPS	559 280	DSNU-20-300-PPS-A
		320	559 250	DSNU-20-320-PPS	559 281	DSNU-20-320-PPS-A
		25	25	–		559 282
	40		559 251	DSNU-25-40-PPS	559 283	DSNU-25-40-PPS-A
	50		559 252	DSNU-25-50-PPS	559 284	DSNU-25-50-PPS-A
	80		559 253	DSNU-25-80-PPS	559 285	DSNU-25-80-PPS-A
	100		559 254	DSNU-25-100-PPS	559 286	DSNU-25-100-PPS-A
	125		559 255	DSNU-25-125-PPS	559 287	DSNU-25-125-PPS-A
	160		559 256	DSNU-25-160-PPS	559 288	DSNU-25-160-PPS-A
	200		559 257	DSNU-25-200-PPS	559 289	DSNU-25-200-PPS-A
	250		559 258	DSNU-25-250-PPS	559 290	DSNU-25-250-PPS-A
300	559 269		DSNU-25-300-PPS	559 291	DSNU-25-300-PPS-A	
320	559 260		DSNU-25-320-PPS	559 292	DSNU-25-320-PPS-A	
400	559 261		DSNU-25-400-PPS	559 293	DSNU-25-400-PPS-A	
500	559 262		DSNU-25-500-PPS	559 294	DSNU-25-500-PPS-A	

 **Note**

Variable stroke lengths and additional variants can be configured and ordered via the DSNU product modules → 32.



# Standard cylinders DSNUP, ISO 6432

**FESTO**

Technical data

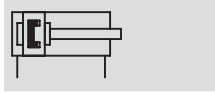
Function



-  - Diameter  
16 ... 25 mm
-  - Stroke length  
25 ... 100 mm



General technical data			
Piston $\varnothing$	16	20	25
Pneumatic connection	M5	G $\frac{1}{8}$	G $\frac{1}{8}$
Constructional design	Piston		
	Piston rod		
	Cylinder barrel		
Mode of operation	Double-acting		
Cushioning	Flexible cushioning rings/pads at both ends		
Position sensing	Via proximity sensor		
Type of mounting	Via accessories		
Mounting position	Any		

Operating and environmental conditions	
Operating medium	Filtered compressed air, lubricated or unlubricated
Operating pressure <sup>1)</sup> [bar]	1 ... 8
Ambient temperature [°C]	-10 ... +60
Corrosion resistance class CRC <sup>2)</sup>	2

1) Note operating range of proximity sensors

2) Corrosion resistance class 2 as per Festo standard 940 070

Components subject to moderate corrosion stress. Externally visible parts with primarily decorative surface requirements which are in direct contact with a normal industrial environment or media such as coolants or lubricating agents.

Force [N] and impact energy [J]			
Piston $\varnothing$	16	20	25
Theoretical force at 6 bar, advancing	121	189	295
Theoretical force at 6 bar, retracting	104	158	247
Impact energy at end positions	0.15	0.20	0.30

Weight [g]			
Piston $\varnothing$	16	20	25
Product weight with 0 mm stroke	47	83	111
Additional weight per 10 mm stroke	4	6	8
Moving load at 0 mm stroke	23	44	71
Additional load per 10 mm stroke	2	4	6

# Standard cylinders DSNUP, ISO 6432

Technical data

Speed without applied load [m/s]			
Piston $\varnothing$	16	20	25
Advancing			
Minimum	0.015	0.02	0.015
Maximum	2.3	2.3	2.3
Retracting			
Minimum	0.015	0.02	0.015
Maximum	1.9	1.7	2.0

## Materials

Sectional view

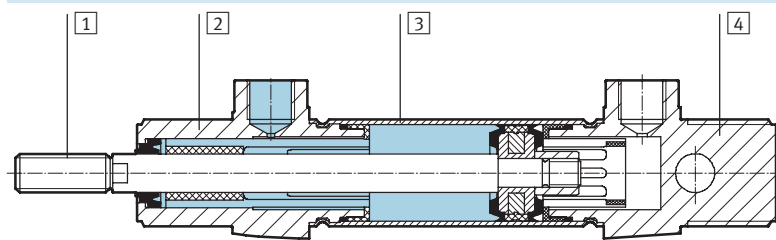

Standard cylinder		
1	Piston rod	High-alloy stainless steel
2	Bearing cap	Polyamide
3	Cylinder barrel	Wrought aluminium alloy
4	End cap	Polyamide
-	Seals	Polyurethane, nitrile rubber
Note on materials		RoHS-compliant

## Permissible lateral force $F_q$ as a function of stroke length $l$

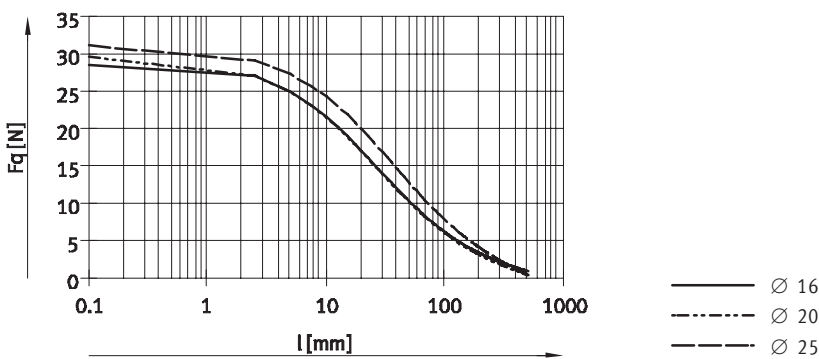

## Permissible piston rod displacement $f$ as a function of stroke length $l$

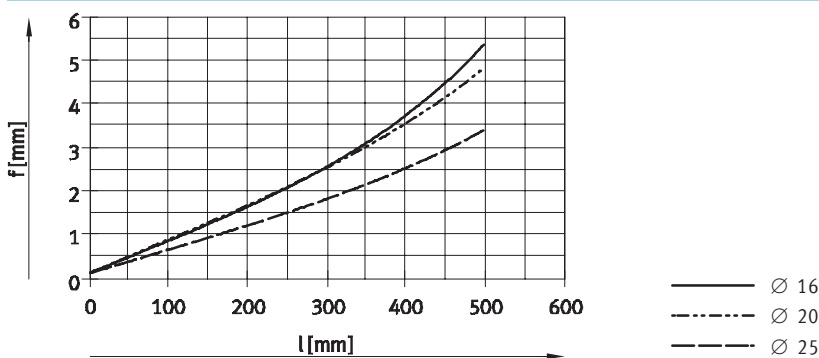

# Standard cylinders DSNUP, ISO 6432

Technical data

**FESTO**

**Dimensions**

Download CAD data → [www.festo.com](http://www.festo.com)

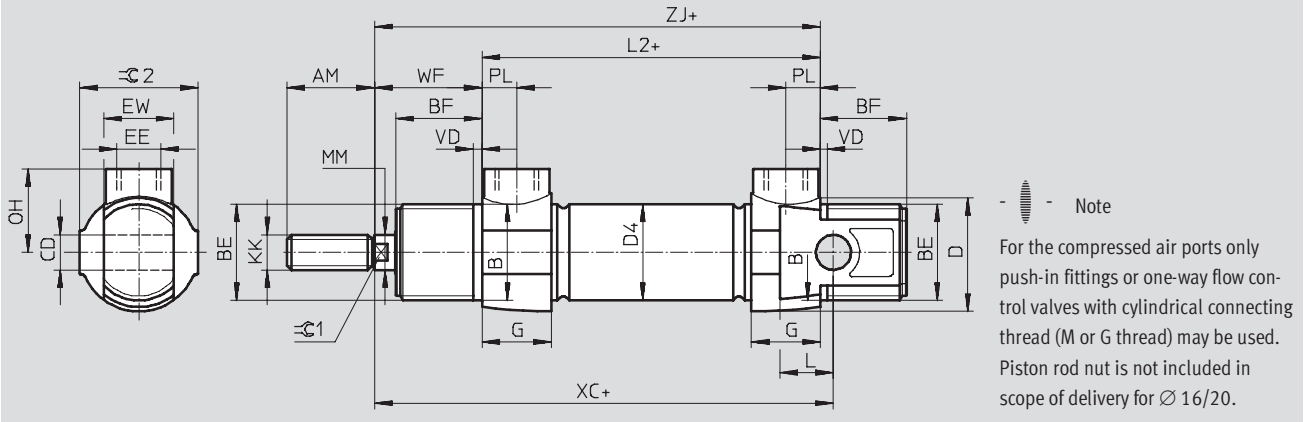

Ø	AM	B	BE	BF	CD	D	D4	EE
[mm]		Ø h9			Ø H9	Ø	Ø	
16	16	16	M16x1.5	17	6	20	18	M5
20	20	22	M22x1.5	20	8	27	22	G <sup>1</sup> / <sub>8</sub>
25	22	22	M22x1.5	22	8	27	27	G <sup>1</sup> / <sub>8</sub>

Ø	EW	G	KK	L	L2	MM	OH	PL	VD
[mm]						Ø			
16	12	10	M6	8	56	6	14	4.9	2
20	16	16	M8	12	68	8	19	7.9	2
25	16	16	M10x1.25	12	70	10	19	7.9	2

Ø	WF	XC	ZJ	≅C 1	≅C 2	Max. tightening torque of thread [Nm]	
						BE <sup>1)</sup>	EE
[mm]		±1					
16	22	82	78	5	19	12/8	1.3
20	24	95	92	7	27	22/15	6
25	28	104	98	9	27	22/15	6

1) Bearing cap/end cap

Note  
Variable strokes on request.

Ordering data			
Piston Ø [mm]	Stroke [mm]	Part No.	Type
16	25	551 668	DSNUP-16-25-P-A
	50	551 669	DSNUP-16-50-P-A
	100	551 670	DSNUP-16-100-P-A
20	25	551 671	DSNUP-20-25-P-A
	50	551 672	DSNUP-20-50-P-A
	100	551 673	DSNUP-20-100-P-A
25	25	551 674	DSNUP-25-25-P-A
	50	551 675	DSNUP-25-50-P-A
	100	551 676	DSNUP-25-100-P-A

# Standard cylinders DSNU-Q, protected against rotation

FESTO

Technical data

Function

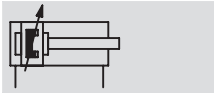
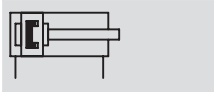

⌀ - Diameter  
12 ... 25 mm

— | — Stroke length  
1 ... 250 mm

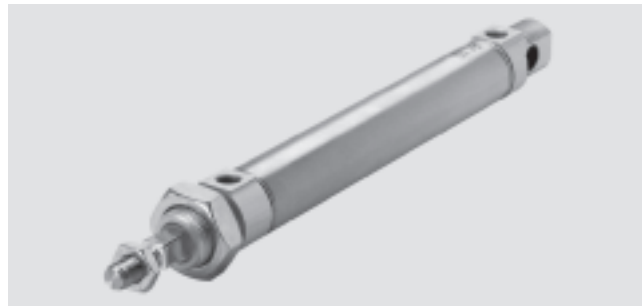

General technical data				
Piston ⌀	12	16	20	25
Pneumatic connection	M5	M5	G $\frac{1}{8}$	G $\frac{1}{8}$
Piston rod thread	M6	M6	M8	M10x1.25
Operating medium	Compressed air, filtered, lubricated or unlubricated			
Constructional design	Piston			
	Protected against rotation with square piston rod			
Max. torque at the piston rod [Nm]	0.10	0.10	0.20	0.45
Cushioning	Flexible cushioning rings/pads at both ends			
	Adjustable cushioning at both ends			
Cushioning length (PPV) [mm]	–	12	15	17
Position sensing	Via proximity sensor			
Type of mounting	Via accessories			
Mounting position	Any			

⚡ - Note: This product conforms with the ISO 1179-1 standard and the ISO 228-1 standard.

Operating conditions				
Piston ⌀	12	16	20	25
Operating medium	Filtered compressed air, lubricated or unlubricated			
Operating pressure [bar]	1.5 ... 10 <sup>1)</sup>	1 ... 10		

1) With DSNU-12- ... -Q- PPV (pneumatic cushioning adjustable at both ends); 2 ... 10 bar

Ambient conditions		
Standard cylinder	Basic version	R3
Ambient temperature <sup>1)</sup> [°C]	–20 ... +80	
Corrosion resistance class CRC <sup>2)</sup>	2	3

1) Note operating range of proximity sensors.

2) Corrosion resistance class 2 as per Festo standard 940 070

Components subject to moderate corrosion stress. Externally visible parts with primarily decorative surface requirements which are in direct contact with a normal industrial environment or media such as coolants or lubricating agents.

Corrosion resistance class 3 as per Festo standard 940 070

Components requiring higher corrosion resistance. External visible parts in direct contact with industrial atmospheres or media such as solvents and cleaning agents, with a predominantly functional requirement for the surface.



# Standard cylinders DSNU-Q, protected against rotation

Technical data

Forces [N] and impact energy [J]				
Piston Ø	12	16	20	25
Theoretical force at 6 bar, advancing	68	121	189	295
Theoretical force at 6 bar, retracting	51	104	158	247
Max. impact energy at the end positions for flexible cushioning elements <sup>1)</sup>	0.07	0.15	0.20	0.30

1) The values are reduced by approx. 50% at an ambient temperature of 80 °C

Weight [g]				
Piston Ø	12	16	20	25
Product weight with 0 mm stroke	80	110	215	275
Additional weight per 10 mm stroke	4.1	4.7	7.1	10.9

## Materials

Sectional view

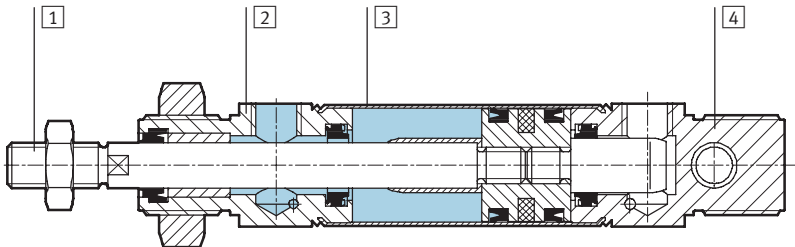

Standard cylinder		
1	Piston rod	High-alloy stainless steel
2	Bearing cap	Wrought aluminium alloy
3	Cylinder barrel	High-alloy stainless steel
4	End cap	Wrought aluminium alloy
-	Seals	Polyurethane, nitrile rubber

# Standard cylinders DSNU-Q, protected against rotation

Technical data

Dimensions Download CAD data → [www.festo.com](http://www.festo.com)

Basic version

The drawing shows a side view and two end views of the cylinder. Dimensions are labeled as follows: AM, B, B1, BE, BF, CD, D, D4, EE, EW, G, KK, KV, KW, L, L2, PL, VD, WF, XC, ZJ. A note indicates that the piston rod nut is not included in the scope of delivery for diameters 12 to 20 mm. A plus sign (+) denotes plus stroke length.

Note  
Piston rod nut is not included in scope of delivery for  $\varnothing 12 \dots 20$ .

+ = plus stroke length

$\varnothing$	AM	B	B1	BE	BF	CD	D	D4	EE	EW
[mm]		$\varnothing$ h9	$\square$			$\varnothing$ E10	$\varnothing$	$\varnothing$		
12	16	16	5.5	M16x1.5	17	6	20	13.3	M5	12
16								17.3		
20	22	22	7	M22x1.5	20	8	27	21.3	G1/8	16
25			9		22			26.5		

$\varnothing$	G	KK	KV	KW	L	L2	PL	VD	WF	XC	ZJ
[mm]										$\pm 1$	
12	10	M6	24	8	9	50	6	2	22	75	72
16						56				82	78
20	16	M8	32	11	12	68	8.2		24	95	92
25		M10x1.25				69.5	28		104	97.5	

- | - Note: This product conforms with the ISO 1179-1 standard and the ISO 228-1 standard.

# Standard cylinders DSNU-KP, with clamping unit

Technical data

Function

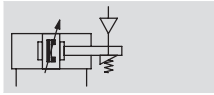
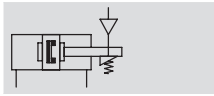

⌀ - Diameter  
8 ... 25 mm

█ - Stroke length  
1 ... 500 mm

⚠ - Note

Additional measures are required for use in safety-related applications; in Europe, for example, the standards listed under the EC Machinery Directive must be observed. Without additional measures in accordance with statutory minimum requirements, the product is not suitable for use in safety-related sections of control systems.



General technical data						
Piston ⌀	8	10	12	16	20	25
Pneumatic connection	M5	M5	M5	M5	G $\frac{1}{8}$	G $\frac{1}{8}$
Piston rod thread	M4	M4	M6	M6	M8	M10x1.25
Constructional design	Piston					
	Piston rod					
	Cylinder barrel					
Cushioning	P	Flexible cushioning rings/pads at both ends				
	PPV	-			Pneumatic cushioning, adjustable at both ends	
	PPS	-			Self-adjusting cushioning at both ends	
Cushioning length	PPV [mm]	-		9	12	15
	PPS [mm]	-		12	15	17
Position sensing	Via proximity sensor					
Type of mounting	Via through-holes					
	Via accessories					
Mounting position	Any					
Holding force of the clamping unit [N]	80	80	180	180	350	350
Max. axial backlash with clamped piston rod without load [mm]	0.2		0.3			0.5
Pneumatic connection of the clamping unit	M5					

⚠ - Note: This product conforms with the ISO 1179-1 standard and the ISO 228-1 standard.

Operating conditions						
Piston ⌀	8	10	12	16	20	25
Operating medium	Filtered compressed air, lubricated or unlubricated					
Operating pressure [bar]	3 ... 10					

Ambient conditions		
Standard cylinder	Basic version	R3
Ambient temperature <sup>1)</sup> [°C]	-10 ... +80	
Corrosion resistance class CRC <sup>2)</sup>	2	
	3	

1) Note operating range of proximity sensors.

2) Corrosion resistance class 2 as per Festo standard 940 070

Components subject to moderate corrosion stress. Externally visible parts with primarily decorative surface requirements which are in direct contact with a normal industrial environment or media such as coolants or lubricating agents.

Corrosion resistance class 3 as per Festo standard 940 070

Components requiring higher corrosion resistance. External visible parts in direct contact with industrial atmospheres or media such as solvents and cleaning agents, with a predominantly functional requirement for the surface.

# Standard cylinders DSNU-KP, with clamping unit

Technical data



Force [N] and impact energy [J]						
Piston Ø	8	10	12	16	20	25
Theoretical force at 6 bar, advancing	30	47	68	121	189	295
Theoretical force at 6 bar, retracting	23	40	51	104	158	247
Max. impact energy at the end positions for flexible cushioning elements <sup>1)</sup>	0.03	0.05	0.07	0.15	0.20	0.30

1) The values are reduced by approx. 50% at an ambient temperature of 80 °C

## Average piston speed v as a function of applied load m in combination with cushioning PPS

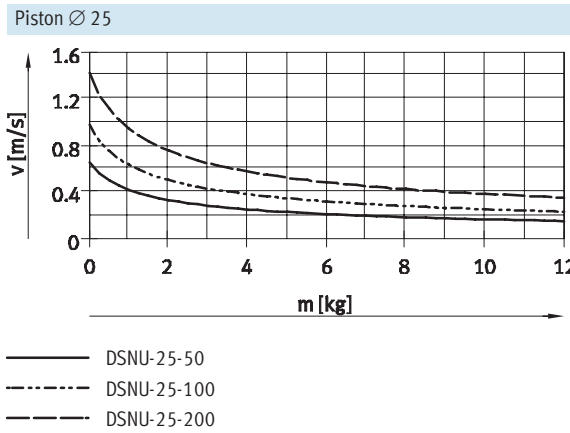
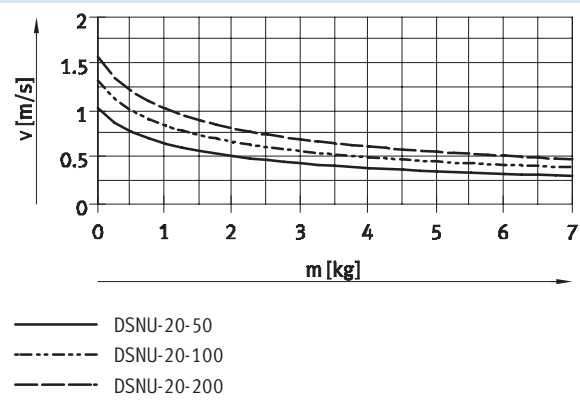
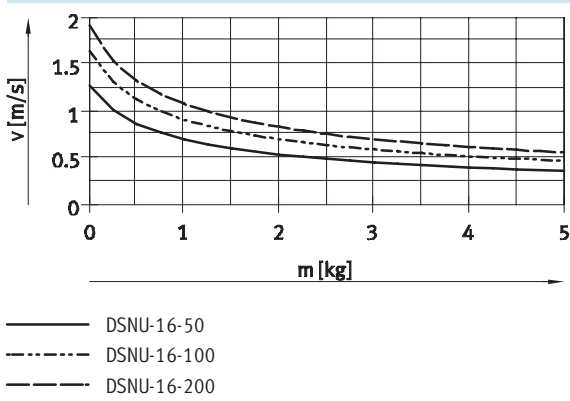

- Note  
Average piston speed = stroke/movement time

- Note

Design software for flexible cushioning elements → ProDrive

Additional graphs for PPS cushioning → [www.festo.com](http://www.festo.com)

Design software for PPV cushioning → ProDrive

Weight [g]						
Piston Ø	8	10	12	16	20	25
Product weight with 0 mm stroke	97.6	100.3	193	207.9	393.8	456
Additional weight per 10 mm stroke	2.4	2.7	4	4.6	7.2	11

# Standard cylinders DSNU-KP, with clamping unit

Technical data

## Max. lateral force $F_q$ as a function of the projection $l$

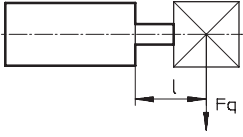

### Basic version

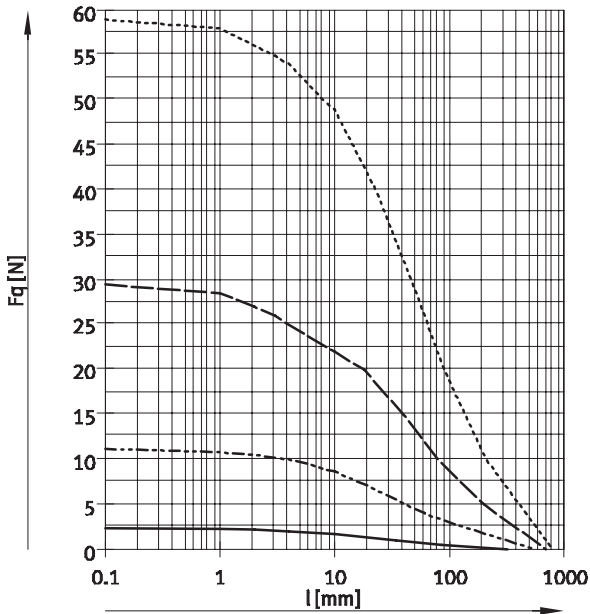

### S2 – Through piston rod

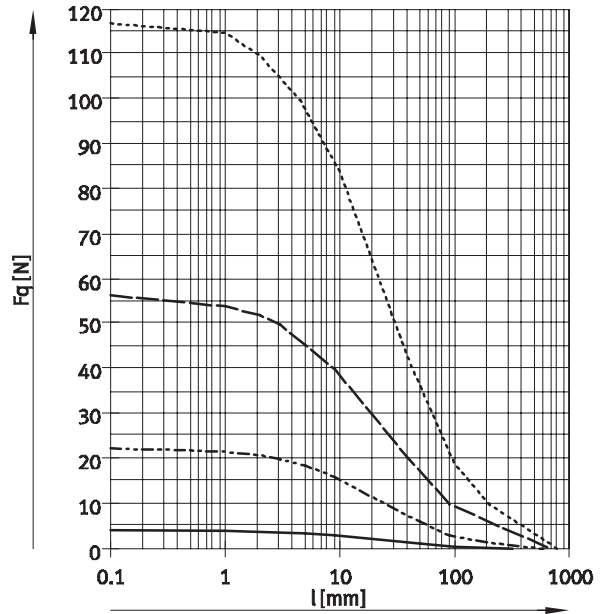

- Ø 8/10
- - - Ø 12/16
- · - Ø 20
- · · Ø 25

## Materials

### Sectional view

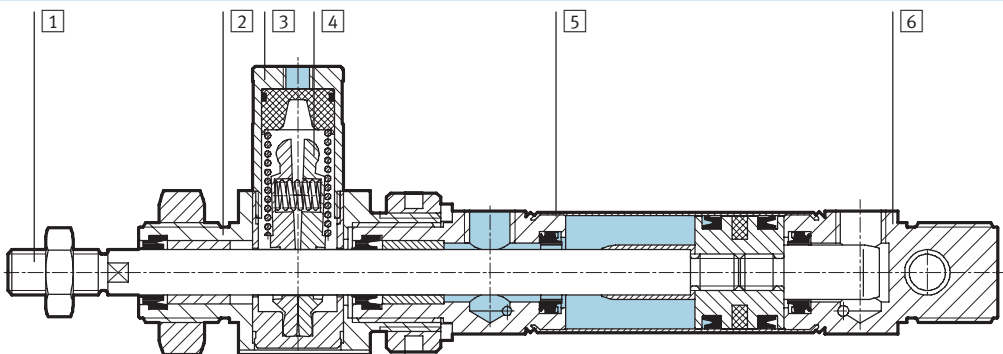

### Standard cylinder

1	Piston rod	High-alloy stainless steel
2	Bearing cap	Wrought aluminium alloy
3	Housing, clamping unit	Wrought aluminium alloy
4	Clamping jaws	Brass
5	Cylinder barrel	High-alloy stainless steel
6	End cap	Wrought aluminium alloy
-	Piston, clamping unit	Polyacetate
-	Spring	Spring steel
-	Seals	Polyurethane, nitrile rubber

# Standard cylinders DSNU-KP, with clamping unit

Technical data

FESTO

## Dimensions

Download CAD data → [www.festo.com](http://www.festo.com)

Basic version

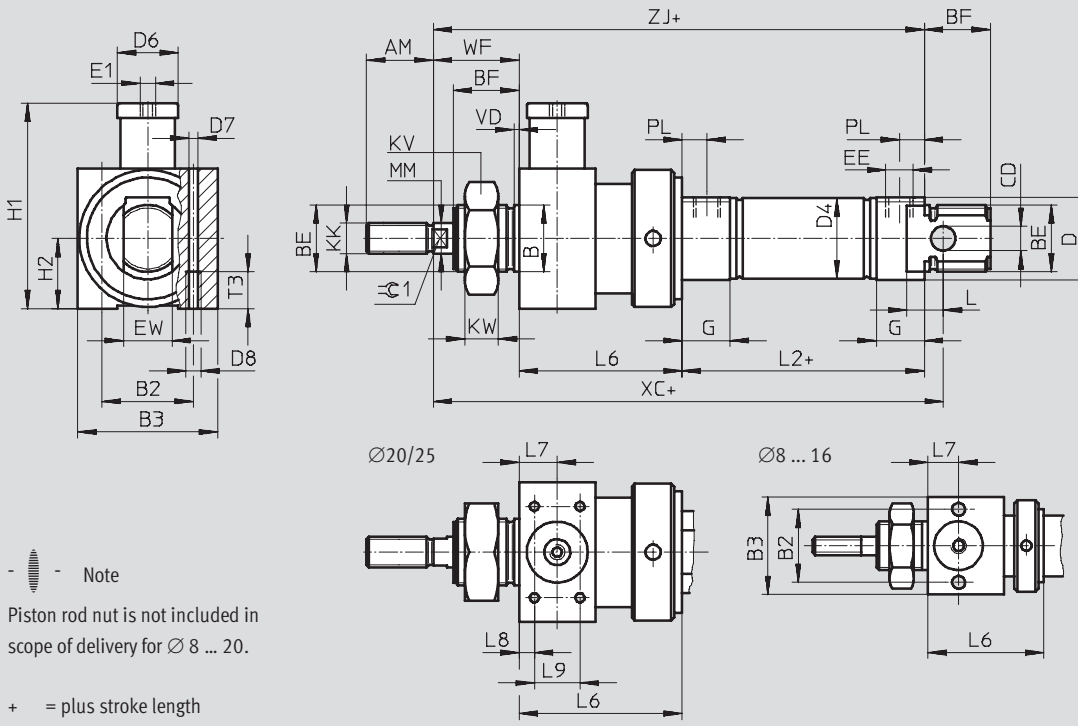

## S2 – Through piston rod

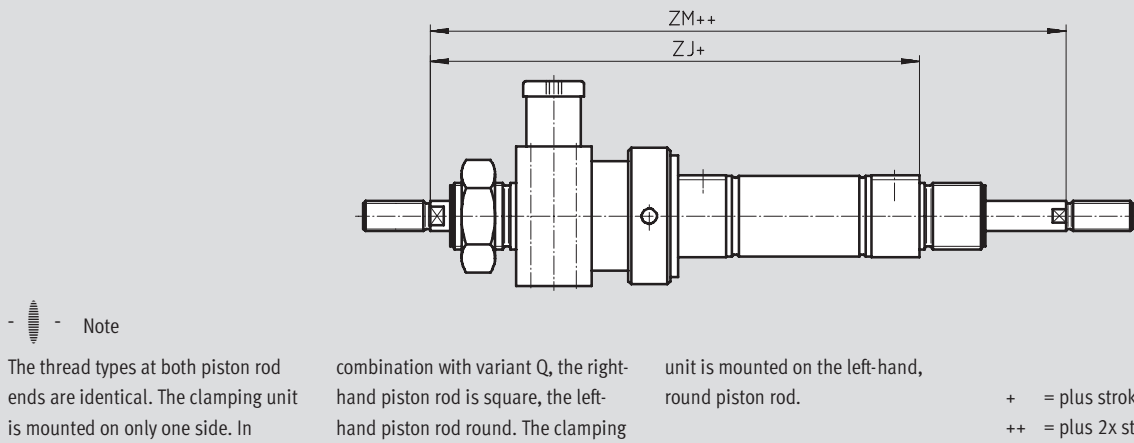

# Standard cylinders DSNU-KP, with clamping unit

Technical data

∅ [mm]	AM	B ∅ h9	B2	B3	BE	BF	CD ∅ E10	D ∅	D4 ∅	D6 ∅	D7 ∅	D8
8	12	12	19.5	27	M12x1.25	12	4	15	9.3	12	4.2	M5
10									11.3			
12	16	16	24	32	M16x1.5	17	6	20	13.3			
16									17.3			
20	20	22	27	36	M22x1.5	20	8	27	21.3			
25	22					22			26.5			

∅ [mm]	E1	EE	EW	G	H1	H2	KK	KV	KW	MM ∅	L	L2
8	M5	M5	8	10	34.5	13.5	M4	19	6	4	6	46
10			12		41	16	M6	24	8	6	9	50
12			16	16	16	62.5	18	M8	32	11	8	12
16		G1/8	16	16	62.5	18	M10x1.25	10			10	12
20			25									

∅ [mm]	L6	L7	L8	L9	T3	PL	VD	WF	XC ±1	ZJ	ZM	≈C1		
8	29 ±0.65	8	-	-	11	6	2	16	93	91	107	-		
10			-	-								-	-	
12	38 ±0.75	10	-	-				8.2	24	22	113	110	132	5
16			-	-							120	116	138	
20	47 ±0.75	13	4.5	20	28	28	142	139	163	173.5	7			
25	48 ±0.75		152	145.5			173.5	9						

- || - Note: This product conforms with the ISO 1179-1 standard and the ISO 228-1 standard.

## Standard cylinders DSNU, ISO 6432

Ordering data – Modular products

M Mandatory data					O Options →		
Module No.	Function	Piston Ø	Stroke	Cushioning	Position sensing	Cylinder end cap	Type of piston rod
193 986	DSNU	8	1 ... 500	P PPV PPS	A	MQ MA MH	S2
193 987		10					
193 988		12					
193 989		16					
193 990		20					
193 991		25					
<b>Order example</b>							
<b>193 991</b>	<b>DSNU</b>	<b>- 25</b>	<b>- 350</b>	<b>- PPV</b>	<b>- A</b>	<b>- MH</b>	<b>- S2</b>

Ordering table										
Size	8	10	12	16	20	25	Condi- tions	Code	Enter code	
M Module No.	<b>193 986</b>	<b>193 987</b>	<b>193 988</b>	<b>193 989</b>	<b>193 990</b>	<b>193 991</b>				
Function	Standard cylinder, double-acting, based on ISO 6432								<b>DSNU</b>	
Piston Ø [mm]	8	10	12	16	20	25		-...		
Stroke [mm]	1 ... 100		1 ... 200		1 ... 320		1 ... 500			
Cushioning	Flexible cushioning rings/pads at both ends								<b>-P</b>	
	Pneumatic cushioning, adjustable at both ends							<b>1</b>	<b>-PPV</b>	
	Pneumatic cushioning, self-adjusting at both ends							<b>13</b>	<b>-PPS</b>	
O Position sensing	Via proximity sensor							<b>2</b>	<b>-A</b>	
Cylinder end cap	Lateral supply port, end cap							<b>3</b>	<b>-MQ</b>	
	Axial supply port, end cap							<b>3</b>	<b>-MA</b>	
	With mounting flange at front (direct mounting), bearing cap							<b>4</b>	<b>-MH</b>	
↓ Type of piston rod	Through piston rod							<b>5</b>	<b>-S2</b>	

- 1 PPV** Not with MA.  
In combination with S6, S10, S11 not with piston Ø 12 mm
- 2 A** Minimum stroke: 10 mm
- 3 MQ, MA** Not with S2, S10, S11

- 4 MH** Not with combination S6-R3.  
Not with KP, S10, S11
- 5 S2** Not with S10, S11
- 13 PPS** Not with MA, MH, S6, S10, S11  
and not with combination MQ-R3

 **Note**

The bellows kit DADB must not be used in combination with the variant MH.

The running characteristics change slightly when the bellows kit DADB is combined with the variant S10 or S11.

**Transfer order code**

**DSNU** -  -  -  -  -  -



## Standard cylinders DSNU, ISO 6432

Ordering data – Modular products

**FESTO**

→ 0 Options									
Extended male thread	Shortened male thread	Female thread	Special thread	Extended piston rod	Clamping unit	Temperature resistance	Slow speed (constant motion)	Low friction	Corrosion protection
...K2	...K6	K3	"..."K5	...K8	KP	S6	S10	S11	R3
-	- <b>7K6</b> -	-	- <b>"M10"K5</b> -	-	-	-	-	-	- <b>R3</b> -

Ordering table										
Size	8	10	12	16	20	25	Condi- tions	Code	Enter code	
Extended male thread [mm]	Extended male piston rod thread 1 ... 15		1 ... 20		1 ... 25	1 ... 35	6	-...K2		
Shortened male thread [mm]	Shortened male piston rod thread 1 ... 4				1 ... 8	1 ... 10	7	-...K6		
Female thread	Female piston rod thread				(M4)	(M6)	8	-K3		
Special thread	Piston rod with special thread							-..."K5		
Piston rod extended at one end [mm]	Extended piston rod at one end 1 ... 50		1 ... 100		1 ... 110	1 ... 150		...K8		
Clamping unit	Attached						9	-KP		
Temperature resistance	Heat-resistant seals for temperatures up to 120 °C						10	-S6		
Slow speed (constant motion)	Slow speed (constant motion at low piston speeds)						11	-S10		
Low friction	Low friction						12	-S11		
Corrosion protection	High corrosion protection							-R3		

- 6 **K2** Not with K3, K6
- 7 **K6** Not with K3
- 8 **K3** Not with K5
- 9 **KP** Not with S6, S10, S11, R3

- 10 **S6** Not with S10, S11
- 11 **S10** Not with S11, R3
- 12 **S11** Not with R3

Transfer order code

- [ ] - [ ] - [ ] - [ ] - [ ] - [ ] - [ ] - [ ] - [ ] - [ ]

# Standard cylinders DSNU-Q, protected against rotation

Ordering data – Modular products

M Mandatory data					O Options →			
Module No.	Function	Piston Ø	Stroke	Cushioning	Position sensing	Cylinder end cap	Protection against rotation	Type of piston rod
193 988	DSNU	12	1 ... 500	P	A	MQ	Q	S2
193 989		16		PPV		MA		
193 990		20				MH		
193 991		25						
<b>Order example</b>								
<b>193 990</b>	<b>DSNU</b>	<b>20</b>	<b>150</b>	<b>PPV</b>	<b>A</b>	<b>MQ</b>	<b>Q</b>	

Ordering table								
Size	12	16	20	25	Condi- tions	Code	Enter code	
M Module No.	193 988	193 989	193 990	193 991				
Function	Standard cylinder, double-acting, based on ISO 6432					DSNU	DSNU	
Piston Ø [mm]	12	16	20	25		-...		
Stroke [mm]	5 ... 160		5 ... 200		5 ... 250		-...	
Cushioning	Flexible cushioning rings/pads at both ends		-	-	-	-P		
	-		Pneumatic cushioning, adjustable at both ends			-PPV		
O Position sensing	Via proximity sensor					1	-A	
Cylinder end cap	Lateral supply port, end cap					2	-MQ	
	Axial supply port, end cap		-	-	-	2	-MA	
	-		With mounting flange at front (direct mounting), bearing cap			3	-MH	
Protection against rotation	Square piston rod						-Q	
Type of piston rod	Through piston rod						-S2	

- 1 A Minimum stroke: 10 mm
- 2 MQ, MA Not with S2

- 3 MH Not with combination Q-R3

 Note  
The bellows kit DADB must not be used in combination with the variant Q.

Transfer order code

# Standard cylinders DSNU-Q, protected against rotation

Ordering data – Modular products

→ 0 Options						
Extended male thread	Shortened male thread	Female thread	Special thread	Extended piston rod	Clamping unit	Corrosion protection
...K2	...K6	K3	"..."K5	...K8	KP	R3
- 20K2	-	-	-	- 60K8	- KP	-

Ordering table								
Size	12	16	20	25	Condi- tions	Code	Enter code	
Extended male thread [mm]	Extended male piston rod thread 1 ... 20			1 ... 25	1 ... 35	4	-...K2	
Shortened male thread [mm]	Shortened male piston rod thread 1 ... 4			1 ... 8	1 ... 10	5	-...K6	
Female thread	Female piston rod thread -		(M4)	(M6)	6	-K3		
Special thread	Piston rod with special thread -			M10		-"...K5		
Piston rod extended at one end [mm]	Extended piston rod at one end 1 ... 100		1 ... 110	1 ... 150		...K8		
Clamping unit	Attached				7	-KP		
Corrosion protection	-		High corrosion protection			-R3		

- 4 K2 Not with K3, K6
- 5 K6 Not with K3
- 6 K3 Not with K5

- 7 KP Only with S2.  
Not with R3

Transfer order code

- [ ] - [ ] - [ ] - [ ] - [ ] - [ ] - [ ]

# Standard cylinders ESNU, ISO 6432

FESTO

Technical data

## Function



∅ - Diameter  
8 ... 25 mm

l - Stroke length  
1 ... 50 mm

## Variant

CT-free

Additional variants  
→ 39



Basic version



Axial air connection MA

General technical data						
Piston ∅	8	10	12	16	20	25
Pneumatic connection	M5	M5	M5	M5	G1/8	G1/8
Piston rod thread	M4	M4	M6	M6	M8	M10x1.25
Constructional design	Piston					
	Piston rod					
	Cylinder barrel					
Cushioning	Flexible cushioning rings/pads at both ends					
Position sensing	Via proximity sensor					
Type of mounting	Via accessories					
Mounting position	Any					

- | - Note: This product conforms with the ISO 1179-1 standard and the ISO 228-1 standard.

Operating conditions						
Piston ∅	8	10	12	16	20	25
Operating medium	Filtered compressed air, lubricated or unlubricated					
Operating pressure [bar]	1.5 ... 10			1.2 ... 10		

Ambient conditions						
Standard cylinder						
Ambient temperature <sup>1)</sup> [°C]	-20 ... +80					
Corrosion resistance class CRC <sup>2)</sup>	2					

1) Note operating range of proximity sensors.

2) Corrosion resistance class 2 as per Festo standard 940 070

Components subject to moderate corrosion stress. Externally visible parts with primarily decorative surface requirements which are in direct contact with a normal industrial environment or media such as coolants or lubricating agents.

# Standard cylinders ESNU, ISO 6432

Technical data

Force [N] and impact energy [J]						
Piston Ø	8	10	12	16	20	25
Theoretical force at 6 bar, advancing	24	41	61	107	169	270
Spring return force 10 mm stroke	4.9	4.9	6.3	13.2	18.3	22.9
Spring return force 25 mm stroke	4.1	4.1	5.4	11.9	16.5	21.2
Spring return force 50 mm stroke	2.8	4.8	3.9	9.8	13.6	18.5
Max. impact energy at the end positions <sup>1)</sup>	0.03	0.05	0.07	0.15	0.20	0.30

1) The values are reduced by approx. 50% at ambient temperatures of 80 °C

Weight ESNU-... [g]						
Piston Ø	8	10	12	16	20	25
Product weight with 0 mm stroke	35	37.3	75	89.9	186.8	238
Additional weight per 10 mm stroke	2.4	2.7	4	4.6	7.2	11

Weight ESNU-...-MA [g]						
Piston Ø	8	10	12	16	20	25
Product weight with 0 mm stroke	30	33	65	81	167	222
Additional weight per 10 mm stroke	2.4	2.7	4	4.6	7.2	11

## Materials

Sectional view

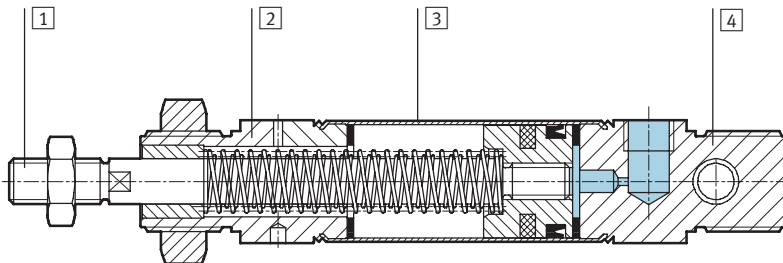

Standard cylinder		
1	Piston rod	High-alloy stainless steel
2	Bearing cap	Wrought aluminium alloy
3	Cylinder barrel	High-alloy stainless steel
4	End cap	Wrought aluminium alloy
-	Seals	Polyurethane, nitrile rubber
-	Spring	Spring steel

# Standard cylinders ESNU, ISO 6432

Technical data

FESTO

## Dimensions

Download CAD data → [www.festo.com](http://www.festo.com)

### Basic version

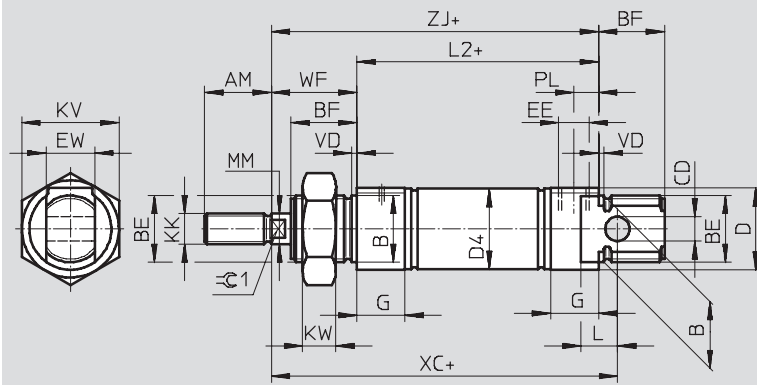

Note  
Piston rod nut is not included in scope of delivery for  $\varnothing$  8 ... 20.  
+ = plus stroke length

### MA – Axial air connection

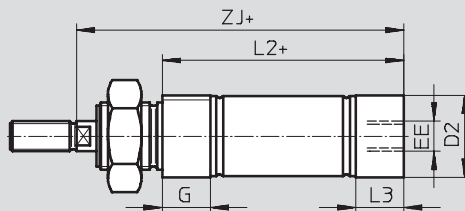

+ = plus stroke length

$\varnothing$ [mm]	AM	B $\varnothing$ h9	BE	BF	CD $\varnothing$ E10	D $\varnothing$	D2 $\varnothing$	D4 $\varnothing$	EE	EW	G	KK	KV
8	12	12	M12x1.25	12	4	15	10.5	9.3	M5	8	10	M4	19
10							12.5	11.3					
12	16	16	M16x1.5	17	6	20	14.5	13.3	M5	12	10	M6	24
16							17.5	17.3					
20	20	22	M22x1.5	20	8	27	21.7	21.3	G $\frac{1}{8}$	16	16	M8	32
25	22		M10x1.25	22			26.7	26.5					

$\varnothing$ [mm]	KW	L	L2		L3	MM $\varnothing$	PL	VD	WF	XC $\pm 1$	ZJ		$\approx \pm 1$
				-MA								-MA	
8	6	6	46	43.6	7.6	4	6	2	16	64	62	59.6	-
10				43.1								7.1	
12	8	9	50	47.7	7.7	6	6	2	22	75	72	69.7	5
16				53.7								82	
20	11	12	68	66.5	14.5	8	8.2	2	24	95	92	90.5	7
25				69.5								68.5	

Note: This product conforms with the ISO 1179-1 standard and the ISO 228-1 standard.

# Standard cylinders ESNU, ISO 6432

Technical data

FESTO

## Dimensions

Download CAD data → [www.festo.com](http://www.festo.com)

K2 – Extended male piston rod thread

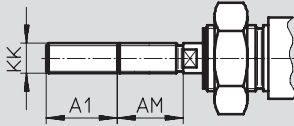

K6 – Shortened male piston rod thread

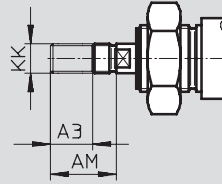

K3 – Female piston rod thread

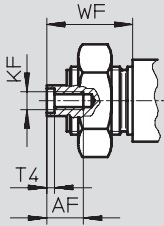

K5 – Special piston rod thread

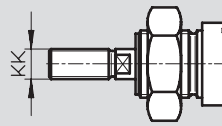

K8 – Extended piston rod

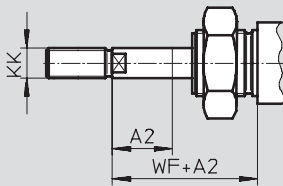

∅ [mm]	A1 max.	A2 max.	A3 max.	AF	AM	KF	KK		T4	WF
							Basic thread	Special thread <sup>1)</sup>		
8	15	50	4	–	12	–	M4	–	–	16
10				–		–				
12				–		–				
16	20		8	–	16	–	M6	–	–	22
20						25		12	20	
25	35			22	–	22	M6	M10x1.25	M10	2.6

1) The special threads are only available as male threads. The scope of delivery does not include a hex nut for the piston rod thread.

# Standard cylinders ESNU, ISO 6432

Technical data



Ordering data			
Type	Stroke [mm]	Part No.	Type
Basic version			
	Ø 8 mm		
	10	19 254	ESNU-8-10-P-A
	25	19 255	ESNU-8-25-P-A
	50	19 256	ESNU-8-50-P-A
	Ø 10 mm		
	10	19 257	ESNU-10-10-P-A
	25	19 258	ESNU-10-25-P-A
	50	19 259	ESNU-10-50-P-A
	Ø 12 mm		
	10	19 260	ESNU-12-10-P-A
	25	19 261	ESNU-12-25-P-A
	50	19 262	ESNU-12-50-P-A
	Ø 16 mm		
	10	19 263	ESNU-16-10-P-A
	25	19 264	ESNU-16-25-P-A
	50	19 265	ESNU-16-50-P-A
	Ø 20 mm		
	10	19 266	ESNU-20-10-P-A
	25	19 267	ESNU-20-25-P-A
	50	19 268	ESNU-20-50-P-A
	Ø 25 mm		
	10	19 269	ESNU-25-10-P-A
	25	19 270	ESNU-25-25-P-A
	50	19 271	ESNU-25-50-P-A



# Standard cylinders ESNU, ISO 6432

Technical data

**FESTO**

Ordering data				
Type	∅ [mm]	Stroke [mm]	Part No.	Type
Variable stroke lengths				
	8	1 ... 50	<b>14 119</b>	<b>ESNU-8-...-P-A</b>
	10	1 ... 50	<b>14 118</b>	<b>ESNU-10-...-P-A</b>
	12	1 ... 50	<b>14 317</b>	<b>ESNU-12-...-P-A</b>
	16	1 ... 50	<b>14 316</b>	<b>ESNU-16-...-P-A</b>
	20	1 ... 50	<b>14 319</b>	<b>ESNU-20-...-P-A</b>
	25	1 ... 50	<b>14 318</b>	<b>ESNU-25-...-P-A</b>
Free of copper, PTFE and silicone				
 CT-free	8	1 ... 50	<b>170 130</b>	<b>ESNU-8-...-P-A-CT</b>
	10	1 ... 50	<b>170 131</b>	<b>ESNU-10-...-P-A-CT</b>
	12	1 ... 50	<b>170 132</b>	<b>ESNU-12-...-P-A-CT</b>
	16	1 ... 50	<b>170 133</b>	<b>ESNU-16-...-P-A-CT</b>
	20	1 ... 50	<b>170 134</b>	<b>ESNU-20-...-P-A-CT</b>
	25	1 ... 50	<b>170 135</b>	<b>ESNU-25-...-P-A-CT</b>

# Standard cylinders ESNU, ISO 6432

Ordering data – Modular products



M Mandatory data					O Options →	
Module No.	Function	Piston Ø	Stroke	Cushioning	Position sensing	End cap
193 996	ESNU	8	1 ... 50	P	A	MA
193 997		10				
193 998		12				
193 999		16				
194 000		20				
194 001		25				
<b>Order example</b>						
194 002	ESNU	- 25	- 45	- P	- A	- MA

Ordering table										
Size	8	10	12	16	20	25	Condi- tions	Code	Enter code	
M Module No.	193 996	193 997	193 998	193 999	194 000	194 001				
Function	Standard cylinder, single-acting pushing, based on ISO 6432							ESNU		ESNU
Piston Ø [mm]	8	10	12	16	20	25	-...			
Stroke [mm]	1 ... 50						-...			
Cushioning	Flexible cushioning rings/pads at both ends						-P		-P	
O Position sensing	Via proximity sensor						[1]	-A		
↓ End cap	Axial air connection							-MA		

[1] A Minimum stroke: 10 mm

Transfer order code

	ESNU	-		-		-	P	-		-	
--	------	---	--	---	--	---	---	---	--	---	--

# Standard cylinders ESNU, ISO 6432

Ordering data – Modular products



## Options

Extended male thread	Shortened male thread	Female thread	Special thread	Extended piston rod
...K2	...K6	K3	"..."K5	...K8
- 30K2	-	-	- "M10"K5	- 30K8

## Ordering table

Size	8	10	12	16	20	25	Condi- tions	Code	Enter code
Extended male thread [mm]	Extended male piston rod thread 1 ... 15   1 ... 20		1 ... 25		1 ... 35		[2]	-...K2	
Shortened male thread [mm]	Shortened male piston rod thread 1 ... 4		1 ... 8					-...K6	
Female thread	Female piston rod thread -   -   -   -		(M4)   (M6)				[3]	-K3	
Special thread	Piston rod with special thread -   -   -   -		-   -		M10			-..."K5	
Extended piston rod [mm]	Extended piston rod 1 ... 50							...K8	

- [2] **K2** Not with female thread K3, shortened male thread K6
- [3] **K3** Not with special thread K5, shortened male thread K6

Transfer order code

-  -  -  -  -

# Standard cylinders DSN, ISO 6432

FESTO

Technical data

Function

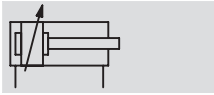
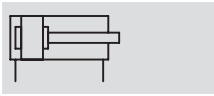

∅ - Diameter  
8 ... 25 mm

— - Stroke length  
1 ... 500 mm

Variant



S2



General technical data						
Piston ∅	8	10	12	16	20	25
Pneumatic connection	M5	M5	M5	M5	G1/8	G1/8
Piston rod thread	M4	M4	M6	M6	M8	M10x1.25
Constructional design	Piston					
	Piston rod					
	Cylinder barrel					
Cushioning	Flexible cushioning rings/pads at both ends					
	-			Pneumatic cushioning, adjustable at both ends		
Cushioning length (PPV) [mm]	-			14	17	
Type of mounting	Via accessories					
Mounting position	Any					

-||- Note: This product conforms with the ISO 1179-1 standard and the ISO 228-1 standard.

Operating conditions						
Piston ∅	8	10	12	16	20	25
Operating medium	Filtered compressed air, lubricated or unlubricated					
Operating pressure [bar]	1.5 ... 10			1 ... 10		

Ambient conditions						
Standard cylinder						
Ambient temperature [°C]	-20 ... +80					
Corrosion resistance class CRC <sup>1)</sup>	2					

1) Corrosion resistance class 2 as per Festo standard 940 070  
Components subject to moderate corrosion stress. Externally visible parts with primarily decorative surface requirements which are in direct contact with a normal industrial environment or media such as coolants or lubricating agents.

# Standard cylinders DSN, ISO 6432

Technical data

Forces [N]						
Piston Ø	8	10	12	16	20	25
Theoretical force at 6 bar, advancing <sup>1)</sup>	30	47	68	121	189	295
Theoretical force at 6 bar, retracting <sup>1)</sup>	23	40	51	104	158	247

1) The force in the advance stroke is the same as the force in the return stroke with the variant S2

Weights [g]						
Piston Ø	8	10	12	16	20	25
Product weight with 0 mm stroke	40	43	80	96	200	260
Additional weight per 10 mm stroke	2.3	2.5	4.1	4.7	7.1	10.9

## Materials

Sectional view

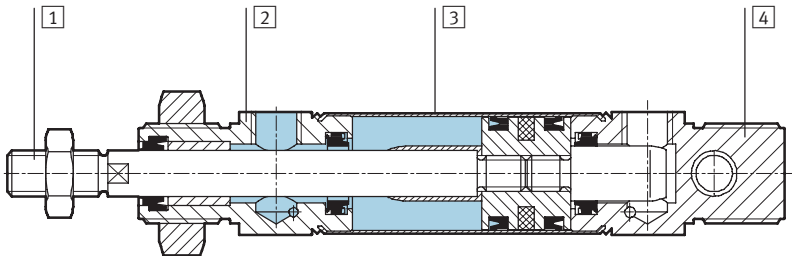

Standard cylinder	
1	Piston rod High-alloy stainless steel
2	Bearing cap Wrought aluminium alloy
3	Cylinder barrel High-alloy stainless steel
4	End cap Wrought aluminium alloy
-	Seals Polyurethane, nitrile rubber

# Standard cylinders DSN, ISO 6432

Technical data

FESTO

## Dimensions

Download CAD data → [www.festo.com](http://www.festo.com)

### Basic version

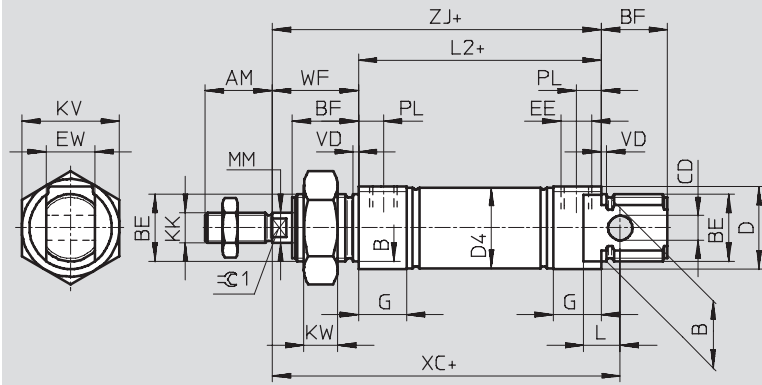

Note  
Piston rod nut is not included in scope of delivery for  $\varnothing 8 \dots 20$ .

+ = plus stroke length

### S2 – Through piston rod

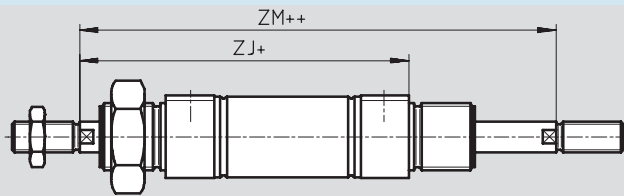

+ = plus stroke length  
++ = plus 2x stroke length

$\varnothing$ [mm]	AM	B $\varnothing$ h9	BE	BF	CD $\varnothing$ E10	D $\varnothing$	D4 $\varnothing$	EE	EW	G	KK
8	12	12	M12x1.25	12	4	15	9.3	M5	8	10	M4
10							11.3				
12							13.3				
16	16	M16x1.5	17	6	20	17.3	12		M6		
20	20	22	M22x1.5	20	8	27	21.3		G $\frac{1}{8}$	16	16
25	22			22			8	26.5			

$\varnothing$ [mm]	KV	KW	L	L2	MM $\varnothing$	PL	VD	WF	XC $\pm 1$	ZJ	ZM	$\approx 1$	
8	19	6	6	46	4	6	2	16	64	62	78.4	-	
10				50									
12	24	8	9	56	6			22		75	72		94
16				68						8	82		78
20	32	11	12	69.5	10			8.2		24	95		92
25				28	104	97.5	125.5		9				

- | - Note: This product conforms with the ISO 1179-1 standard and the ISO 228-1 standard.

# Standard cylinders DSN, ISO 6432

Technical data

Ordering data				
Type	Piston Ø [mm]	Stroke [mm]	Flexible cushioning rings/pads at both ends	
			Part No.	Type
Basic version				
	8	10	5 033	DSN-8-10-P
		25	5 034	DSN-8-25-P
		40	5 035	DSN-8-40-P
		50	5 036	DSN-8-50-P
		80	5 037	DSN-8-80-P
		100	5 038	DSN-8-100-P
	10	10	5 040	DSN-10-10-P
		25	5 041	DSN-10-25-P
		40	5 042	DSN-10-40-P
		50	5 043	DSN-10-50-P
		80	5 044	DSN-10-80-P
		100	5 045	DSN-10-100-P
	12	10	5 047	DSN-12-10-P
		25	5 048	DSN-12-25-P
		40	5 049	DSN-12-40-P
		50	5 050	DSN-12-50-P
		80	5 051	DSN-12-80-P
		100	5 052	DSN-12-100-P
		125	8 519	DSN-12-125-P
		160	5 053	DSN-12-160-P
		200	5 054	DSN-12-200-P

# Standard cylinders DSN, ISO 6432

FESTO



Technical data

Ordering data						
Type	Piston Ø [mm]	Stroke [mm]	Flexible cushioning rings/pads at both ends		Pneumatic cushioning, adjustable at both ends	
			Part No.	Type	Part No.	Type
Basic version						
	16	10	5 056	DSN-16-10-P	-	
		25	5 057	DSN-16-25-P	-	
		40	5 058	DSN-16-40-P	14 534	DSN-16-40-PPV
		50	5 059	DSN-16-50-P	14 535	DSN-16-50-PPV
		80	5 060	DSN-16-80-P	14 536	DSN-16-80-PPV
		100	5 061	DSN-16-100-P	14 537	DSN-16-100-PPV
		125	8 520	DSN-16-125-P	14 538	DSN-16-125-PPV
		160	5 062	DSN-16-160-P	14 539	DSN-16-160-PPV
		200	5 063	DSN-16-200-P	14 540	DSN-16-200-PPV
	20	10	5 065	DSN-20-10-P	-	
		25	5 066	DSN-20-25-P	-	
		40	5 067	DSN-20-40-P	8 743	DSN-20-40-PPV
		50	5 068	DSN-20-50-P	8 744	DSN-20-50-PPV
		80	5 069	DSN-20-80-P	8 745	DSN-20-80-PPV
		100	5 070	DSN-20-100-P	8 746	DSN-20-100-PPV
		125	8 521	DSN-20-125-P	8 747	DSN-20-125-PPV
		160	5 071	DSN-20-160-P	8 748	DSN-20-160-PPV
		200	5 072	DSN-20-200-P	8 749	DSN-20-200-PPV
		250	8 522	DSN-20-250-P	8 750	DSN-20-250-PPV
		300	5 073	DSN-20-300-P	8 751	DSN-20-300-PPV
		320	34 710	DSN-20-320-P	34 712	DSN-20-320-PPV
		25	10	5 075	DSN-25-10-P	-
	25		5 076	DSN-25-25-P	-	
	40		5 077	DSN-25-40-P	9 666	DSN-25-40-PPV
	50		5 078	DSN-25-50-P	9 667	DSN-25-50-PPV
	80		5 079	DSN-25-80-P	9 668	DSN-25-80-PPV
	100		5 080	DSN-25-100-P	9 669	DSN-25-100-PPV
	125		8 523	DSN-25-125-P	8 531	DSN-25-125-PPV
160	5 081		DSN-25-160-P	9 670	DSN-25-160-PPV	
200	5 082		DSN-25-200-P	9 671	DSN-25-200-PPV	
250	8 524		DSN-25-250-P	8 532	DSN-25-250-PPV	
300	5 083		DSN-25-300-P	9 672	DSN-25-300-PPV	
320	34 711		DSN-25-320-P	34 713	DSN-25-320-PPV	
400	32 298		DSN-25-400-P	32 300	DSN-25-40-PPV	
500	32 299		DSN-25-500-P	32 301	DSN-25-500-PPV	



# Standard cylinders DSN, ISO 6432

Technical data

Ordering data					
Type	Piston Ø [mm]	Stroke [mm]	Flexible cushioning rings/pads at both ends		Pneumatic cushioning, adjustable at both ends
			Part No.	Type	Part No. Type
Variable stroke lengths					
	8	1 ... 100	5 032	DSN-8-...-P	-
	10	1 ... 100	5 039	DSN-10-...-P	
	12	1 ... 200	5 046	DSN-12-...-P	
	16	1 ... 200	5 055	DSN-16-...-P	
	20	1 ... 320	5 064	DSN-20-...-P	
	25	1 ... 500	5 074	DSN-25-...-P	
Variable stroke lengths					
	16	1 ... 200	-		14 533 DSN-16-...-PPV
	20	1 ... 320	-		8 742 DSN-20-...-PPV
	25	1 ... 500	-		9 665 DSN-25-...-PPV
Variable stroke, through piston rod					
	20	10 ... 320	-		11 893 DSN-20-...-PPV-S2
	25	10 ... 500	-		11 894 DSN-25-...-PPV-S2

# Standard cylinders ESN, ISO 6432

Technical data

Function



⌀ - Diameter  
8 ... 25 mm

— - Stroke length  
1 ... 50 mm



General technical data						
Piston ⌀	8	10	12	16	20	25
Pneumatic connection	M5	M5	M5	M5	G $\frac{1}{8}$	G $\frac{1}{8}$
Piston rod thread	M4	M4	M6	M6	M8	M10x1.25
Constructional design	Piston					
	Piston rod					
	Cylinder barrel					
Cushioning	Flexible cushioning rings/pads at both ends					
Type of mounting	Via accessories					
Mounting position	Any					

— - Note: This product conforms with the ISO 1179-1 standard and the ISO 228-1 standard.

Operating conditions						
Piston ⌀	8	10	12	16	20	25
Operating medium	Filtered compressed air, lubricated or unlubricated					
Operating pressure [bar]	1.5 ... 10			1.2 ... 10		

Ambient conditions	
Standard cylinder	
Ambient temperature [°C]	-20 ... +80
Corrosion resistance class CRC <sup>1)</sup>	2

1) Corrosion resistance class 2 as per Festo standard 940 070  
Components subject to moderate corrosion stress. Externally visible parts with primarily decorative surface requirements which are in direct contact with a normal industrial environment or media such as coolants or lubricating agents.

# Standard cylinders ESN, ISO 6432

Technical data

Force [N] and impact energy [J]						
Piston $\varnothing$	8	10	12	16	20	25
Theoretical force at 6 bar, advancing	24	41	61	107	169	270
Spring return force 10 mm stroke	4.9	4.9	6.3	13.2	18.3	22.9
Spring return force 25 mm stroke	4.1	4.1	5.4	11.9	16.5	21.2
Spring return force 50 mm stroke	2.8	4.8	3.9	9.8	13.6	18.5
Impact energy at end positions	0.03	0.05	0.07	0.15	0.20	0.30

Weight [g]						
Piston $\varnothing$	8	10	12	16	20	25
Product weight with 0 mm stroke	40	43	80	96	200	260
Additional weight per 10 mm stroke	2.3	2.5	4.1	4.7	7.1	10.9

## Materials

Sectional view

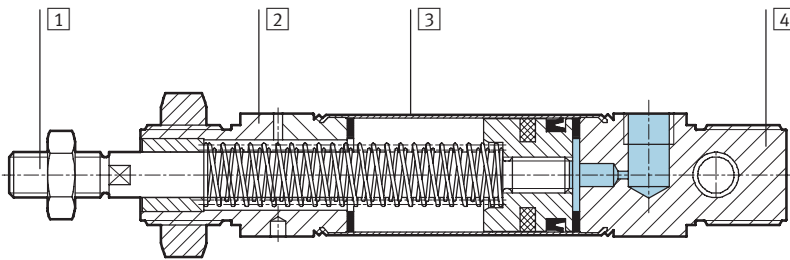

Standard cylinder		
1	Piston rod	High-alloy stainless steel
2	Bearing cap	Wrought aluminium alloy
3	Cylinder barrel	High-alloy stainless steel
4	End cap	Wrought aluminium alloy
-	Seals	Polyurethane, nitrile rubber
-	Spring	Spring steel

# Standard cylinders ESN, ISO 6432

Technical data

FESTO

## Dimensions

Download CAD data → [www.festo.com](http://www.festo.com)

Basic version

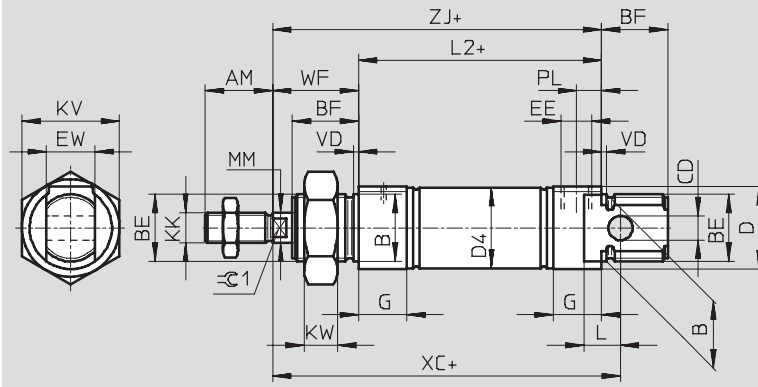

Note  
Piston rod nut is not included in scope of delivery for  $\varnothing$  8 ... 20.  
+ = plus stroke length

$\varnothing$ [mm]	AM	B $\varnothing$ h9	BE	BF	CD $\varnothing$ E10	D $\varnothing$	D4 $\varnothing$	EE	EW	G	KK
8	12	12	M12x1.25	12	4	15	9.3	M5	8	10	M4
10							11.3				
12	16	16	M16x1.5	17	6	20	13.3		12	M6	
16							17.3				
20	20	22	M22x1.5	20	8	27	21.3	G $\frac{1}{8}$	16	16	M8
25	22			22			22				26.5

$\varnothing$ [mm]	KV	KW	L	L2	MM $\varnothing$	PL	VD	WF	XC $\pm 1$	ZJ	$\approx \text{C1}$	
8	19	6	6	46	4	6	2	16	64	62	-	
10				50	6							
12	24	8	9	56				8.2	22	75	82	78
16				68								
20	32	11	12	69.5	10	24	95	104	97.5	9		
25				28								

Note: This product conforms with the ISO 1179-1 standard and the ISO 228-1 standard.

# Standard cylinders ESN, ISO 6432

Technical data

Ordering data			
Type	Stroke [mm]	Part No.	Type
Basic version			
	Ø 8 mm		
	10	5 086	ESN-8-10-P
	25	5 087	ESN-8-25-P
	50	5 088	ESN-8-50-P
	Ø 10 mm		
	10	5 089	ESN-10-10-P
	25	5 090	ESN-10-25-P
	50	5 091	ESN-10-50-P
	Ø 12 mm		
	10	5 092	ESN-12-10-P
	25	5 093	ESN-12-25-P
	50	5 094	ESN-12-50-P
	Ø 16 mm		
	10	5 095	ESN-16-10-P
	25	5 096	ESN-16-25-P
	50	5 097	ESN-16-50-P
	Ø 20 mm		
	10	5 098	ESN-20-10-P
	25	5 099	ESN-20-25-P
	50	5 100	ESN-20-50-P
	Ø 25 mm		
	10	5 101	ESN-25-10-P
	25	5 102	ESN-25-25-P
	50	5 103	ESN-25-50-P

Ordering data			
Type	Ø [mm]	Stroke [mm]	Part No. Type
Variable stroke lengths			
	8	1 ... 50	11 651 ESN-8-...-P
	10	1 ... 50	11 652 ESN-10-...-P
	12	1 ... 50	11 653 ESN-12-...-P
	16	1 ... 50	11 654 ESN-16-...-P
	20	1 ... 50	11 655 ESN-20-...-P
	25	1 ... 50	11 656 ESN-25-...-P

# Standard cylinders DSNU/DSNUP/DSN/ESNU/ESN, ISO 6432

FESTO

Accessories

## Foot mounting HBN/CRHBN

Scope of delivery:

HBN/CRHBN-...x1: 1 foot

HBN/CRHBN-...x2: 2 feet and 1 nut

Material:

HBN: Galvanised steel

CRHBN: High-alloy stainless steel

Free of copper, PTFE and silicone

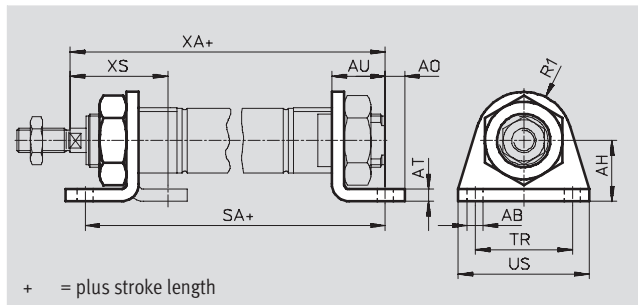

Dimensions and ordering data															
For $\varnothing$	AB	AH	AO	AT	AU	R1	SA		TR	US	XA		XS		
[mm]	$\varnothing$							-KP				-KP		-KP	
8, 10	4.5	16	5	3	11	10	68	97	25	35	73	102	24	-	
12	5.5	20	6	4	14	13	78	116	32	42	86	124	32	-	
16	5.5	20	6	4	14	13	84	122	32	42	92	130	32	-	
20	6.6	25	8	5	17	20	102	149	40	54	109	156	36	-	
25	6.6	25	8	5	17	20	103.5	151.5	40	54	114.5	162.5	40	-	

For $\varnothing$	Basic version				High corrosion protection			
	CRC <sup>1)</sup>	Weight [g]	Part No.	Type	CRC <sup>1)</sup>	Weight [g]	Part No.	Type
8, 10	2	20	5 123	HBN-8/10x1	-	-	-	-
	2	55	5 124	HBN-8/10x2	-	-	-	-
12, 16	2	40	5 125	HBN-12/16x1	4	40	161 866	CRHBN-12/16x1
	2	105	5 126	HBN-12/16x2	4	97	162 999	CRHBN-12/16x2
20, 25	2	90	5 127	HBN-20/25x1	4	55	161 867	CRHBN-20/25x1
	2	220	5 128	HBN-20/25x2	4	100	162 998	CRHBN-20/25x2

1) Corrosion resistance class 2 as per Festo standard 940 070

Components subject to moderate corrosion stress. Externally visible parts with primarily decorative surface requirements which are in direct contact with a normal industrial environment or media such as coolants or lubricating agents.

Corrosion resistance class 4 as per Festo standard 940 070

Components requiring higher corrosion resistance. Parts used with aggressive media, e.g. food or chemical industry. These applications should be supported with special tests with the media if required.

# Standard cylinders DSNU/DSNUP/DSN/ESNU/ESN, ISO 6432

Accessories

## Flange mounting FBN/CRFBN

Material:

FBN: Galvanised steel

CRFBN: High-alloy stainless steel

Free of copper, PTFE and silicone

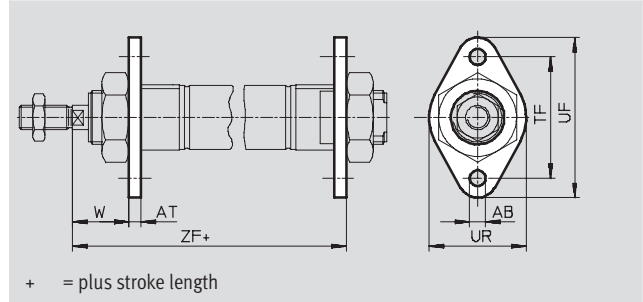

Dimensions and ordering data								
For Ø	AB	AT	TF	UF	UR	W	ZF	
[mm]	Ø							-KP
8, 10	4.5	3	30	40	25	13	65	94
12	5.5	4	40	53	30	18	76	114
16	5.5	4	40	53	30	18	82	120
20	6.6	5	50	66	40	19	97	144
25	6.6	5	50	66	40	23	102.5	150.5

For Ø	Basic version				High corrosion protection			
	CRC <sup>1)</sup>	Weight [g]	Part No.	Type	CRC <sup>1)</sup>	Weight [g]	Part No.	Type
8, 10	2	12	5 129	FBN-8/10	-	-	-	-
12, 16	2	25	5 130	FBN-12/16	4	25	161 864	CRFBN-12/16
20, 25	2	45	5 131	FBN-20/25	4	45	161 865	CRFBN-20/25

1) Corrosion resistance class 2 as per Festo standard 940 070

Components subject to moderate corrosion stress. Externally visible parts with primarily decorative surface requirements which are in direct contact with a normal industrial environment or media such as coolants or lubricating agents.

Corrosion resistance class 4 as per Festo standard 940 070

Components requiring higher corrosion resistance. Parts used with aggressive media, e.g. food or chemical industry. These applications should be supported with special tests with the media if required.

## Swivel mounting SBN

Material:

Mounting ring: Wrought aluminium alloy, anodised

Bearing: Bronze

Screws: Galvanised steel

Bracket: Steel

Cannot be used on the bearing cap in combination with bellows kit DADB.

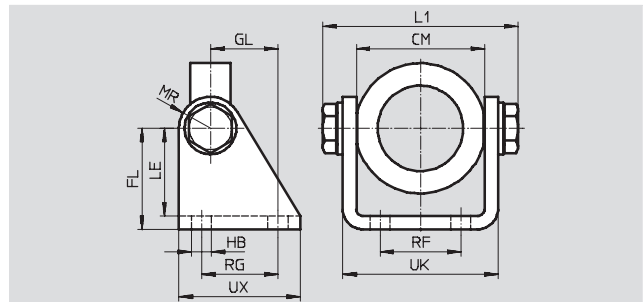

Dimensions and ordering data															
For Ø	CM	FL	GL	HB	L1	LE	MR	RF	RG	UK	UX	CRC <sup>1)</sup>	Weight	Part No.	Type
[mm]					max.								[g]		
20/25	38.1+0.4	35	20	7	60.2	31	12	20	24	46.1	40	2	200	539 927	SBN-20/25

1) Corrosion resistance class 2 as per Festo standard 940 070

Components subject to moderate corrosion stress. Externally visible parts with primarily decorative surface requirements which are in direct contact with a surrounding industrial atmosphere or media such as cooling or lubricating agents.

# Standard cylinders DSNU/DSNUP/DSN/ESNU/ESN, ISO 6432

FESTO

Accessories

## Swivel mounting WBN

Material:

Galvanised steel

Free of copper, PTFE and silicone

Cannot be used on the bearing cap in combination with bellows kit DADB.

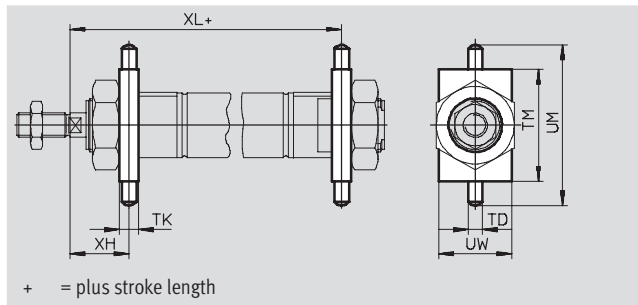

Dimensions and ordering data												
For Ø	TD	TK	TM	UM	UW	XH	XL		CRC <sup>1)</sup>	Weight	Part No.	Type
[mm]	Ø							-KP		[g]		
8, 10	4	6	26	38	20	13	65	94	2	20	<b>8 608</b>	<b>WBN-8/10</b>
12	6	8	38	58	25	18	76	114	2	50	<b>8 609</b>	<b>WBN-12/16</b>
16	6	8	38	58	25	18	82	120	2	50	<b>8 609</b>	<b>WBN-12/16</b>
20	6	8	46	66	30	20	96	143	2	70	<b>8 610</b>	<b>WBN-20/25</b>
25	6	8	46	66	30	24	101.5	149.5	2	70	<b>8 610</b>	<b>WBN-20/25</b>

1) Corrosion resistance class 2 as per Festo standard 940 070

Components subject to moderate corrosion stress. Externally visible parts with primarily decorative surface requirements which are in direct contact with a surrounding industrial atmosphere or media such as cooling or lubricating agents.

## Clevis foot LBN/CRLBN

Material:

LBN: Galvanised steel

CRLBN: High-alloy stainless steel

Free of copper, PTFE and silicone

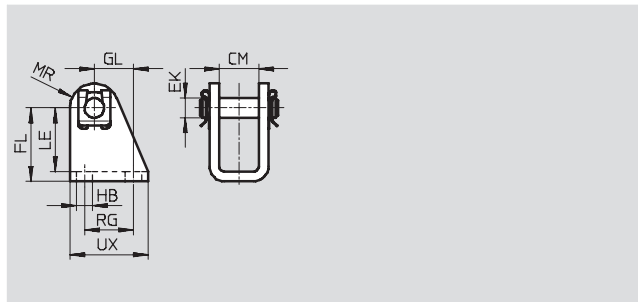
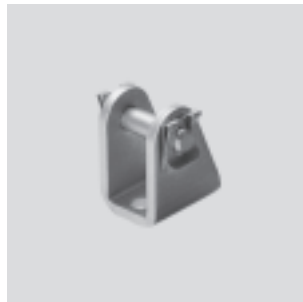

Dimensions and ordering data										
For Ø	CM	EK	FL	GL	HB	LE	MR	RG	UX	
[mm]		Ø								
8, 10	8.1	4	24 +0.3/-0.2	13.8	4.5	21.5	5	12.5	20	
12, 16	12.1	6	27 +0.3/-0.2	13	5.5	24	7	15	25	
20, 25	16.1	8	30 +0.4/-0.2	16	6.6	26	10	20	32	

For Ø	Basic version				High corrosion protection			
	CRC <sup>1)</sup>	Weight [g]	Part No.	Type	CRC <sup>1)</sup>	Weight [g]	Part No.	Type
8, 10	2	22	<b>6 057</b>	<b>LBN-8/10</b>	—	—	—	—
12, 16	2	40	<b>6 058</b>	<b>LBN-12/16</b>	4	55	<b>161 862</b>	<b>CRLBN-12/16</b>
20, 25	2	81	<b>6 059</b>	<b>LBN-20/25</b>	4	62	<b>161 863</b>	<b>CRLBN-20/25</b>

1) Corrosion resistance class 2 as per Festo standard 940 070

Components subject to moderate corrosion stress. Externally visible parts with primarily decorative surface requirements which are in direct contact with a normal industrial environment or media such as coolants or lubricating agents.

Corrosion resistance class 4 as per Festo standard 940 070





Components requiring higher corrosion resistance. Parts used with aggressive media, e.g. food or chemical industry. These applications should be supported with special tests with the media if required.



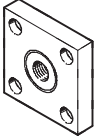
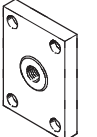

# Standard cylinders DSNU/DSNUP/DSN/ESNU/ESN, ISO 6432

FESTO

Accessories

Ordering data – Piston rod attachments				Technical data → Internet: piston rod attachments			
Designation	For Ø	Part No.	Type	Designation	For Ø	Part No.	Type
<b>Rod eye SGS</b>				<b>Rod clevis SG</b>			
	8	9 253	SGS-M4		8	6 532	SG-M4
	10				10		
	12	9 254	SGS-M6		12	3 110	SG-M6
	16				16		
	20	9 255	SGS-M8		20	3 111	SG-M8
	25	9 261	SGS-M10x1,25		25	6 144	SG-M10x1,25
<b>Coupling piece KSG</b>				<b>Coupling piece KSZ</b>			
	8	–			12	36 123	KSZ-M6
	10				16		
	12				20	36 124	KSZ-M8
	16				25	36 125	KSZ-M10x1,25
	20						
	25	32 963	KSG-M10x1,25				
<b>Self-aligning rod coupler FK</b>				<b>Hex nut MSK</b>			
	8	6 528	FK-M4		16	189 007	MSK-M16X1,5
	10				20, 25	189 009	MSK-M22X1,5
	12	2 061	FK-M6				
	16						
	20	2 062	FK-M8				
	25	6 140	FK-M10x1,25				

Ordering data – Piston rod attachments, corrosion resistant				Technical data → Internet: crsg			
Designation	For Ø	Part No.	Type	Designation	For Ø	Part No.	Type
<b>Rod eye CRSGS</b>				<b>Rod clevis CRSG</b>			
	12	195 580	CRSGS-M6		12	13 567	CRSG-M6
	16				16		
	20	195 581	CRSGS-M8		20	13 568	CRSG-M8
	25	195 582	CRSGS-M10x1,25		25	13 569	CRSG-M10x1,25

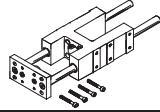
Ordering data – Guide units				Technical data → Internet: feng			
	For Ø	Stroke [mm]	With recirculating ball bearing guide		With plain-bearing guide		
			Part No.	Type	Part No.	Type	
	8, 10	1 ... 200	35 197	FEN-8/10-...-KF	35 196	FEN-8/10-...	
	12, 16	1 ... 200	33 481	FEN-12/16-...-KF	19 168	FEN-12/16-...	
	20	2 ... 250	33 482	FEN-20-...-KF	19 169	FEN-20-...	
	25	2 ... 250	33 483	FEN-25-...-KF	19 170	FEN-25-...	

## Standard cylinders DSNU/DSNUP/DSN/ESNU/ESN, ISO 6432

Accessories

**FESTO**

### Bellows kit DADB



General technical data						
Type DADB-S1-			12	16	20	25
Max. stroke range of cylinder <sup>1)</sup>	DSNU	[mm]	10 ... 50	10 ... 50	10 ... 320	10 ... 500
	ESNU <sup>2)</sup>	[mm]	–	–	10 ... 50	10 ... 50
Type of mounting	With threaded pin					
Mounting position	Any					
Resistance to media	Dust, chippings, oil, grease, fuel (→ Internet: Resistance to media)					
Ambient temperature <sup>3)</sup>		[°C]	–10 ... +80			
Corrosion resistance class CRC <sup>4)</sup>	3					

1) In combination with the bellows kit DADB

2) Slight change in spring return force

3) Note operating range of proximity sensors and cylinder

4) Corrosion resistance class 3 as per Festo standard 940 070

Components with heavy corrosion exposure. Externally visible components in direct contact with normal industrial atmosphere or media such as solvents and cleaning agents, where the surface requirement is predominantly functional.

### Materials

Sectional view

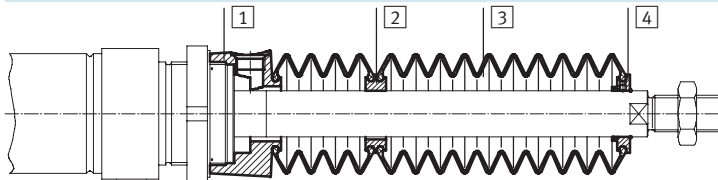

Bellows		
1	Connection	Polyamide
2	Intermediate piece	Polyamide
3	Bellows	Nitrile rubber
4	End piece	Polyamide
–	O-ring	Nitrile rubber
Note on materials		Free of copper and PTFE RoHS-compliant

Weight [g]				
Type DADB-S1- Stroke [mm]	12	16	20	25
10 ... 50	7	7	20	19
51 ... 100	–	–	32	31
101 ... 150	–	–	45	44
151 ... 200	–	–	58	57
201 ... 250	–	–	73	72
251 ... 300	–	–	85	84
301 ... 350	–	–	100	98
351 ... 400	–	–	–	109
401 ... 450	–	–	–	124
451 ... 500	–	–	–	136

## Standard cylinders DSNU/DSNUP/DSN/ESNU/ESN, ISO 6432

Accessories

### Speed of travel $v$ as a function of tube length $l$



The bellows kit is a leak-free system. To prevent unwanted media from being drawn in, the supply and exhaust air must be ducted via a venting

hole in the connection part **1**. The pressure generated in the bellows kit by the positioning motion is primarily defined by speed of travel

and tubing length. The recommended tubing length based on the travel speed of the drive can be read from the graph.

#### Advancing

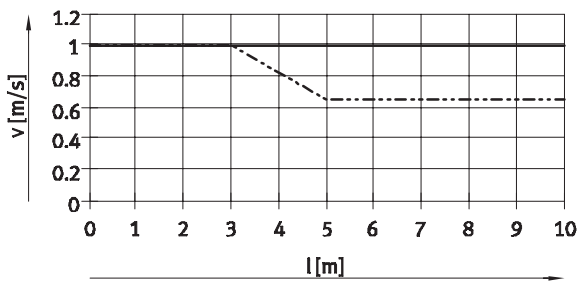

—  $\varnothing$  12/16  
- - -  $\varnothing$  20/25

#### Retracting

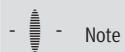
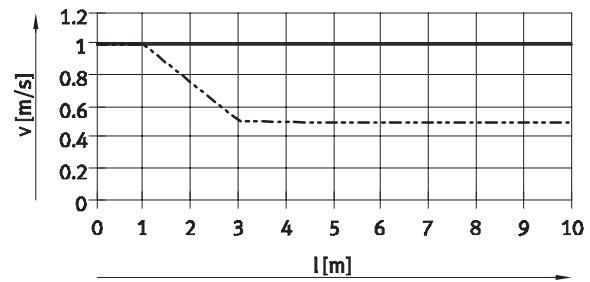

The push-in fittings opposite must be used for the venting hole. Silencers can be used as an alternative. This reduces the travel speed slightly.

#### Tubing length and push-in fitting for venting hole

$\varnothing$ [mm]	Tubing O.D. [mm]	Push-in fitting	
		Part No.	Type
12, 16, 20, 25	6	153 317	QSM-M5-6-I
		537 014	QS-F-M5-6-I
		533 845	QS-F-M5-6H
		533 875	QS-F-M5-6

**Standard cylinders DSNU/DSNUP/DSN/ESNU/ESN, ISO 6432**

Accessories

**Dimensions**

Download CAD data → [www.festo.com](http://www.festo.com)

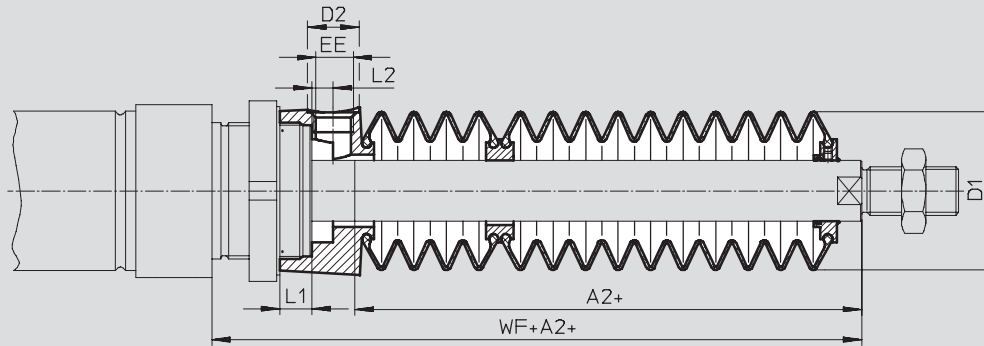

Ø Stroke [mm]	12/16							20						
	A2 <sup>1)</sup>	D1 max.	D2	EE	L1	L2	WF+A2	A2 <sup>1)</sup>	D1 max.	D2	EE	L1	L2	WF+A2
10 ... 50	23	22	8.5	M5	5	3.2	45	22	29	8.5	M5	4.2	2.7	46
51 ... 100	-						-	34						58
101 ... 150	-						-	47						71
151 ... 200	-						-	60						84
201 ... 250	-						-	75						99
251 ... 300	-						-	86						110
301 ... 350	-						-	101						125
351 ... 400	-						-	-						-
401 ... 450	-						-	-						-
451 ... 500	-						-	-						-

Ø Stroke [mm]	25						
	A2 <sup>1)</sup>	D1 max.	D2	EE	L1	L2	WF+A2
10 ... 50	22	29	8.5	M5	4.2	2.7	50
51 ... 100	34						62
101 ... 150	47						75
151 ... 200	60						88
201 ... 250	75						103
251 ... 300	86						114
301 ... 350	101						129
351 ... 400	112						140
401 ... 450	127						155
451 ... 500	138						166

1) The dimension corresponds to the K8 value (extended piston rod) of the drive

## Standard cylinders DSNU/DSNUP/DSN/ESNU/ESN, ISO 6432

Accessories

### Ordering data – Bellows kit

An extended piston rod (order code K8) is required when using a bellows kit  
→ Ordering data – Modular products.

The necessary dimensions for K8 as a function of piston diameter and cylinder stroke as well as the corresponding bellows kit are indicated in the table below:

### Order example:

Selected standard cylinder:

DSNU-25-320-PPV-A-MQ-...

The dimension for the corresponding K8 value (see table):  
101 mm

Complete type code for standard cylinder:

DSNU-25-320-PPV-A-MQ-...-101K8

The corresponding bellows kit:

DADB-S1-25-S301-350

Cylinder data			Bellows kit		Cylinder data			Bellows kit	
∅	Stroke	Dimension for K8	Part No.	Type	∅	Stroke	Dimension for K8	Part No.	Type
[mm]	[mm]	[mm]			[mm]	[mm]	[mm]		
12	10 ... 50	23	553 391	DADB-S1-12-S10-50	16	10 ... 50	23	553 399	DADB-S1-16-S10-50
20	10 ... 50	22	553 407	DADB-S1-20-S10-50	25	10 ... 50	22	553 421	DADB-S1-25-S10-50
	51 ... 100	34	553 409	DADB-S1-20-S51-100		51 ... 100	34	553 423	DADB-S1-25-S51-100
	101 ... 150	47	553 411	DADB-S1-20-S101-150		101 ... 150	47	553 425	DADB-S1-25-S101-150
	151 ... 200	60	553 413	DADB-S1-20-S151-200		151 ... 200	60	553 427	DADB-S1-25-S151-200
	201 ... 250	75	553 415	DADB-S1-20-S201-250		201 ... 250	75	553 429	DADB-S1-25-S201-250
	251 ... 300	86	553 417	DADB-S1-20-S251-300		251 ... 300	86	553 431	DADB-S1-25-S251-300
	301 ... 320	101	553 419	DADB-S1-20-S301-350		301 ... 350	101	553 433	DADB-S1-25-S301-350
				351 ... 400		112	553 435	DADB-S1-25-S351-400	
				401 ... 450		127	553 437	DADB-S1-25-S401-450	
				451 ... 500		138	553 439	DADB-S1-25-S451-500	

 Note

Can only be used with piston ∅ 20 and 25 of the single-acting standard cylinder ESNU.

# Standard cylinders DSNU/DSNUP/DSN/ESNU/ESN, ISO 6432



FESTO

Accessories

Ordering data – Proximity sensors, round design, magneto-resistive							Technical data → Internet: smto	
	Assembly	Switching output	Electrical connection		Cable length [m]	Connection direction	Part No.	Type
			Cable	Plug M8				
N/O contact								
	Via accessories	PNP	3-wire	–	2.5	In-line	152 836	SMTO-4U-PS-K-LED-24
			–	3-pin	–	In-line	152 742	SMTO-4U-PS-S-LED-24
		NPN	3-wire	–	2.5	In-line	152 837	SMTO-4U-NS-K-LED-24
			–	3-pin	–	In-line	152 743	SMTO-4U-NS-S-LED-24

Ordering data – Proximity sensors, round design, magnetic reed							Technical data → Internet: smeo	
	Assembly	Electrical connection		Cable length [m]	Connection direction	Part No.	Type	
		Cable	Plug M8					
N/O contact								
	Via accessories	3-wire	–	2.5	In-line	36 198	SMEO-4U-K-LED-24	
			5	In-line	175 401	SMEO-4U-K5-LED-24		
		–	3-pin	–	In-line	151 526	SMEO-4U-S-LED-24-B	



Ordering data – Proximity sensors, round design, magnetic reed, corrosion resistant							Technical data → Internet: crsmeo	
	Assembly	Electrical connection		Cable length [m]	Connection direction	Part No.	Type	
		Cable	Plug M8					
N/O contact								
	Via accessories	3-wire	–	2.5	In-line	161 775	CRSMEO-4-K-LED-24	



Ordering data – Mounting kits for proximity sensors SMEO/SMTO/CRSMEO							Technical data → Internet: smbr	
Designation	For Ø	Part No.	Type	Designation	For Ø	Part No.	Type	
Mounting kit SMBR				Mounting kit CRSMBR, corrosion resistant				
	8	19 272	SMBR-8		8	–	–	
	10	19 273	SMBR-10		10	–	–	
	12	19 274	SMBR-12		12	164 581	CRSMBR-12	
	16	19 275	SMBR-16		16	164 582	CRSMBR-16	
	20	19 276	SMBR-20		20	164 583	CRSMBR-20	
	25	19 277	SMBR-25		25	164 584	CRSMBR-25	

# Standard cylinders DSNU/DSNUP/DSN/ESNU/ESN, ISO 6432

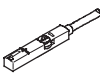
FESTO

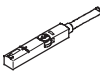
Accessories

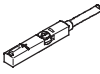
Ordering data – Proximity sensors for T-slot, magneto-resistive						Technical data → Internet: smt	
	Type of mounting	Switching output	Electrical connection	Cable length [m]	Part No.	Type	
<b>N/O contact</b>							
	Insertable in the slot from above, flush with the cylinder profile	PNP	Cable, 3-wire	2.5	543 867	SMT-8M-PS-24V-K-2,5-OE	
			Plug M8x1, 3-pin	0.3	543 866	SMT-8M-PS-24V-K-0,3-M8D	
			Plug M12x1, 3-pin	0.3	543 869	SMT-8M-PS-24V-K-0,3-M12	
	Insertable in the slot lengthwise, flush with the cylinder profile	PNP	Cable, 3-wire	2.5	543 870	SMT-8M-NS-24V-K-2,5-OE	
			Plug M8x1, 3-pin	0.3	543 871	SMT-8M-NS-24V-K-0,3-M8D	
<b>N/C contact</b>							
	Insertable in the slot lengthwise, flush with the cylinder profile	PNP	Cable, 3-wire	7.5	543 873	SMT-8M-PO-24V-K7,5-OE	



Ordering data – Proximity sensors for T-slot, magnetic reed						Technical data → Internet: sme	
	Type of mounting	Switching output	Electrical connection	Cable length [m]	Part No.	Type	
<b>N/O contact</b>							
	Insertable in the slot from above, flush with the cylinder profile	Contacting	Cable, 3-wire	2.5	543 862	SME-8M-DS-24V-K-2,5-OE	
				5.0	543 863	SME-8M-DS-24V-K-5,0-OE	
			Cable, 2-wire	2.5	543 872	SME-8M-ZS-24V-K-2,5-OE	
	Insertable in the slot lengthwise, flush with the cylinder profile	Contacting	Plug M8x1, 3-pin	0.3	543 861	SME-8M-DS-24V-K-0,3-M8D	
			Cable, 3-wire	2.5	150 855	SME-8-K-LED-24	
<b>N/C contact</b>							
	Insertable in the slot lengthwise, flush with the cylinder profile	Contacting	Cable, 3-wire	7.5	160 251	SME-8-O-K-LED-24	



Ordering data – Mounting kits for proximity sensors SME/SMT-8					Technical data → Internet: smbr	
Designation	For Ø				Part No.	Type
<b>Mounting kit SMBR-8</b>						
	8				175 091	SMBR-8-8
	10				175 092	SMBR-8-10
	12				175 093	SMBR-8-12
	16				175 094	SMBR-8-16
	20				175 095	SMBR-8-20
	25				175 096	SMBR-8-25

# Standard cylinders DSNU/DSNUP/DSN/ESNU/ESN, ISO 6432



FESTO

Accessories

Ordering data – Proximity sensors for slot type 10 (C-slot), magneto-resistive						Technical data → Internet: smt
	Type of mounting	Switching output	Electrical connection, connection direction	Cable length [m]	Part No.	Type
N/O contact						
	Insertable in the slot from above, flush with the cylinder profile	PNP	Cable, 3-wire, in-line	2.5	525 915	SMT-10F-PS-24V-K2,5L-OE
			Plug M8x1, 3-pin, in-line	0.3	525 916	SMT-10F-PS-24V-K0,3L-M8D
			Plug M8x1, 3-pin, angled	0.3	526 675	SMT-10F-PS-24V-K0,3Q-M8D
	Insertable in slot lengthwise	PNP	Plug M8x1, 3-pin, in-line	0.3	173 220	SMT-10-PS-SL-LED-24
			Cable, 3-wire, in-line	2.5	173 218	SMT-10-PS-KL-LED-24

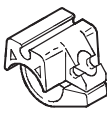
Ordering data – Proximity sensors for C-slot, magnetic reed						Technical data → Internet: sme
	Type of mounting	Switching output	Electrical connection, connection direction	Cable length [m]	Part No.	Type
N/O contact						
	Insertable in the slot from above, flush with the cylinder profile	Contacting	Plug M8x1, 3-pin, in-line	0.3	525 914	SME-10F-DS-24V-K0,3L-M8D
			Cable, 3-wire, in-line	2.5	525 913	SME-10F-DS-24V-K2,5L-OE
			Cable, 2-wire, in-line	2.5	526 672	SME-10F-ZS-24V-K2,5L-OE
	Insertable in slot lengthwise	Contacting	Plug M8x1, 3-pin, in-line	0.3	173 212	SME-10-SL-LED-24
			Cable, 3-wire, in-line	2.5	173 210	SME-10-KL-LED-24



Ordering data – Mounting kits for proximity sensors SME/SMT-10					Technical data → Internet: smbr
Designation	For Ø		Part No.	Type	
Mounting kit SMBR-10					
	8		175 101	SMBR-10-8	
	10		173 227	SMBR-10-10	
	12		175 102	SMBR-10-12	
	16		173 228	SMBR-10-16	
	20		175 103	SMBR-10-20	
	25		175 104	SMBR-10-25	

Ordering data – Connecting cables					Technical data → Internet: nebu
	Electrical connection, left	Electrical connection, right	Cable length [m]	Part No.	Type
	Straight socket, M8x1, 3-pin	Cable, open end, 3-wire	2.5	541 333	NEBU-M8G3-K-2.5-LE3
			5	541 334	NEBU-M8G3-K-5-LE3
	Straight socket, M12x1, 5-pin	Cable, open end, 3-wire	2.5	541 363	NEBU-M12G5-K-2.5-LE3
			5	541 364	NEBU-M12G5-K-5-LE3
	Angled socket, M8x1, 3-pin	Cable, open end, 3-wire	2.5	541 338	NEBU-M8W3-K-2.5-LE3
			5	541 341	NEBU-M8W3-K-5-LE3
	Angled socket, M12x1, 5-pin	Cable, open end, 3-wire	2.5	541 367	NEBU-M12W5-K-2.5-LE3
			5	541 370	NEBU-M12W5-K-5-LE3



# Standard cylinders DSNU/DSNUP/DSN/ESNU/ESN, ISO 6432

Accessories

Ordering data – One-way flow control valves				Technical data → Internet: grl			
	Port		Material	Part No.	Type		
	Thread	For tubing O.D.					
<b>For exhaust air</b>							
	M5	3	Metal design	<b>193 137</b>	<b>GRLA-M5-QS-3-D</b>		
		4		<b>193 138</b>	<b>GRLA-M5-QS-4-D</b>		
		6		<b>193 139</b>	<b>GRLA-M5-QS-6-D</b>		
	G1/8	3		<b>193 142</b>	<b>GRLA-1/8-QS-3-D</b>		
		4		<b>193 143</b>	<b>GRLA-1/8-QS-4-D</b>		
		6		<b>193 144</b>	<b>GRLA-1/8-QS-6-D</b>		
		8		<b>193 145</b>	<b>GRLA-1/8-QS-8-D</b>		
		<b>For supply air</b>					
		M5		3	Metal design	<b>193 153</b>	<b>GRLZ-M5-QS-3-D</b>
				4		<b>193 154</b>	<b>GRLZ-M5-QS-4-D</b>
6			<b>193 155</b>	<b>GRLZ-M5-QS-6-D</b>			
G1/8		3	<b>193 156</b>	<b>GRLZ-1/8-QS-3-D</b>			
		4	<b>193 157</b>	<b>GRLZ-1/8-QS-4-D</b>			
		6	<b>193 158</b>	<b>GRLZ-1/8-QS-6-D</b>			
		8	<b>193 159</b>	<b>GRLZ-1/8-QS-8-D</b>			

Ordering data – One-way flow control valves, corrosion resistant				Technical data → Internet: crgla	
	Port		Material	Part No.	Type
	Thread	For push-in fitting			
<b>For exhaust air</b>					
	M5	CRQS/CRQSL/CRQST	Electrolytically polished stainless steel casting	<b>161 403</b>	<b>CRGRLA-M5-B</b>
	G1/8			<b>161 404</b>	<b>CRGRLA-1/8-B</b>

 Note

Only push-in fittings or one-way flow control valves with cylindrical connecting thread (M or G thread) may be used for the compressed air ports in conjunction with the DSNU.