



Electrolux Bitola

MARTIRANJE-ZIGOSUVANJE NA MATERIJALI

Ovoј crtez e sopstvenost na Electrolux-Bitola.Bez negovo pismeno odobruvanje istot nesmee da se prepisuva ,umnozuva niti kopira bez soglasnost od Elctroluks vo sprovitvo se snosat posledici vo smislana clenovite 163 i 164 od kriticniot zakon R.M. (повреда на авторско право)



ROLLER MARKING MACHINES

Адреса: ул. Браќа Минџови бр.18,Стара Царина Битола
Адреса: ул. Айосџил Ѓусларов 1-а Г.Г.Ц.Бунџаковец Скопје
Тел/Факс: 047/203-900; 203-330; 070/237-108
Тел/Факс:02/329 8 130;070/237 198
www.elektroluks.com.mk , electrolux@mt.net.mk

® Elektroluks is registered trademark of Elektroluks companies in Macedonia and other countries



Electrolux Bitola

MARTIRANJE-ZIGOSUVANJE NA MATERIJALI

Ovo je crtez e sopstvenost na Electrolux-Bitola.Bez negovo pismeno odobruvanje istot nesmee da se prepisuva ,umozuva niti kopira bez soglasnost od Electroluks vo sprofitno se snosat posledici vo smislana clenovite 163 i 164 od kriticniot zakon R.M. (povreda na avtorsko pravo)

SMALL DIAMETERS



MODEL MB 41N

- The manual roller marking machine for the perfect marking of round components, either solid or hollow from 8-65mm diameter.
- Solid round components are marked using roller support, type S2R. Thin walled hollow parts are marked using mandrel support type S1R.

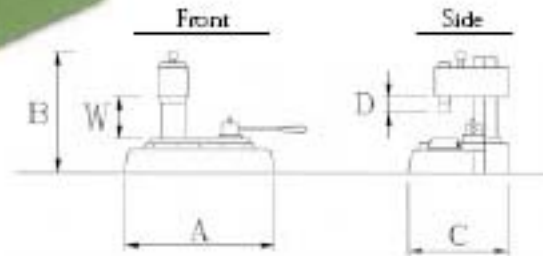

MODEL MB 41E

- Motorized version of the machine MB41N.
- With geared motor connected to 380V 3 phase, 50 Hz.
- Mounted on bench, model TE.
- Twin push button safety system is integrated in the bench.
- Suitable for marking round components from 8-65 mm diameter.

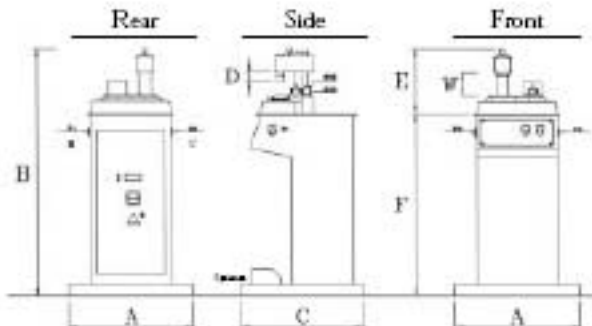

Адреса: ул. Браќа Минџови бр.18,Стара Царина Битола
Адреса: ул. Айосџил Ѓусларов 1-а Г.Г.Ц.Бунџаковец Скопје
Тел/Факс: 047/203-900; 203-330; 070/237-108
Тел/Факс:02/329 8 130;070/237 198
www.electroluks.com.mk , electrolux@mt.net.mk



Electrolux Bitola

MARTIRANJE-ZIGOSUVANJE NA MATERIJALI

MEDIUM SIZED DIAMETERS



MODEL MB 71E

- Electrically operated roller marking machine for marking, graduating, numbering of variously shaped round components up to a maximum of 110 mm diameter.
- Simple setting of the depth of mark.
- The table is fitted with spring washers to even out differences in diameter and to achieve constant depth of mark.
- Operation is via electrical twin push buttons. All electrical components are built into the bench, type TC.

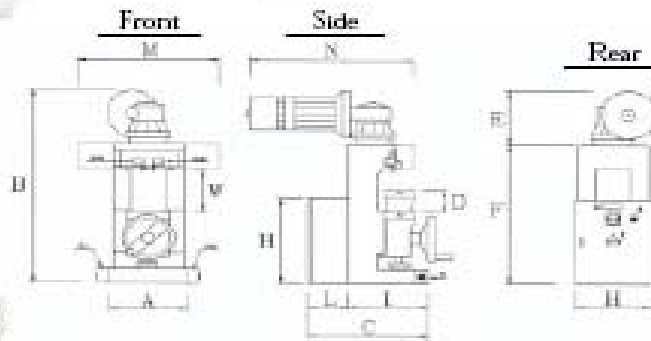

MODEL MB 71EP

- Electrically operated machine with additional pneumatic movement of the table. This ensures perfect and uniform marking every time.
- PLC control of all movements.

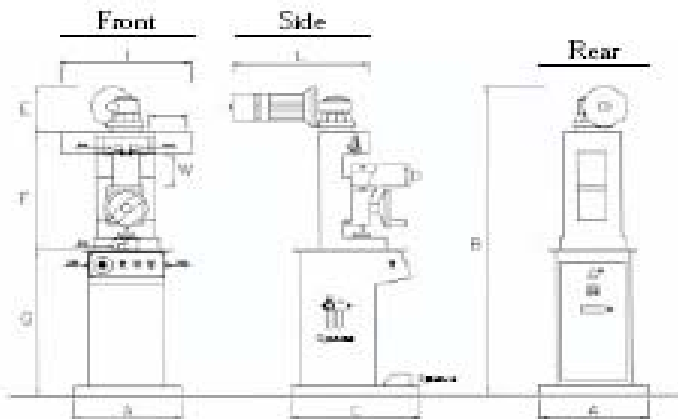

Ovoј crtez e sopstvenost na Electrolux-Bitola.Bez negovo pismeno odobruvanje istot nesmee da se prepisuva ,umozuva niti kopira bez soglasnost od Electroluks vo sprofitno se snosat posledici vo smislana clenovite 163 i 164 od kriticniot zakon R.M. (povreda na avtorsko pravo)

Адреса: ул. Браќа Минџови бр.18,Стара Царина Битола
 Адреса: ул. Айосџил Ѓусларов 1-а Г.Г.Ц.Бунџаковец Скопје
 Тел/Факс: 047/203-900; 203-330; 070/237-108
 Тел/Факс:02/329 8 130;070/237 198
www.electroluks.com.mk , electrolux@mt.net.mk

Electroluks is registered trademark of Elektroluks companies in Macedonia and other countries



Electrolux Bitola

MARTIRANJE-ZIGOSUVANJE NA MATERIJALI

Ovoј crtez e sopstvenost na Electrolux-Bitola.Bez negovo pismeno odobruvanje istot nesmee da se prepisuva , umnozuva niti kopira bez soglasnost od Elctroluks vo sprofitno se snosat posledici vo smislana clenovite 163 i 164 od kriticniot zakon R.M. (povreda na avtorsko pravo)

MEDIUM SIZED DIAMETERS



MODEL MB 71N

- Manually operated machine for marking, graduating, numbering etc. of cylindrical, conical or flat components.
- Maximum diameter of round components 110 mm
- Simple setting of depth of mark.
- The table is fitted with spring washers to even out differences in diameter and to achieve consistent depth of mark.
- Large range of accessories available.

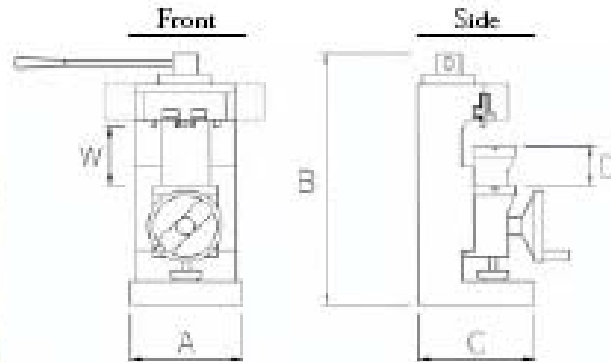

MODEL MB 71UE

- Electrical marking unit with slide movement via a geared motor.
- For marking, graduating, numbering of cylindrical, conical and flat components.
- Linear marking takes place by rolling.
- Specially designed for integration in production lines.

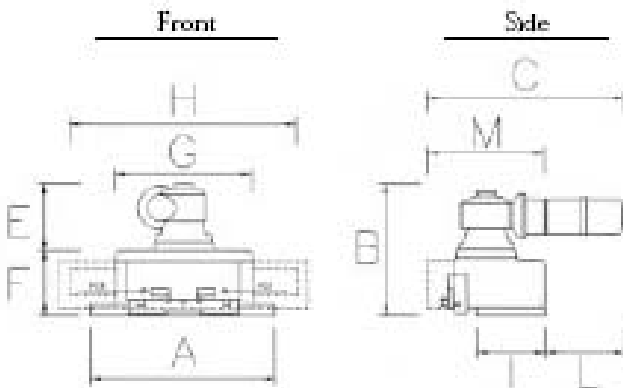

Адреса: ул. Браќа Минџови бр.18,Стара Царинаја Битола
 Адреса: ул. Айосџол Ѓусларов 1-а Г.Г.Ц.Бунџаковец Скопје
 Тел/Факс: 047/203-900; 203-330; 070/237-108
 Тел/Факс:02/329 8 130;070/237 198
www.electroluks.com.mk , electrolux@mt.net.mk

Electroluks is registered trademark of Elektroluks companies in Macedonia and other countries



Electrolux Bitola

MARTIRANJE-ZIGOSUVANJE NA MATERIJALI

MODEL MB 7ICE

Continuous, repeated marking on bars, hexagonals, tubes and profiled material etc. The symbols, logos or text are rolled into the material using a marking roller of 60 mm diameter.

Production rate: 6 metre/min.
Output can be doubled by using two rollers simultaneously.

CONTINUOUS ROLLER MARKING

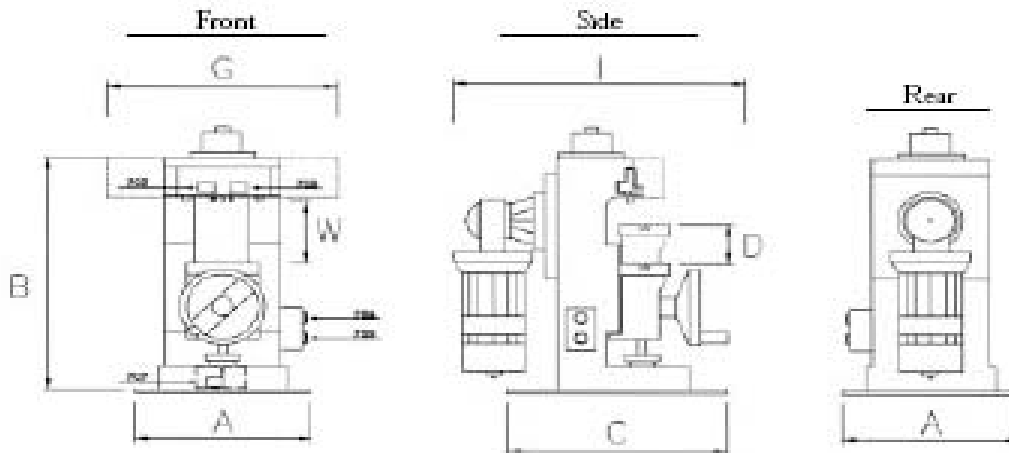

Ovoј crtez e sopstvenost na Electrolux-Bitola.Bez negovo pismeno odobruvanje istot nesmee da se prepisuva , umnozava niti kopira bez soglasnost od Elctroluks vo sprofitno se snosat posledici vo smislana clenovite 163 i 164 od kriticniot zakon R.M. (povreda na avtorsko pravo)

Адреса: ул. Браќа Минџови бр.18,Стара Царина, Битола
Адреса: ул. Айосџол Ѓусларов 1-а Г.Г.Ц.Бунџаковец Скопје
Тел/Факс: 047/203-900; 203-330; 070/237-108
Тел/Факс:02/329 8 130;070/237 198
www.electroluks.com.mk , electrolux@mt.net.mk

Electroluks is registered trademark of Elektroluks companies in Macedonia and other countries



Electrolux Bitola

MARTIRANJE-ZIGOSUVANJE NA MATERIJALI

Support S2R and S2R mini

The twin roller supports S2R and S2R mini are used on roller marking machines to rotate the part to be marked. The marking head causes the part to be rotated during the marking process.

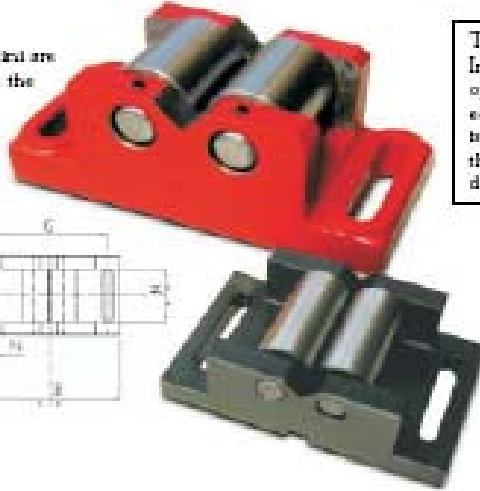
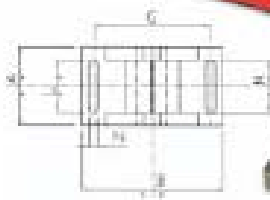
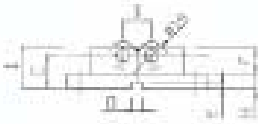

The supports designed by Automator International are intended to help the operator ensure that the force is always equally applied and that a perfect mark is produced every time. This is due to the accuracy with which every item is designed and tested.

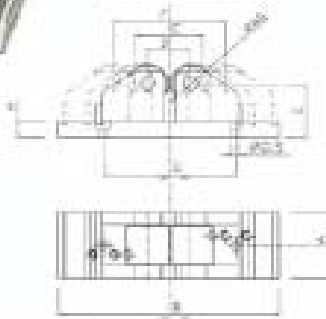

Support S2R - adjustable

With support S2R-adjustable, it is possible to set the two rollers to suit the exact diameter of the parts to be marked.

Mandrel Support S1R and S1R mini

The mandrel supports S1R and S1R mini have been designed specifically for marking thin walled tubular components.

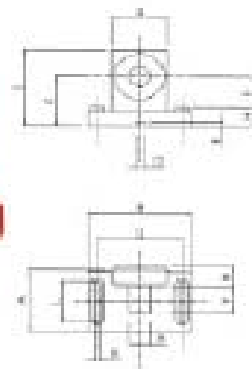

Ovoj crtez e sopstvenost na Electrolux-Bitola.Bez negovo pismeno odobruvanje istot nesmee da se prepisiva ,umozuva niti kopira bez soglasnost od Electroluks vo sprofitno se snosat posledici vo smislana clenovite 163 i 164 od kriticniot zakon R.M. (povreda na avtorsko pravo)

Адреса: ул. Браќа Минџови бр.18,Стара Царина, Битола
Адреса: ул. Айосџол Ѓусларов 1-а Г.Г.Ц.Бунџаковец Скопје
Тел/Факс: 047/203-900; 203-330; 070/237-108
Тел/Факс:02/329 8 130;070/237 198
www.electroluks.com.mk , electrolux@mt.net.mk

Electroluks is registered trademark of Elektroluks companies in Macedonia and other countries



Electrolux Bitola

MARTIRANJE-ZIGOSUVANJE NA MATERIJALI

TECHNICAL DATA

Type of support	Machines model	A	B	C	D	E	F	G	H	I	L	M	N	O	X and Y	Ø Roller
S1R	MB410N - 410E MB710N - 710E - 710EP MB710E	80	175	74	75	/	48	135	26	109	62	52	8	/	on request	/
S1R Mini	MB410N - 410E MB710N - 710E - 710EP MB710E	60	98	51	52	4	23	80	18	74	40	30	6	8	on request	/
S2R	MB410N - 410E MB710N - 710E - 710EP MB710E	80	170	48	42,5	/	44	140	19	64	65	50	13	/	/	30
S2R Mini	MB410N - 410E MB710N - 710E - 710EP MB710E	60	100	25	20,2	4	22	80	10	32	40	40	6,5	8	/	10
S2R Adjustable	MB710N - 710E - 710EP MB710E	80	250	65	40	50	119	130	20	/	/	/	/	/	/	48
S3R	MB710E	110	170	42	40	/	40	150	20	60	15	70	10	/	/	42
SR100	MB710N - 710E - 710EP MB710E	58	73	92	97	67	43	/	/	83	/	/	/	/	/	/

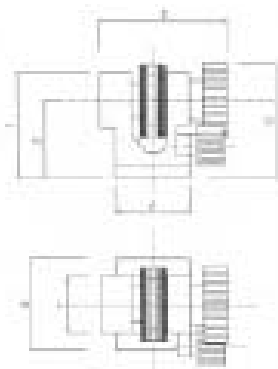

Roller support SR100

This roller support serves to take the circular typesholder, type RPC 101 (see page 7). It is also possible to fit 60 mm diameter dies engraved with special logos or text.

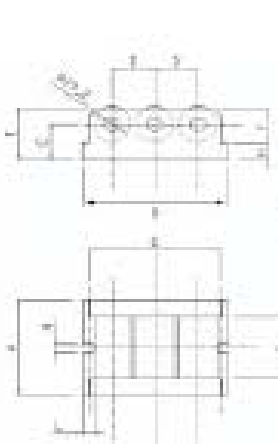

Roller support S3R

This roller support is only used on the roller marking machine, model MB710E, and guides the bar through the machine for continuous marking. The centre roller can be engraved to allow marking on two faces simultaneously.

Ovo je crtez e sopstvenost na Electrolux-Bitola.Bez negovo pismeno odobruvanje istot nesmee da se prepisiva ,umozuova niti kopira bez soglasnost od Electroluks vo sprofitno se snosat posledici vo smislana clenovite 163 i 164 od kriticniot zakon R.M. (povreda na avtorsko pravo)

Адреса: ул. Браќа Минџови бр.18,Стара Царинаја Битола
 Адреса: ул. Айосџил Ѓусларов 1-а Г.Ц.Бунџаковец Скопје
 Тел/Факс: 047/203-900; 203-330; 070/237-108
 Тел/Факс:02/329 8 130;070/237 198
www.elektroluks.com.mk , electrolux@mt.net.mk

Electroluks is registered trademark of Elektroluks companies in Macedonia and other countries



Electrolux Bitola

MARTIRANJE-ZIGOSUVANJE NA MATERIJALI

Ovo je crtež e sopstvenost na Electrolux-Bitola. Bez negovo pismeno odobruvanje istot nesmee da se prepisuva, umnozuva niti kopira bez soglasnost od Electroluks vo sprotivno se snosat posledici vo smislana clenovite 163 i 164 od Krivicniot zakon R.M. (povreda na avtorsko pravo)

TECHNICAL SPECIFICATIONS

MODEL	DIMENSIONS											TECHNICAL DATA														
	A	B	C	D	E	F	G	H	I	L	M	N	O	P	X	Y	Z	W	Max. Dia. (mm)	Weight (kg)	Gap Between Columns (mm)	Motor Rating (kw)	Motor Rating (V)	T* Max (mm)	Struts of table	Air Pressure (bar)
	MB 4IN	255	300	240	30	-	-	-	-	-	-	-	-	-	-	-	-	-	125	65	35	-	-	-	-	100
MB 4IE	600	1.000	600	30	300	700	-	-	-	-	-	-	-	-	-	-	-	125	65	110	-	0,18	380	-	100	-
MB 7IN	340	830	310	125	-	-	-	-	-	-	-	-	-	-	-	-	-	235	110	126	130	-	-	10	180	-
MB 7IE	300	1.000	900	125	300	730	330	450	330	600	500	-	-	-	-	-	-	235	110	138	180	0,55	380	10	180	-
MB 7IEP	600	1.700	600	125	280	730	700	-	480	500	-	-	-	-	-	-	-	235	110	230	180	0,55	380	10	180	6-8
MB 7ICE	340	800	310	125	-	-	480	-	530	-	-	-	-	-	-	-	-	235	80	155	190	0,55	380	10	-	-
MB 7IEE	400	600	500	-	250	160	255	425	130	250	215	-	-	-	-	-	-	-	50	50	-	0,55	380	-	180	-
MB 7IE 90°	530	1.170	1.000	-	500	190	730	-	910	380	750	190	190	480	470	350	440	-	600/630	360	-	0,55	380	-	290	-
MB 7IEP 90°	530	1.170	1.000	-	500	190	730	-	910	380	750	190	190	480	470	350	440	-	600/630	360	-	0,55	380	-	290	6-8
MB 7IE	730	1.385	660	-	280	685	820	-	480	500	-	-	-	-	-	-	-	-	1000	300	130	0,55	380	-	180	-
MB 7IEP	730	1.385	660	-	280	685	820	-	480	500	-	-	-	-	-	-	-	-	1000	300	130	0,55	380	-	180	6-8

*We reserve the right to amend specifications without notice.

Адреса: ул. Браќа Минџови бр.18, Стара Царина, Битола
 Адреса: ул. Айстойл Ѓусларов 1-а ГТЦ. Бунџаковец Скопје
 Тел/Факс: 047/203-900; 203-330; 070/237-108
 Тел/Факс: 02/329 8 130; 070/237 198
www.electroluks.com.mk, electrolux@mt.net.mk

Electroluks is registered trademark of Elektroluks companies in Macedonia and other countries



Electrolux Bitola

MARTIRANJE-ZIGOSUVANJE NA MATERIJALI

Ovo je crtež e sopstvenost na Electrolux-Bitola. Bez negovo pismeno odobruvanje istiot nesmee da se prepisuva, umnozuva niti kopira bez soglasnost od Electroluks vo sprofitno se snosat posledici vo smislana clenovite 163 i 164 od kriticniot zakon R.M. (povreda na avtorsko pravo)

TECHNICAL SPECIFICATIONS

MODEL	DIMENSIONS												TECHNICAL DATA													
	A	B	C	D	E	F	G	H	I	L	M	N	O	P	X	Y	Z	W	Max. Dia. (mm)	Weight (kg)	Gap Between Columns (mm)	Motor Rating (kW)	Motor Rating (V)	°T Plus (mm)	Stroke of table	Air Pressure (bar)
MB 4IN	295	300	240	30	-	-	-	-	-	-	-	-	-	-	-	-	-	125	65	35	-	-	-	-	100	-
MB 4IE	600	1.000	600	300	700	-	-	-	-	-	-	-	-	-	-	-	-	125	65	110	-	0,18	380	-	100	-
MB 7IN	340	430	310	125	-	-	-	-	-	-	-	-	-	-	-	-	-	235	110	126	130	-	-	10	180	-
MB 7IE	360	1.000	500	125	200	730	350	450	370	600	500	-	-	-	-	-	-	235	110	138	190	0,55	380	10	180	-
MB 7IEP	600	1.700	600	125	200	730	700	-	480	600	-	-	-	-	-	-	-	235	110	200	190	0,55	380	10	180	6-8
MB 7ICE	340	430	340	125	-	-	480	-	570	-	-	-	-	-	-	-	-	235	90	155	190	0,55	380	10	-	-
MB 7IUE	400	600	560	-	200	100	255	425	130	215	-	-	-	-	-	-	-	-	-	50	-	-	-	-	180	-
MB 7IE 90°	530	1.170	1.000	-	500	190	750	-	910	360	750	190	190	480	470	350	440	-	600/630	360	-	0,55	380	-	200	-
MB 7IEP 90°	530	1.170	1.000	-	500	190	750	-	910	360	750	190	190	480	470	350	440	-	600/630	360	-	0,55	380	-	200	6-8
MB 7IE	720	1.385	650	-	280	685	820	-	490	540	-	-	-	-	-	-	-	-	1000	300	120	0,55	380	-	180	-
MB 7IEP	730	1.385	650	-	280	685	820	-	480	560	-	-	-	-	-	-	-	-	1000	300	180	0,55	380	-	180	6-8

We reserve the right to amend specifications without notice.

Адреса: ул. Браќа Минџови бр.18, Стара Царинаја Битола
 Адреса: ул. Айстойл Ѓусларов 1-а Г.Ц. Буњаковец Скопје
 Тел/Факс: 047/203-900; 203-330; 070/237-108
 Тел/Факс: 02/329 8 130; 070/237 198
www.electroluks.com.mk, electrolux@mt.net.mk

Electroluks is registered trademark of Elektroluks companies in Macedonia and other countries



Electrolux Bitola

MARTIRANJE-ZIGOSUVANJE NA MATERIJALI

Ovoј crtez e sopstvenost na Electrolux-Bitola.Bez negovo pismeno odobruvanje istot nesmee da se prepisuva , umozuva niti kopira , bez soglasnost od Elctroluks vo sprofitno se snosat posledici vo smislana clenovite 163 i 164 od kriticniot zakon R.M. (povreda na avtorsko pravo)

TYPEHOLDERS

An enormous range of typeholders of both standard and special design is available to resolve any marking application. The linear 1, 2 and 3 line typeholders as well as the circular typeholders all are provided with tapped hole at the rear to take the required adaptor. Because of this feature Automator typeholders can be mounted on any model of impact press or roller marking machine.



ADAPTOR PLATES

These serve to attach the typeholder to the various roller marking machines.

NUMBERING HEADS

These are ideal for marking of frequently changing numbers or sequentially incrementing serial numbers; a numbering head can be supplied for every character size and shape of component. Special numbering heads with spacer wheels, slots for holding interchangeable steel types etc. can be supplied on request. Available as two models:

- MB2 automatic
- MB14 manual



MB 14



MB 2

Height of standard character size:



Адреса: ул. Браќа Минџови бр.18, Стара Царина Битола
 Адреса: ул. Айосџол Ѓусларов 1-а Г.Ц.Бунџаковец Скопје
 Тел/Факс: 047/203-900; 203-330; 070/237-108
 Тел/Факс:02/329 8 130;070/237 198
www.elektroluks.com.mk , electrolux@mt.net.mk

Electroluks is registered trademark of Elektroluks companies in Macedonia and other countries



Electrolux Bitola

MARTIRANJE-ZIGOSUVANJE NA MATERIJALI

Ovoј crtez e sopstvenost na Electrolux-Bitola.Bez negovo pismeno odobruvanje istof nesmee da se prepisuva ,umozuva nifi kopira bez soglasnost od Elctroluks vo sprofitno se snosat posledici vo smislana clenovite 163 i 164 od kriticniot zakon R.M. (povreda na avtorsko pravo)



FONT SETS

Automated steel types are of exceptional quality incorporating as they do 50 years' experience. They are made from specially selected steel, which guarantees a long life time.

The most modern production methods ensures perfect centering and exact dimensional tolerances. Standard font sets with or without a typeset holder contain:

- 100 characters
- 20 blanks
- Tweezers and allen key

A A A a

- Type of characters:
- standard sharp face
 - multi-dot
 - rounded
 - flat face
 - hot marking
 - lower case

Height of standard character sizes

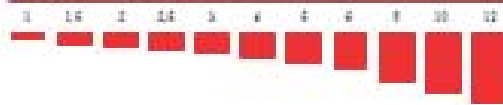

ENGRAVED STAMPS & DIES

Special dies and punches to any shape with perfect representation of logos or script are made to customers' requirements from special steel. Many years of experience guarantees highest quality and closest tolerances.



Height of standard character sizes



BANCHIES

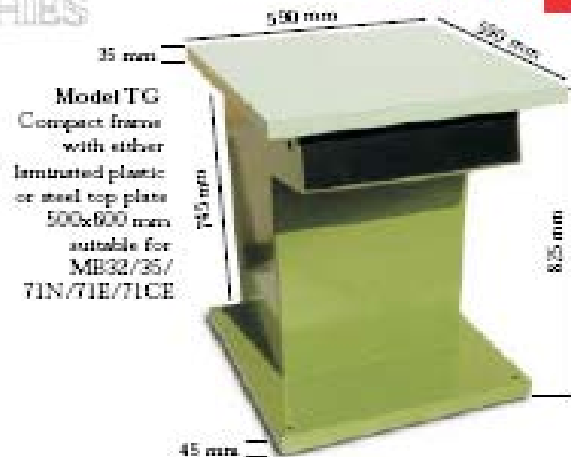

Адреса: ул. Браќа Минџови бр.18,Стара Царинаја Битола
 Адреса: ул. Ајосџил Ѓусларов 1-а Г.Г.Г.Бунџаковец Скопје
 Тел/Факс: 047/203-900; 203-330; 070/237-108
 Тел/Факс:02/329 8 130;070/237 198
www.electroluks.com.mk , electrolux@mt.net.mk

Electroluks is registered trademark of Elektroluks companies in Macedonia and other countries



Electrolux Bitola

MARTIRANJE-ZIGOSUVANJE NA MATERIJALI

SPECIAL APPLICATIONS

Ovoј crtez e sopstvenost na Electrolux-Bitola.Bez negovo pismeno odobruvanje istot nesmee da se prepisuva ,umozuva niti kopira bez soglasnost od Elctroluks vo sprofitno se snosat posledici vo smislana clenovite 163 i 164 od kriticniot zakon R.M. (povreda na avtarsko pravo)



MARKING OF FIRE EXTINGUISHER BODIES

The sheet metal, after it has been rolled and welded is marked with the following information:

- Supplier's name
- Supplier's code
- Full capacity
- Date of manufacture
- Sequential serial number

All this information is marked in one operation using a MB76EP fitted with a special numbering head with type-holder attached. Marking time is less than 3 seconds.

High pressure valve body marked on a MB 76EP



MARKING OF SAFETY VALVES AND FLANGES

All valves have to be marked with their own specific details: date, pressure, volume, manufacturer etc. Certification regulations require that the valve bodies must be marked with unalterable data.



Flange marked on a MB 76EP30"



SPECIAL APPLICATION USING A ROLLER MARKER

Roller marking of motor plugs for diesel motors with automatic loading and unloading. Special tooling with component fixating.

Roller marker MB41E combined with automatic feeding system

Адреса: ул. Браќа Минџови бр.18,Стара Царинаја Битола
Адреса: ул. Айосџил Ѓусларов 1-а ГТЦ.Бунџаковец Скопје
Тел/Факс: 047/203-900; 203-330; 070/237-108
Тел/Факс:02/329 8 130;070/237 198
www.electroluks.com.mk , electrolux@mt.net.mk

Electroluks is registered trademark of Elektroluks companies in Macedonia and other countries