



# ELEKTROLUKS

## INDUSTRIJA ZA GREAČI

### GKG - 1

Greac za boiler



*ELEKTROLUKS*

### GKG - 2

Greac za boiler



*ELEKTROLUKS*

### GKG - 3

Greac za boiler



*ELEKTROLUKS*

### GKG - 4

Greac za boiler



*ELEKTROLUKS*

### GKG - 5

Greac za boiler

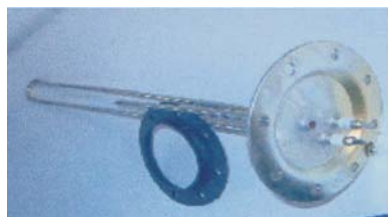

*ELEKTROLUKS*



# ELEKTROLUKS

INDUSTRIJA ZA GREAOČI

## GKG - 1

Greac za boiler



ELEKTROLUKS

## GKG - 2

Greac za boiler



ELEKTROLUKS

## GKG - 3

Greac za boiler



ELEKTROLUKS

## GKG - 4

Greac za boiler



ELEKTROLUKS

## GKG - 5

Greac za boiler



ELEKTROLUKS



# ЕЛЕКТРОЛУКС

INDUSTRIJA ZA GREAOČI

## GKG - 1

Greac za boiler

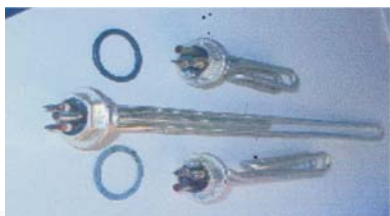

ELEKTROLUKS

## GKG - 2

Greac za boiler

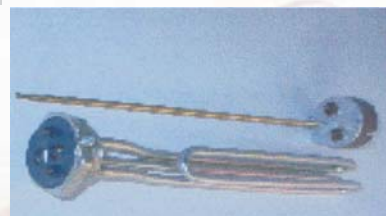

ELEKTROLUKS





# ELEKTROLUKS

## INDUSTRIJA ZA GREAČI

### GKT - 6

Greač 5/4  
1000W - 4000W  
230V



ELEKTROLUKS

### GKT - 3

Radijatorski Greač 5/4  
1000W - 4000W  
230V



ELEKTROLUKS

### GKK - 7

Greač 5/4  
1000W - 4000W  
230V



ELEKTROLUKS

### GB - 1

Greač 5/4  
1500W - 4000W  
230V



ELEKTROLUKS

### GKK - 8

Greač so kapa 5/4  
1000W - 4000W  
230V

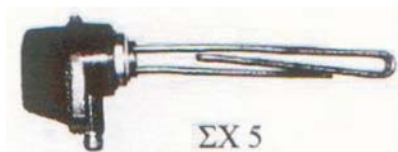

ELEKTROLUKS



# ELEKTROLUKS

## INDUSTRIJA ZA GREAČI

### GKT - 4/4

Greač 5/4  
3 x 2000W  
230V



ELEKTROLUKS

### GKT - 4/6

Greač 5/4  
2 x 3000W  
230V



ELEKTROLUKS

### GKT - 9

Greač 5/4  
2 x 2250W  
230V



ELEKTROLUKS

### GKT - 10

Greač 2" / 4000W  
230V

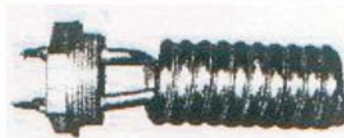

ELEKTROLUKS

### GKT - 12

Greač 5/4  
2000W / 230V  
20cm



ELEKTROLUKS

### GKT - 11

Greač 5/4  
2000W / 230V  
18.5cm



ELEKTROLUKS



# ELEKTROLUKS

## INDUSTRIJA ZA GREAČI

### GKM - 1/1

Greač 3x1500W  
230V  
39cm



ELEKTROLUKS

### GKM - 1/2

Greač 3x2000W  
230V  
39cm



ELEKTROLUKS

### GKM - 6

Greač kafemat  
3 x 1500W  
230V  
34cm

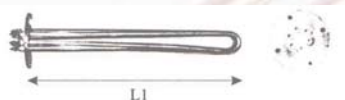

ELEKTROLUKS

### GKM - 7

Greač kafemat  
3 x 1000W  
230V  
27cm



ELEKTROLUKS

### GKM - 8

Greač kafemat  
3 x 1333W  
230V  
29cm



ELEKTROLUKS



# ELEKTROLUKS

## INDUSTRIJA ZA GREAČI

### GKM - 6

Greač 2600W / 230V  
26cm / 5.5cm



ELEKTROLUKS

### GKM - 5/3

Greač 2600W / 230V  
29cm / 6cm

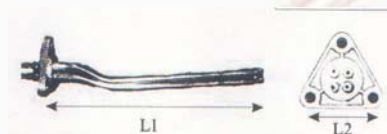

ELEKTROLUKS

### GKM - 2/3

Greač 2600W / 230V  
28.5cm / 7.5cm



ELEKTROLUKS

### GKM - 1/3

Greač 2000W / 230V  
20.5cm / 7.5cm



ELEKTROLUKS

### GKM - 2/2

Greač 2000W / 230V  
16cm / 5.5cm

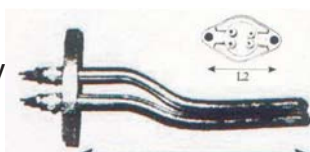

ELEKTROLUKS

### GKG - 2

Greač 2000W / 230V  
13cm / 6cm

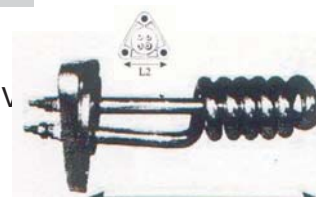

ELEKTROLUKS



# ELEKTROLUKS

## INDUSTRIJA ZA GREAČI

### GTO - 1

Greač toster  
1600W / 230V  
26.5cm / 14.5cm

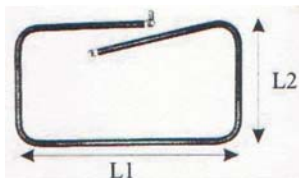

ELEKTROLUKS

### GTO - 13

Greač toster  
1300W / 115cm  
23.5cm / 10.5cm



ELEKTROLUKS

### GTO - 14

Greač toster  
1300W / 115cm  
23.5cm / 10.5cm

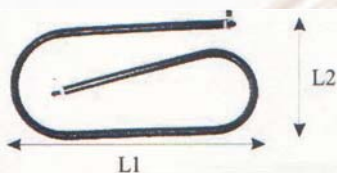

ELEKTROLUKS





# ELEKTROLUKS

## INDUSTRIJA ZA GREAČI

### GF - 8

Greač friteza 5/4  
3 x 1500W  
230V  
29cm / 9cm / 5cm

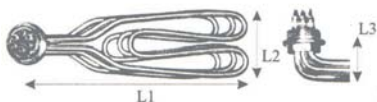

**ELEKTROLUKS**

### GF - 9

Greač friteza 5/4  
3 x 2000W  
230V  
29cm / 9cm / 5cm

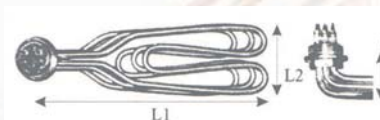

**ELEKTROLUKS**

### GF - 7

Greač friteza 5/4  
2500W - 3000W  
230V  
19.5cm / 23.5cm

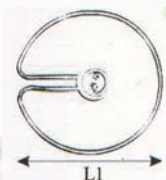

**ELEKTROLUKS**

### GF - 8

Greač za pici  
"Ergulj"  
1500W/ F6.5

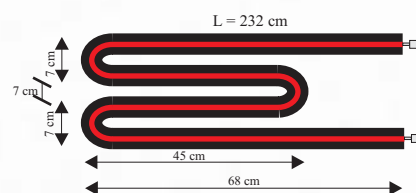

**ELEKTROLUKS**



# ELEKTROLUKS

## INDUSTRIJA ZA GREAČI

### GG - 1

Greač za giro  
 watt volt L1  
 1100 230 23cm  
 1500 230 32cm  
 1800 230 34cm  
 2000 230 40cm

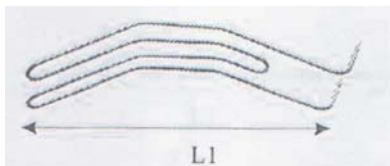

**ELEKTROLUKS**

### GG - 2

Greač za giro  
 watt volt L1  
 1300 230 27cm  
 1800 230 34cm  
 2000 230 40cm

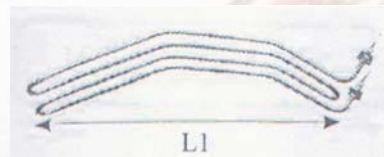

**ELEKTROLUKS**

### GG - 3

Greač za giro  
 watt volt L1  
 1600 230 26cm  
 1800 230 31cm

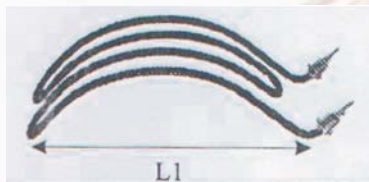

**ELEKTROLUKS**



# ЕЛЕКТРОЛУКС

## INDUSTRIJA ZA GREAČI



Стаклено - керамичките шпоретски грејни плочи користат топлински грејни елементи. Принципот на работа на овие грејни плочи е базиран на користење на намотани грејни жици монтирани во еден изолиран помошен сад вметнат во друг метален сад во облик на тава.

Целокупниот овај склоп се монтира под стаклената керамичка шпоретска плоча. Грејната жица има средна работна температура од  $1000^{\circ}\text{C}$ . Термостатот врши температурна заштита на стаклената плоча од надминување на  $600^{\circ}\text{C}$ .

Неодамнешните технолошки иновации имаат управување за делумна замена на грејната жица со халогена ламба со инфрацрвен енергетски спектар. Грејните жици односно изолацијата се дизајнирани да не го запираат инфрацрвеното зрачење насочено нагоре, но го редуцира колку што е можно повеќе страничното, а со тоа осигурува една висока ефикасност. Овие грејни елементи овозможуваат апаратите да постигнат работна температура на шпоретската плоча за многу кратко време.

### Структура:

- 1) канал за грејната жица; 2) Високо отпорен сад со изолација од температура, материјалот има мала топлинска проводливост, на сметка на хемискиот стабилен материјал; 3) термостат за температурна заштита од температури повисоки од  $600^{\circ}\text{C}$ ; 4) халоген сијалица, специјално дизајнирана за готварски функции, која гарантира минимум 5000 работни часови.

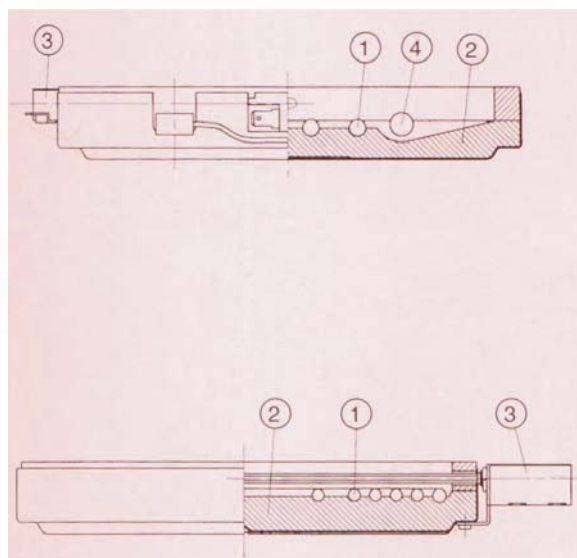



# ЕЛЕКТРОЛУКС

INDUSTRIJA ZA GREAOI

ELEKTROLUKS

## ЕКОНОМИЧНО ЗАТОПЛУВАЊЕ НА ВОДА SPA Heating Units



NEW



Основни технички спецификации:

- Грејно тело Ni-Cr легура INCOLOY 825, која нуди зголемена отпорност од корозија.
- Ниска густина на енергијата ( $< 7W/cm^2$ ) што нуди зголемен работен век на греачот.
- Далечинска контролна кутија за температурно поставување од  $5 - 45^{\circ}C/95^{\circ}C$ .
- Разновидна снага:  $200W - 9kW$  на  $230/380V$
- Целокупна апаратура е опремена со 3 м долго гумирано кабел ( $3 \times 2.5/5 \times 2.5$ ) со приклучок погоден за надворешна употреба.
- Потребна сигурност. Висока изолациона отпорност ( $>500$  мегаоми) за превентива од струјни удари.
- Намена: за парно греење, аквариуми и затоплување на базени.

Address: ul. Braka Mingovi br.18, 7000 Bitola, R.Macedonia; Tel: +389 47 203-330 Faks: +389 47 203-900  
[www.elektroluks.com.mk](http://www.elektroluks.com.mk); [elek-palenzo@mt.net.mk](mailto:elek-palenzo@mt.net.mk)



ФАБРИКА ЗА ЕЛЕКТРИЧНИ ГРЕАЧИ И АПАРАТИ ЗА ДОМАКИНСТВО

# ELEKTROLUKK

5

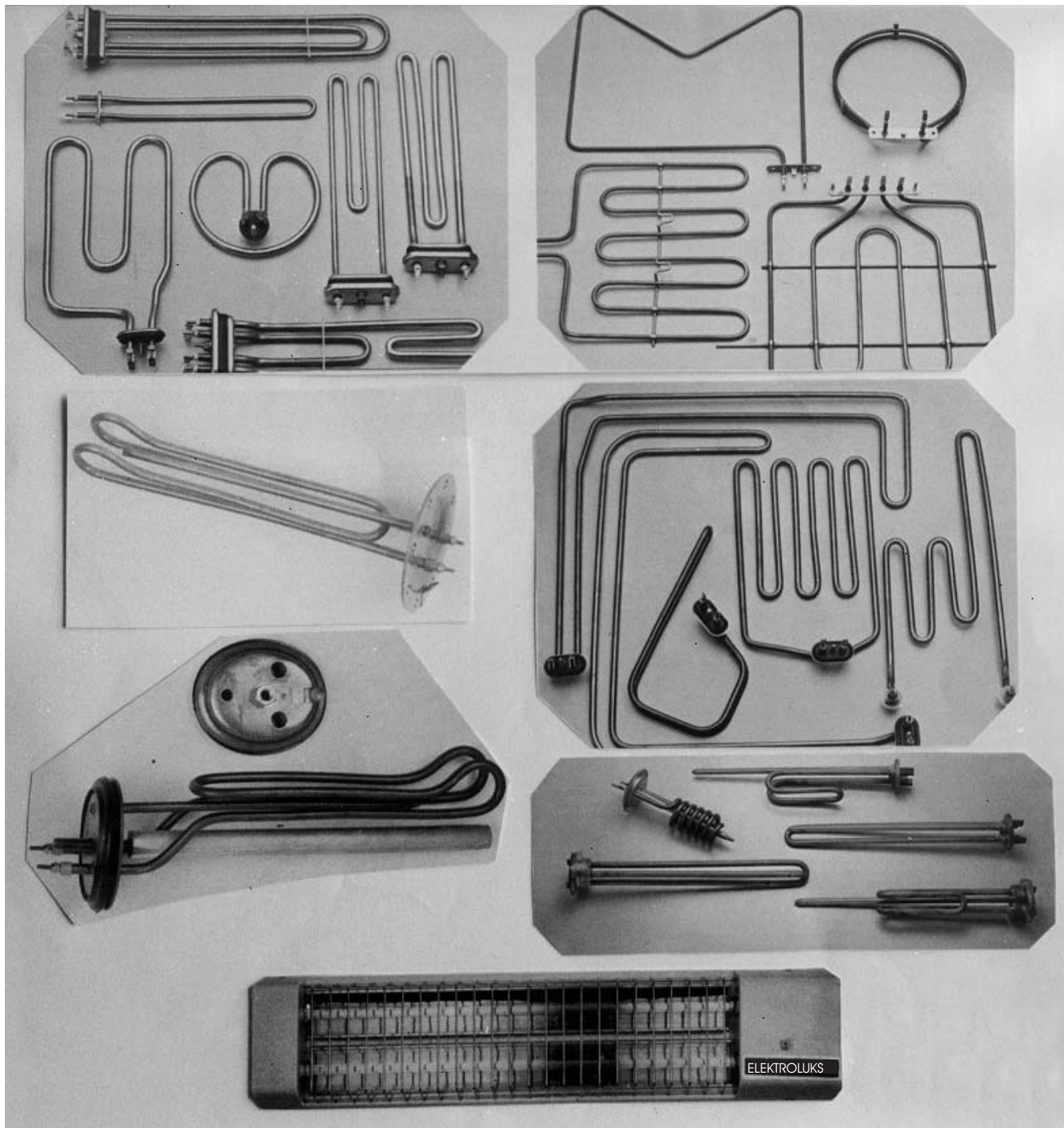

**Grea~i od standarden tip i specijalni grea~i po pora~ka,  
izraboteni po {vedska tehnologija, KANTHAL i  
po standardi na Evropskata zaednica so 6 mese~na garancija.**

Servis i prodavnica:  
Bra}a Mingovi 18, Bitola  
(stara ~ar{ija)  
tel./faks: 097 / 30-633, 227-913  
Fabrika i prodavnica na golemo:  
Dame Gruev 177, Bitola  
(nas. mal pariz)  
tel./faks: 097 / 30-877-49-067

Zastapnik:

057



# ELEKTROLUKS

- FABRIKA ZA GREANJE

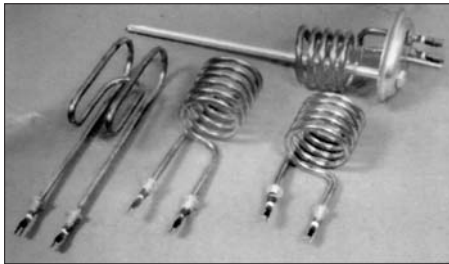

## GB - 2000

Snaga: 2000 W, napon: 220 V  
Namena: bojler od 50 do 80 l.

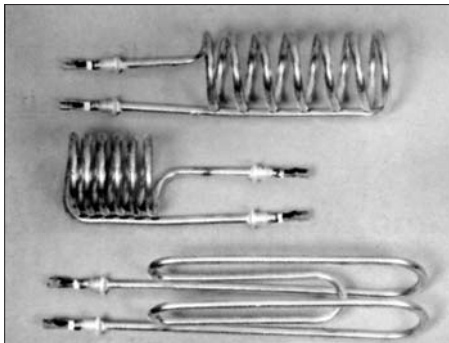

## GB - 3000

Snaga: 3000 W, napon: 220 V  
Namena: bojler od 50 do 80 l.

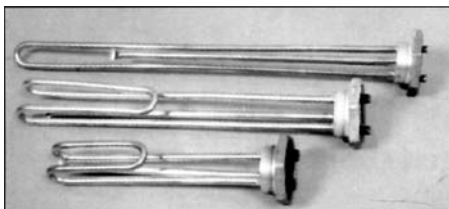

## GB - 1200 - 2000

Snaga: 1200 - 2000 W, napon: 220 V  
Namena: grejanje za italijanski bojler

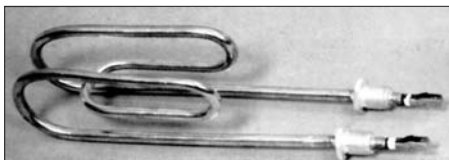

## GB - 2000 MEBO

Snaga: 2000 W, napon: 220 V  
Namena: bojler E "Mebo"

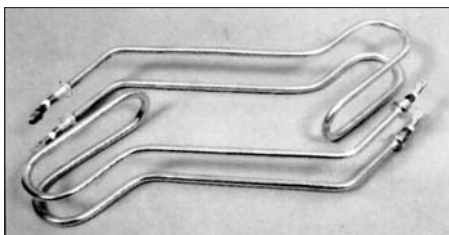

## GB - 2000

Snaga: 2000 W, napon: 220 V  
Namena: za bojler u velikim prostorima



## GB - 2000

Snaga: 2000 W, napon: 220 V  
Namena: bojler "MK" Krajevo

Servis i prodavnica:  
Bra}a Mingovi 18, Bitola  
(stara ~ar{ija)

tel./faks: 097 / 30-633

Fabrika i prodavnica na golemo:

Dame Gruev 177, Bitola

(nas. mal pariz)

tel./faks: 097 / 30-877

Zastapnik:



# ELEKTROLUKS

- FABRIKA ZA GREJAČE I

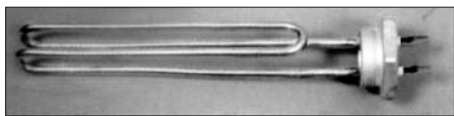

## GB - 2000 - 5/4"

Snaga: 2000 W, napon: 220 V  
Namena: bojler



## GPB - 2000

Snaga: 2000 W, napon: 220 V  
Namena: proto~en bojler Kon~ar



## GPB - 2000

Snaga: 2000 W, napon: 220 V  
Namena: proto~en bojler Standard Sutjeska

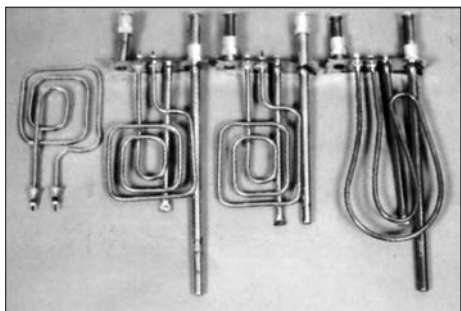

## GPB - 2000

Snaga: 2000 W, napon: 220 V  
Namena: proto~en bojler Tiki



## GB - 2000 so izmenuva~

Snaga: 2000 W, napon: 220 V  
Namena: greja~ i izmenuva~ na toplina  
dol`ina na cevka 3000 mm,  $\varnothing$  12 mm.  
za vgraduvawe vo bojler

Servis i prodavnica:  
Bra}a Mingovi 18, Bitola  
(stara ~ar{ija)  
tel./faks: 097 / 30-633  
Fabrika i prodavnica na golemo:  
Dame Gruev 177, Bitola  
(nas. mal pariz)  
tel./faks: 097 / 30-877

Zastapnik:



# ELEKTROLUKS

- FABRIKA ZA GREANJE I

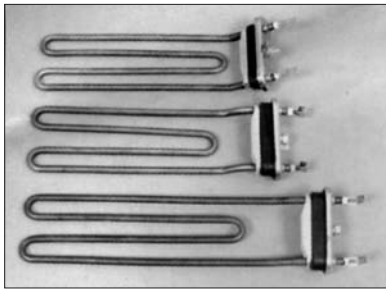

## GMP - 2100 - 2800

Snaga: 2100, 2300, 2400, 2800 W,  
napon: 220 V

Namena: mašini za perewe  
Gorewe, Obodin, El Nič

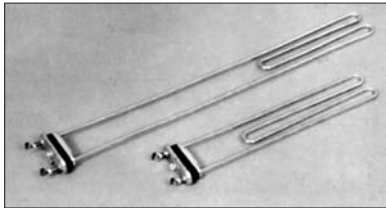

## GMP - 3000 - 4000

Snaga: 3000 i 4000 W, napon: 220 V  
Namena: mašini za perewe Primat

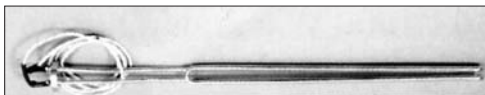

## GMP - 4000

Snaga: 3000 i 4000 W, napon: 380 V  
Namena: mašini za perewe Primat

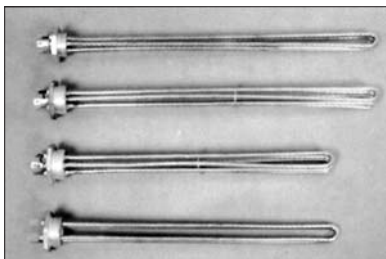

## GK - 2000 - 9000

Snaga: 2h1000, 2h1500, 2h2000, 3h2000,  
3h3000 W i drugi kombinacii,

napon: 220 i 380 V

Prirubnica: 5/4, 6/4 i sprema barawe  
Namena: kotel za centralno greewe

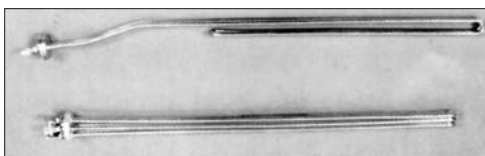

## GK - 5000 - 7500

Snaga: 2 h 5000 W, napon: 380 V  
3 h 2500 W, napon: 220 V

Namena: kotel za centralno greewe Končar



## GK - 6000

Snaga: 3 h 2000 W, napon: 220 V

Namena: kotel za centralno greewe El Nič

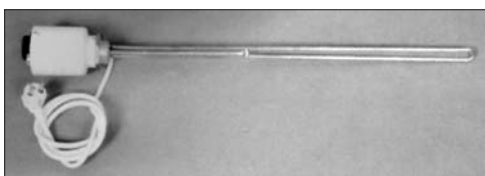

## PAL - 1500 - 2000

Snaga: 1500 i 2000 W, napon: 220 V

Namena: vgraduvawe vo radiatora za  
centralno greewe

Servis i prodavnica:  
Braća Mingovi 18, Bitola  
(stara čaršija)

tel./faks: 097 / 30-633

Fabrika i prodavnica na golemo:

Dame Gruev 177, Bitola

(nas. mal pariz)

tel./faks: 097 / 30-877

Zastapnik:





# ELEKTROLUKS

- FABRIKA ZA GREJANJE

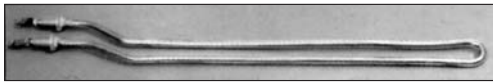

## GKM - 1250

Snaga: 1250 W, napon: 220 Æ  
Namena: kafemat

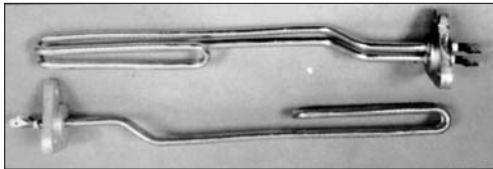

## GKM - 1250 - 2000

Snaga: 1250 i 2000 W, napon: 220 Æ  
Namena: kafemat

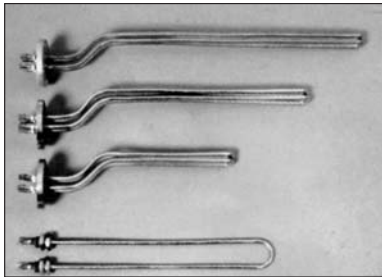

## GKM - 1000 - 3600

Snaga: 1000, 2 h 1200, 2 h 1400  
2 h 1600, 2 h 1800 W, napon: 220 Æ  
Namena: kafemat "Borec"

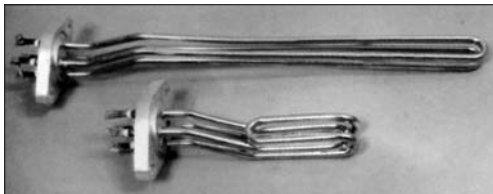

## GKM - 2500 - 2600

Snaga: 2500 i 2600 W, napon: 220 Æ  
Namena: kafemat

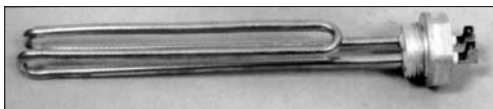

## GKM - 1250 na 1"

Snaga: 2000 W, napon: 220 Æ  
Namena: kafemat



## GB - 2000 - 3000

Snaga: 2000 i 3000 W, napon: 220 Æ  
Namena: Kon~ar, Dinamo



## GB - 2000 - 3000

Snaga: 2000 i 3000 W, napon: 220 Æ  
Namena: Dinamo, Leov

Servis i prodavnica:  
Bra}a Mingovi 18, Bitola  
(stara ~ar{ija)  
tel./faks: 097 / 30-633

Fabrika i prodavnica na golemo:  
Dame Gruev 177, Bitola  
(nas. mal pariz)  
tel./faks: 097 / 30-877

Zastapnik:



# ELEKTROLUKS

- FABRIKA ZA GREJAČE

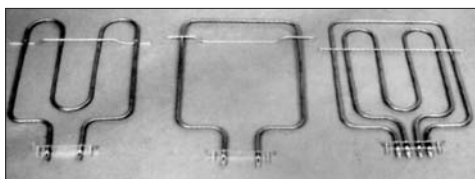

## G{ - 900 - 2900

Snaga: 900, 950, 1100 i 2900 W,  
napon: 220 V  
Namena: [poret Gorewe

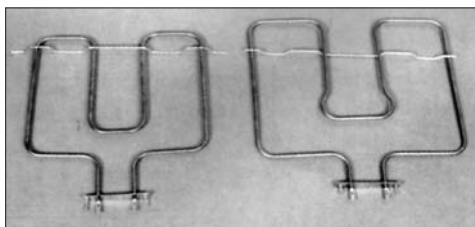

## G{ - 1150 - 1200

Snaga: 1150 i 1200 W,  
napon: 220 V  
Namena: [poret Gorewe

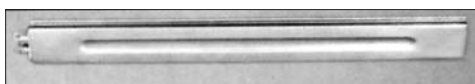

## G{K - 600

Snaga: 600 W, napon: 220 V  
Namena: [poret Gorewe

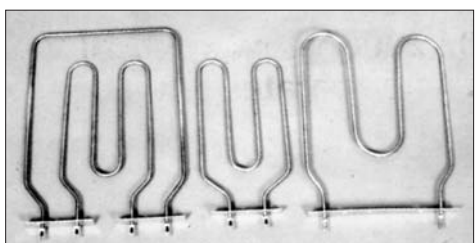

## G{ - 1200 - 2000

Snaga: 1200 i 2000 W, napon: 220 V  
Namena: [poret Iskra (Korona i Venera)

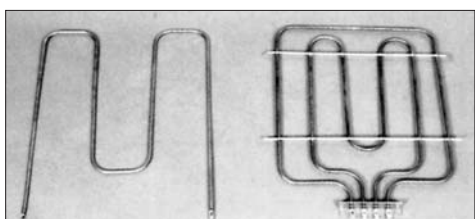

## G{ - 1440 - 2950

Snaga: 1440 i 2950 W, napon: 220 V  
Namena: [poret Artur Martin

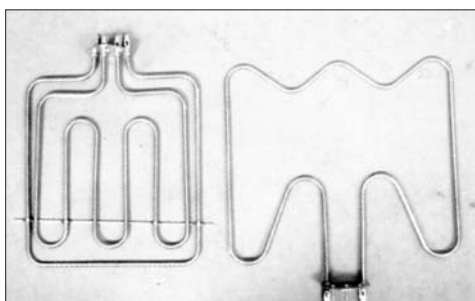

## G{ - 1550 - 2950

Snaga: 1550 i 2950 W, napon: 220 V  
Namena: [poret Kon~ar

Servis i prodavnica:  
Bra}a Mingovi 18, Bitola  
(stara ~ar{ija)

tel./faks: 097 / 30-633

Fabrika i prodavnica na golemo:

Dame Gruev 177, Bitola

(nas. mal pariz)

tel./faks: 097 / 30-877

Zastapnik:



# ELEKTROLUKS

- FABRIKA ZA GREJAČE

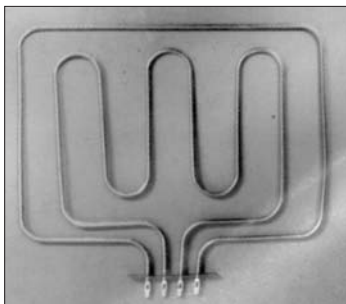

## G{ - 1000 - 1400

Snaga: 1000 i 1400 W,  
napon: 220 V  
Namena: [poret Deligrad

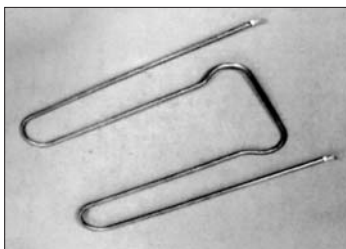

## G{ - 900

Snaga: 900 W, napon: 220 V  
Namena: [poret Smederevac

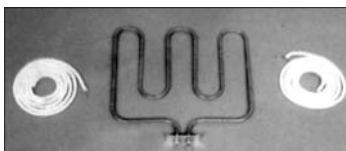

## G{ - 600 i monista

Snaga: 600 W, napon: 220 V ceven grejač  
400+500, 2h520 W, napon: 220 V monista  
Namena: [poret Sloboda ^a~ak

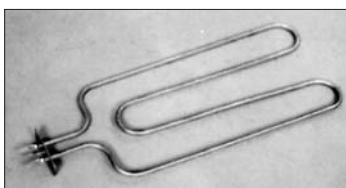

## GG - 1250

Snaga: 1250 W, napon: 220 V  
Namena: grejalica Preporod

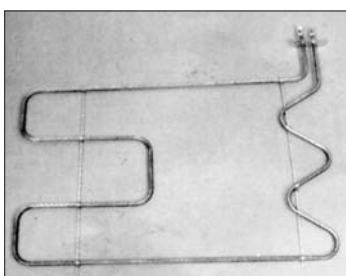

## GR - 2500

Snaga: 2500 W, napon: 220 V  
Namena: relni IGO

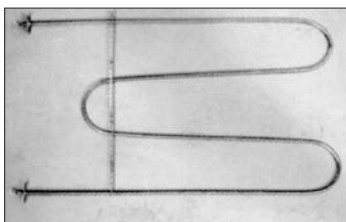

## GR - 1600 - 2300

Snaga: 1600 i 2300 W, napon: 220 V  
Namena: relni Kon~ar

Servis i prodavnica:  
Bra}a Mingovi 18, Bitola  
(stara ~ar{ija)  
tel./faks: 097 / 30-633

Fabrika i prodavnica na golemo:  
Dame Gruev 177, Bitola  
(nas. mal pariz)  
tel./faks: 097 / 30-877

Zastapnik:



# ELEKTROLUKS

- FABRIKA ZA GREANJE

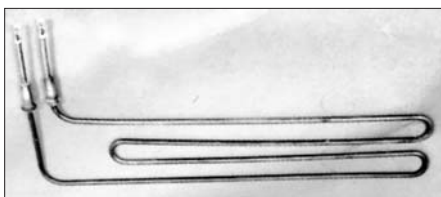

## GS - 2500

Snaga: 2500 W, napon: 220 V  
Namena: sušilnica

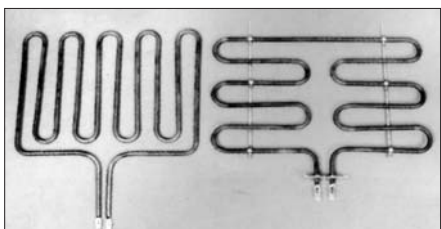

## GS - 1800 - 2000

Snaga: 1800, 2000 W, napon: 220 V  
Namena: skara

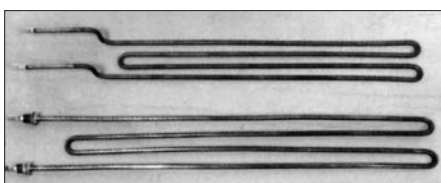

## GS - 1500

Snaga: 1500 W, napon: 220 V  
Namena: skara IGO

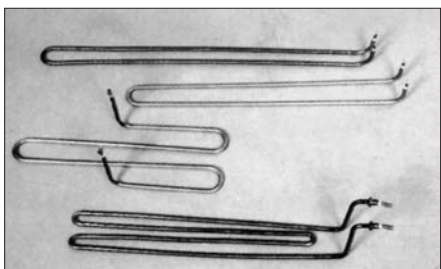

## GS - 700 - 1500

Snaga: 700, 1000, 1250, 1500 W,  
napon: 220 V  
Namena: skara



## GT - 800 - 1000

Snaga: 800, 900, 1000 W,  
napon: 110 i 220 V  
Namena: toster

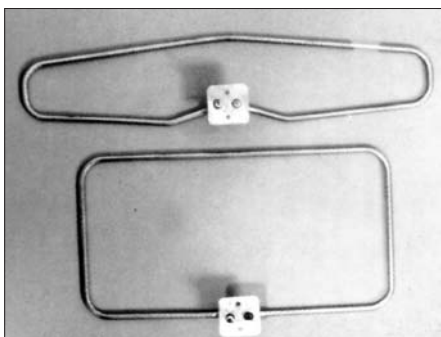

## GG - 1250 - 1600

Snaga: 1250 i 1600 W, napon: 220 V  
Namena: grealica MK i Konvektor

Servis i prodavnica:  
Bra}a Mingovi 18, Bitola  
(stara ~ar{ija)  
tel./faks: 097 / 30-633

Fabrika i prodavnica na golemo:  
Dame Gruev 177, Bitola  
(nas. mal pariz)  
tel./faks: 097 / 30-877

Zastapnik:



# ELEKTROLUKS

- FABRIKA ZA GREANJE I

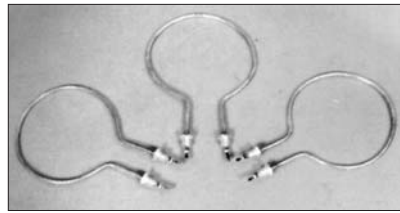
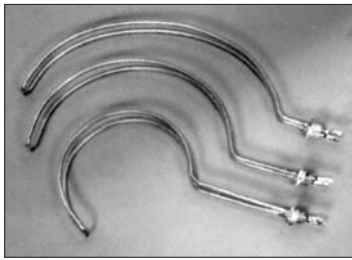

## DESTILATOR

Snaga: 3h2700, 3h1400 W,  
napon: 220 V  
Namena: destilator



## PATRON

Snaga: 50 do 1500 W,  
napon: 12, 24, .... do 220 V  
Namena: alati, skari, mašini ...

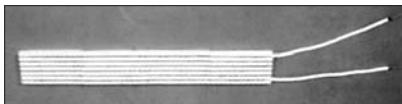

## na {AMOTNI PLOSKI

Snaga: 1000 do 4000 W,  
napon: 220 do 380 V  
Namena: furni, pr`ilnici za kafe ...

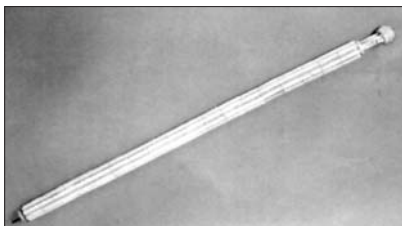

## vo {AMOTNI ZVEZDI

Snaga: 500, 1000 do 6000 W,  
napon: 220 do 380 V  
Namena: greewe na mazut, voda i dr.

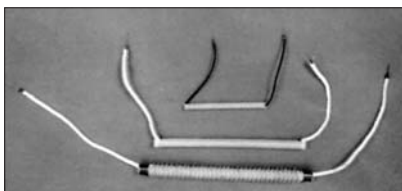

## na {AMOTNI {IPKI

Snaga: 600, 700 do 1250 W,  
napon: 220 V  
Namena: grealici i kaloriferi

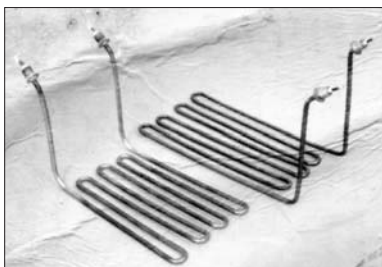

## FRITEZA

Snaga: 1000 do 2500 W,  
napon: 220 V  
Namena: friteza

Servis i prodavnica:  
Bra}a Mingovi 18, Bitola  
(stara ~ar{ija)  
tel./faks: 097 / 30-633  
Fabrika i prodavnica na golemo:  
Dame Gruev 177, Bitola  
(nas. mal pariz)  
tel./faks: 097 / 30-877

Zastapnik:



# ELEKTROLUKS

- FABRIKA ZA GREANJE I

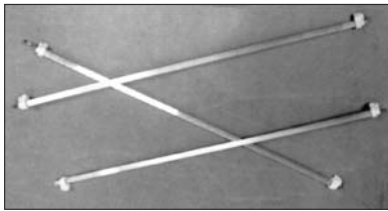

## KVARCEN

Snaga: 600 do 1200 W, napon: 220 V  
Namena: kvarcna grealica

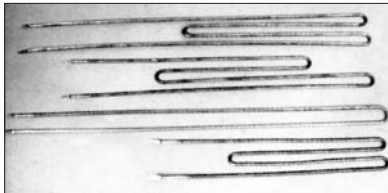

## GTA 1000 - 2000

Snaga: 1000, 1250, 1500, 1666 i 2000 W,  
napon: 220 V  
Namena: t. a. pe~ki CER ^a~ak



## GTA 660 - 2000

Snaga: 660, 833, 1000, 1166, 1333,  
1500, 1666 i 2000 W, napon: 220 V  
Namena: t. a. pe~ki MK Kraqevo

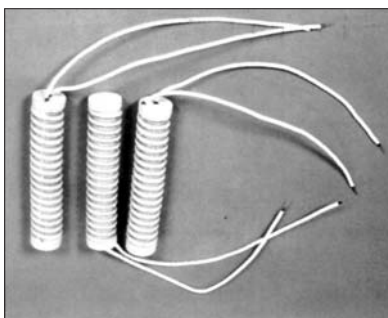

## GTA/KAL 833 - 1333

Snaga: 833, 1000, 1333 W, napon: 220 V  
Namena: t. a. pe~ka i kalorifer

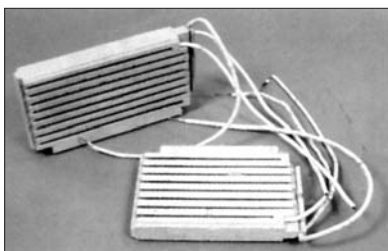

## ELIND - 1750 - 2250

Snaga: 1750 i 2250 W, napon: 220 V  
Namena: t. a. pe~ka ELIND Vqevo

Servis i prodavnica:  
Bra}a Mingovi 18, Bitola  
(stara ~ar{ija)  
tel./faks: 097 / 30-633  
Fabrika i prodavnica na golemo:  
Dame Gruev 177, Bitola  
(nas. mal pariz)  
tel./faks: 097 / 30-877

Zastapnik:



# ELEKTROLUKS

- FABRIKA ZA GREANJE

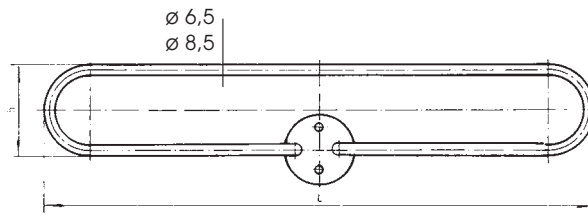

TIP	L	b	Watt	Volt
GKG/I	362	64	1000	220

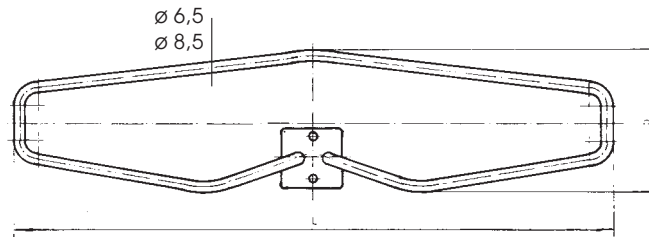

TIP	L	b	Watt	Volt
GKG/I	442	950	1250	220

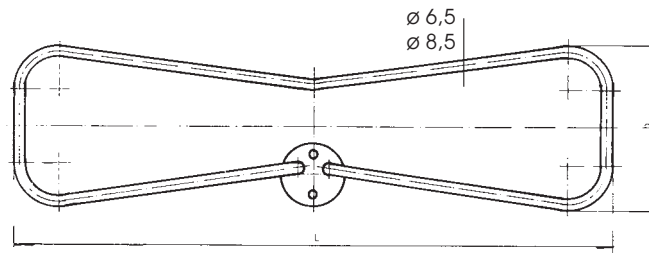

TIP	L	b	Watt	Volt
GKG/I	476,5	106,5	1500	220

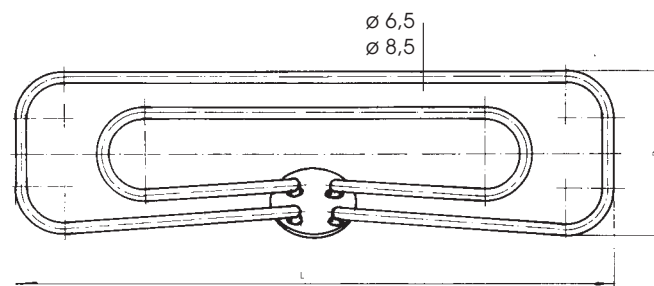

TIP	L	b	Watt	Volt
GKG/I	476	106,5	1200+800	220

Servis i prodavnica:  
Bra}a Mingovi 18, Bitola  
(stara ~ar{ija)

tel./faks: 097 / 30-633

Fabrika i prodavnica na golemo:

Dame Gruev 177, Bitola

(nas. mal pariz)

tel./faks: 097 / 30-877

Zastapnik:



# ELEKTROLUKS

- FABRIKA ZA GREANJE

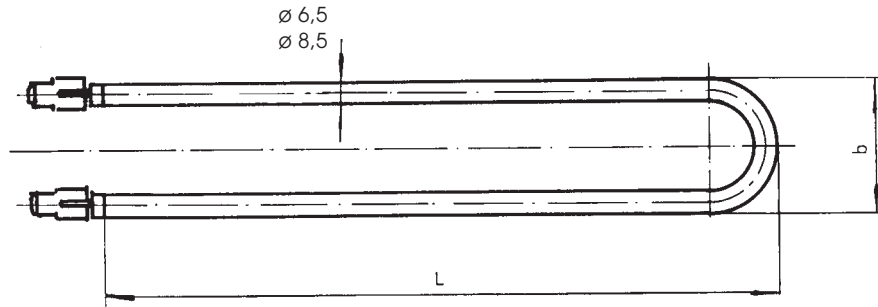

TIP	L	b	Watt	Volt	TIP	L	b	Watt	Volt
GTP/I	477	43	833	220	GTP/I	793	43	1125	220
GTP/I	906	43	833	220	GTP/I	693	43	1166	220
GTP/I	693	43	875	220	GTP/I	912	43	1333	220
GTP/I	693	43	1000	220	GTP/I	940	43	1500	220
GTP/I	906	43	1000	220	GTP/I	1129	43	2000	220

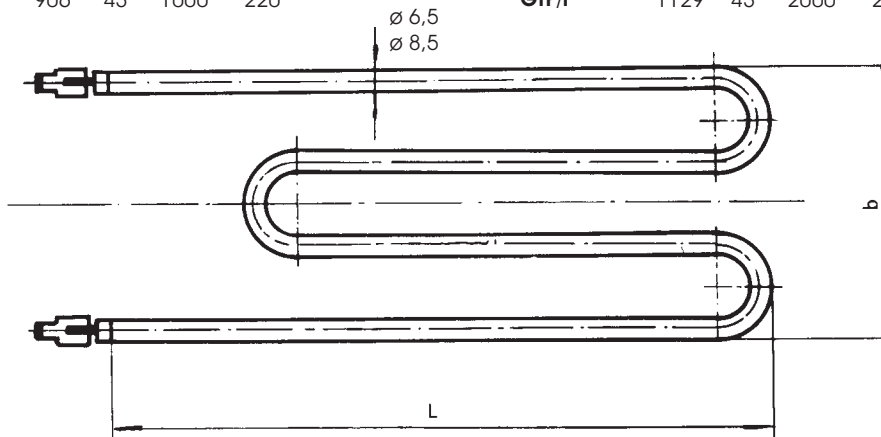

TIP	L	b	Watt	Volt
GTP/I	510	96	1125	220
GTP/I	760	120	1666	220
GTP/I	885	120	2000	220

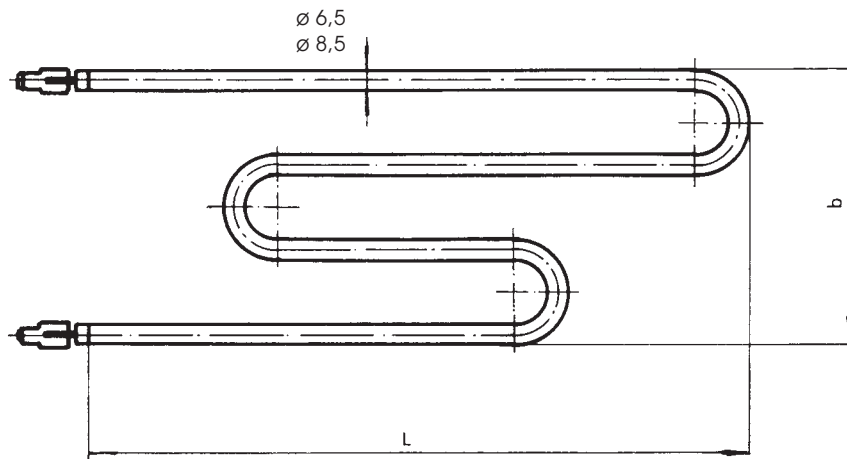

TIP	L	b	Watt	Volt
GTP/I	760	96	1500	220

Servis i prodavnica:  
 Bra}a Mingovi 18, Bitola  
 (stara ~ar{ija)  
 tel./faks: 097 / 30-633  
 Fabrika i prodavnica na golemo:  
 Dame Gruev 177, Bitola  
 (nas. mal pariz)  
 tel./faks: 097 / 30-877

Zastapnik:





# ELEKTROLUKS

- FABRIKA ZA GREANJE I

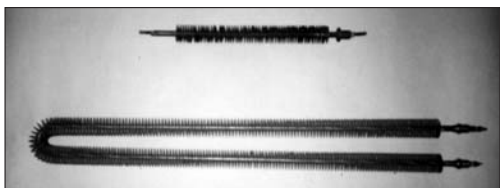

## GVS - 1000 - 3000

Snaga: 1000, 2000, 3000 W,  
napon: 24, 48, 110, 220, 380 V  
Namena: klimatizeri



## GK - 2000 - 2500

Snaga: 2000, 2500 W, napon: 220 V  
Namena: [poret Kerting (gorewe)]

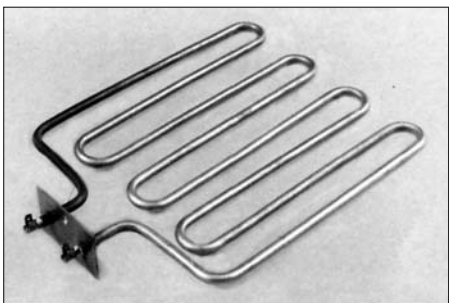

## GK - 1500 - 3000

Snaga: 1500, 2000, 3000 W,  
napon: 220, 380 V  
Namena: kaloriferi

Kon~ar, Klimaluks, Sokol

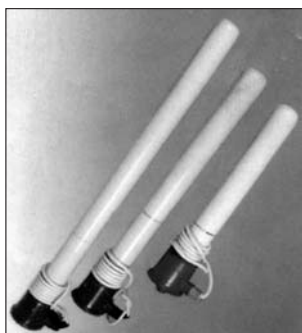

## GALVANSKI GREANJE I

### PG - 600 - 3000

Snaga: 600, 1000, 1500, 2000,  
3000 W, napon: 220, 380 V  
Materijal: prohrom, porcelan,  
staklo ili titan  
Namena: galvanski grean~e

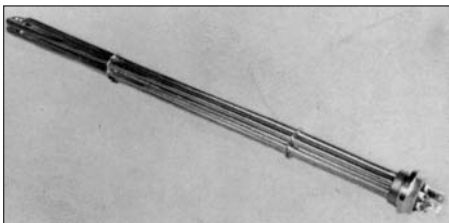

Servis i prodavnica:  
Bra}a Mingovi 18, Bitola  
(stara ~ar{ija)  
tel./faks: 097 / 30-633

Fabrika i prodavnica na golemo:  
Dame Gruev 177, Bitola  
(nas. mal pariz)  
tel./faks: 097 / 30-877

Zastapnik:



# ELEKTROLUKS INDUSTRIJA

- FABRIKA ZA GREANJE I

## Elektri~en grea~ - galvanski

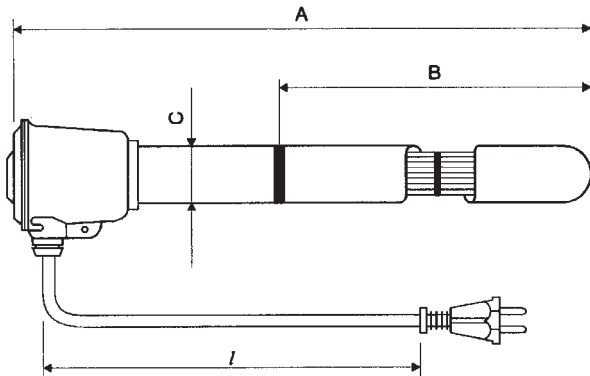

R. br.	S mm	A mm	V mm	/ m	U V	R kW	Za{. cevka
1	60	1000	800	1,5	220	3	porcelan
2	60	800	600	1,5	220	2	porcelan
3	60	600	450	1,5	220	1,5	porcelan
4	60	400	300	1,5	220	1	porcelan
5	50	1000	800	2	220	3	~ 4580
6	50	800	600	1,5	220	2	~ 4580
7	50	600	400	1,5	220	1	~ 4580

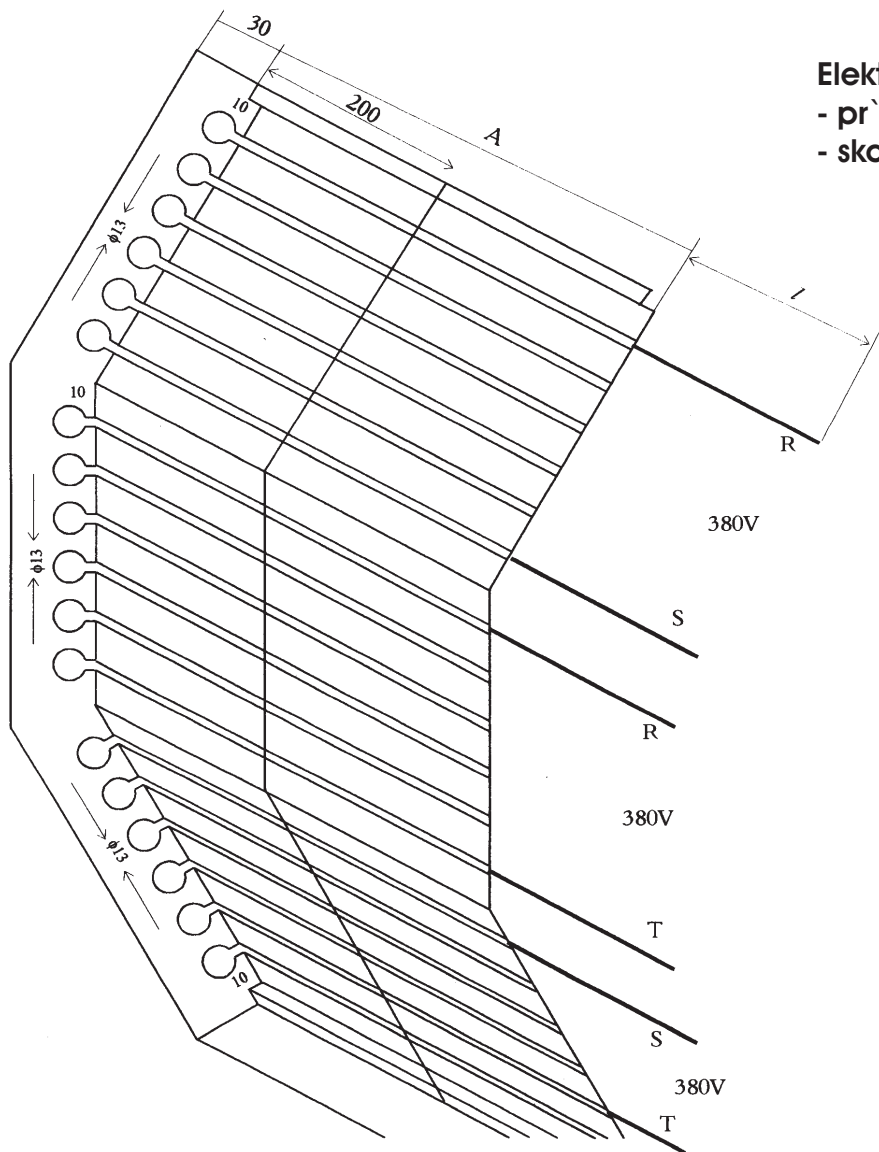

Elektri~en grea~ za  
- pr`ilnici za kafe  
- skari za giro i dr.

Servis i prodavnica:  
Bra}a Mingovi 18, Bitola  
(stara ~ar{ija)  
tel./faks: 097 / 30-633  
Fabrika i prodavnica na golemo:  
Dame Gruev 177, Bitola  
(nas. mal pariz)  
tel./faks: 097 / 30-877

Zastapnik:



# ELEKTROLUKS INDUSTRIJA

- FABRIKA ZA GREANJE

Vložki za električni grelnik

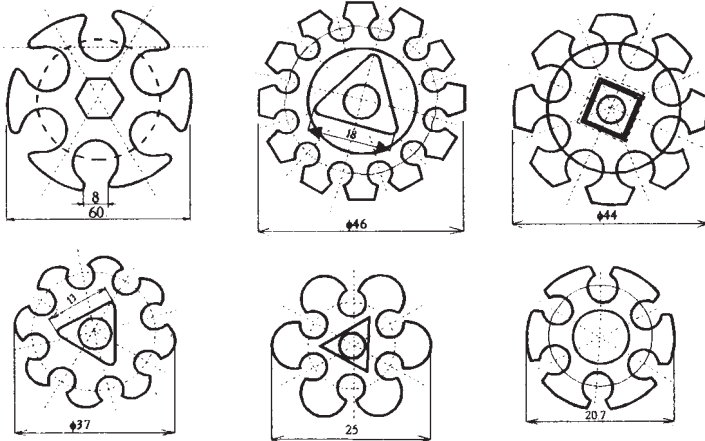

Ovие grelniki najgolema primena najdoa vo industriskite postrojki (galvaniziralka oprema, razni kadi i transveri za mиеve na delovi, razni peќki i su{ari, razni kotli za zagrevawe na voda, maslo, mazut i drugo. Voglavno se izrabotuvaa po naraќka.

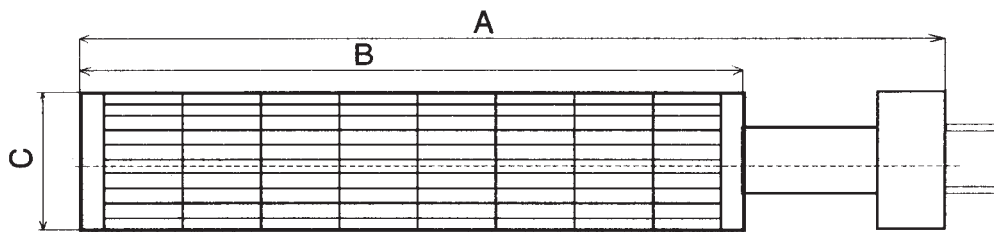

Električni grelnik na tehniќka keramika za vertikalno vgraduvawe, za TA peќki i lemiliќi.

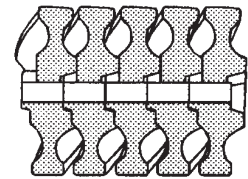
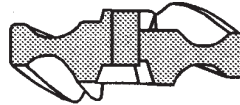

Elektriќen grelnik za vertikalno vgraduvawe. Najde primena vo galvanizaciskata oprema, za razni su{ari i kaloriferi, za topli zavesi i dr.

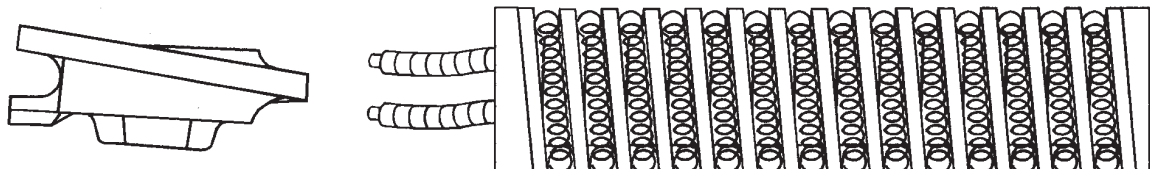

Elektriќen grelnik za TA peќki 220 V/833W, 220 V/1000W, 220 V/1333W. Najde primena i za kaloriferi.

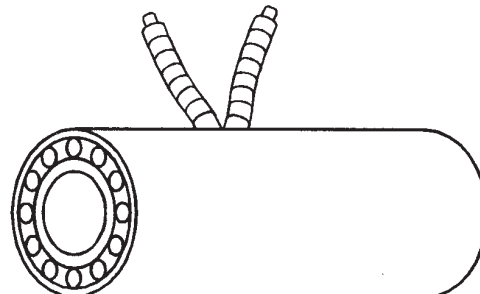
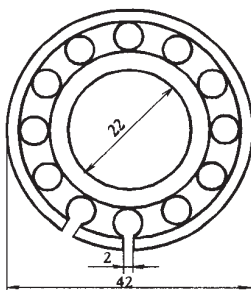

Elektriќen grelnik za lemiliќi za napon 220 V i snaga od 150 do 500W, po naraќka.

Servis i prodavnica:  
Braќa Mingovi 18, Bitola  
(stara naraќija)  
tel./faks: 097 / 30-633

Fabrika i prodavnica na golemo:  
Dame Gruev 177, Bitola  
(nas. mal pariz)  
tel./faks: 097 / 30-877

Zastapnik:



# ELEKTROLUKS INDUSTRIJA

- FABRIKA ZA GREANJE

Električni greači za kotli i bojleri

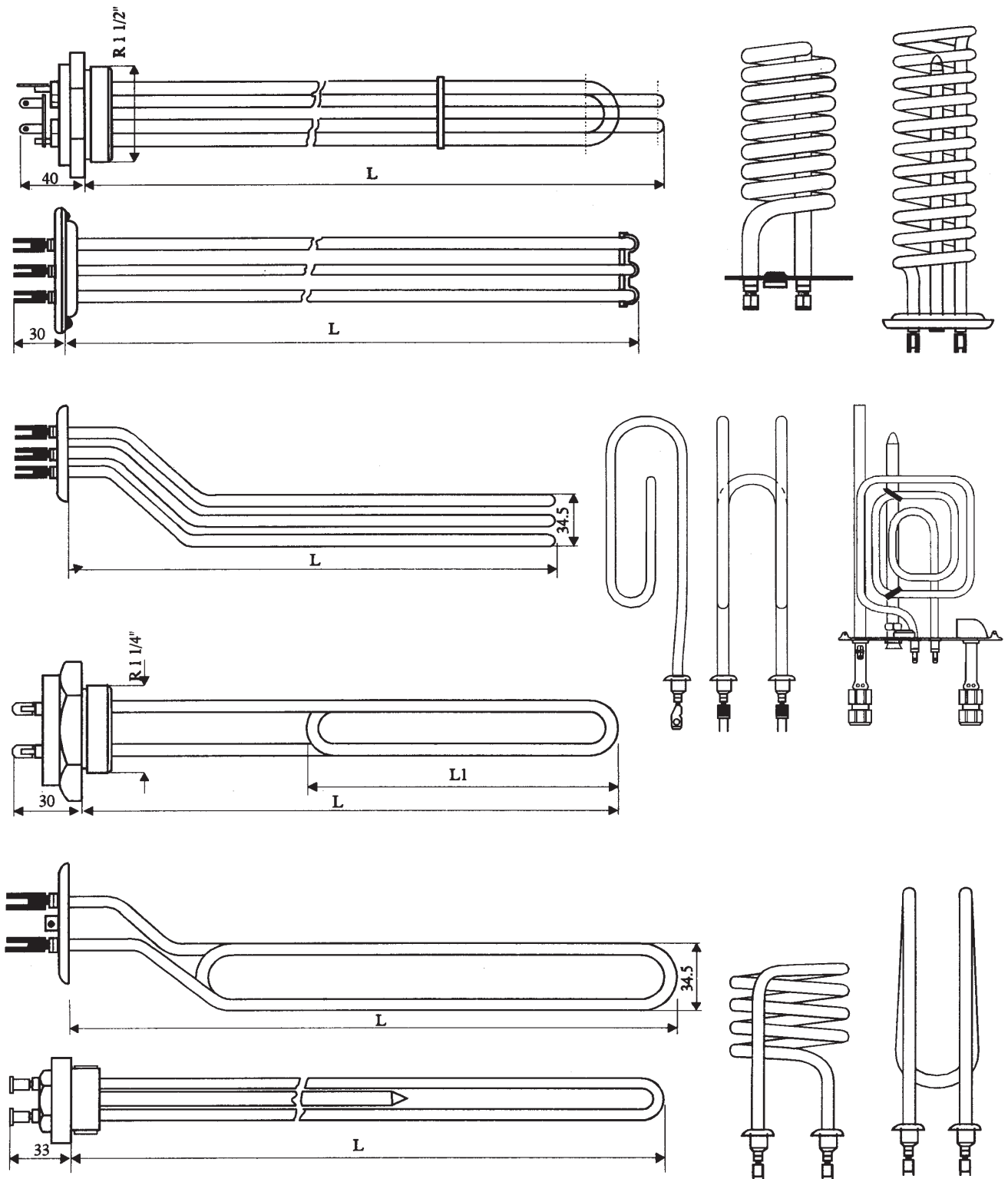

Servis i prodavnica:  
Braća Mingovi 18, Bitola  
(stara čaršija)  
tel./faks: 097 / 30-633

Fabrika i prodavnica na golemo:  
Dame Gruev 177, Bitola  
(nas. mal pariz)  
tel./faks: 097 / 30-877

Zastupnik:



# ELEKTROLUKS INDUSTRIJA

- FABRIKA ZA GREANJE

Elektri~en grea~ za prohromski bojleri

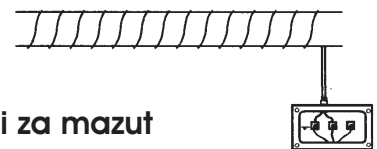
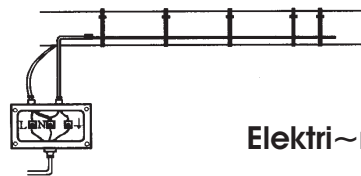
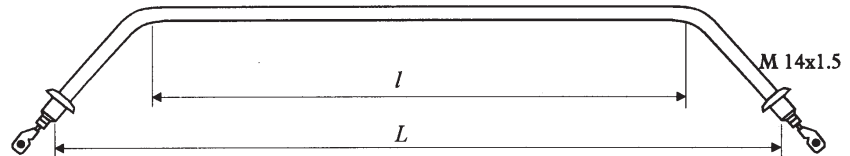
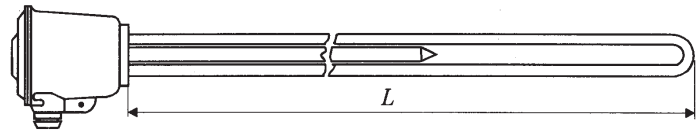
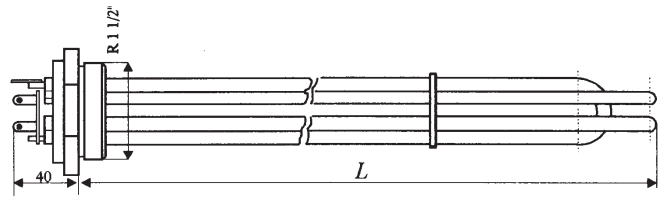
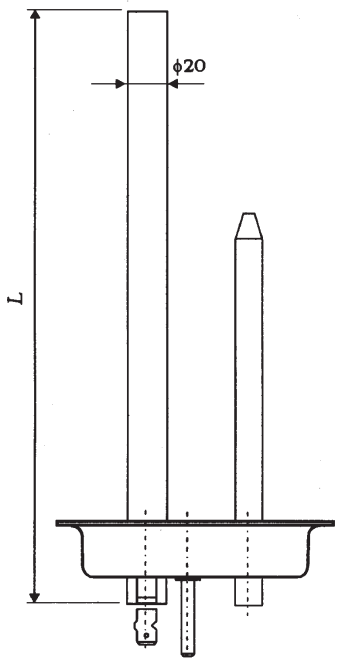

Elektri~ni grea~i za mazut

Elektri~ni grea~i za bela tehnika na "Gorewe"

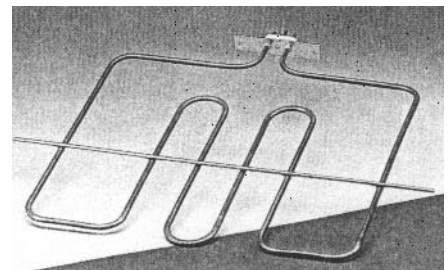
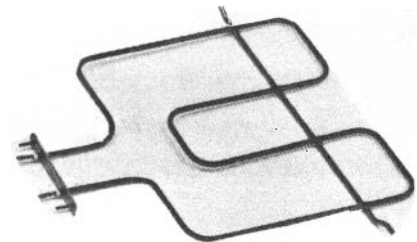
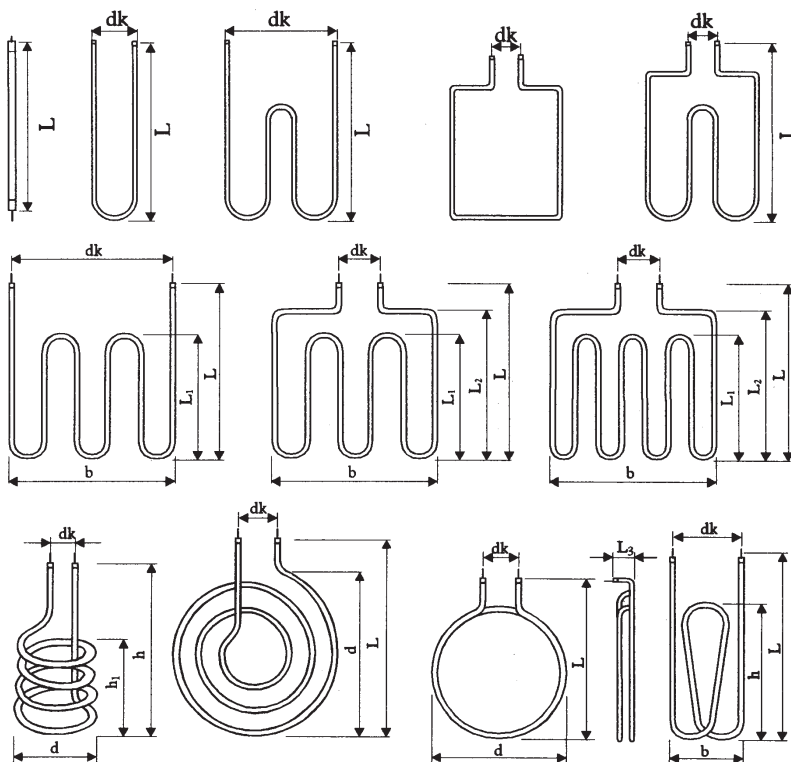

Elektri~ni grea~i za zagrevawe na vozduh

Ovie grea~i vglavno se izrabotuvaa po nara~ka.

Servis i prodavnica:  
Bra}a Mingovi 18, Bitola  
(stara ~ar{ija)  
tel./faks: 097 / 30-633

Fabrika i prodavnica na golemo:  
Dame Gruev 177, Bitola  
(nas. mal pariz)  
tel./faks: 097 / 30-877

Zastapnik:



# ELEKTROLUKS INDUSTRIJA

- FABRIKA ZA GREANJE

Elektri~ni greanji za bela tehnika

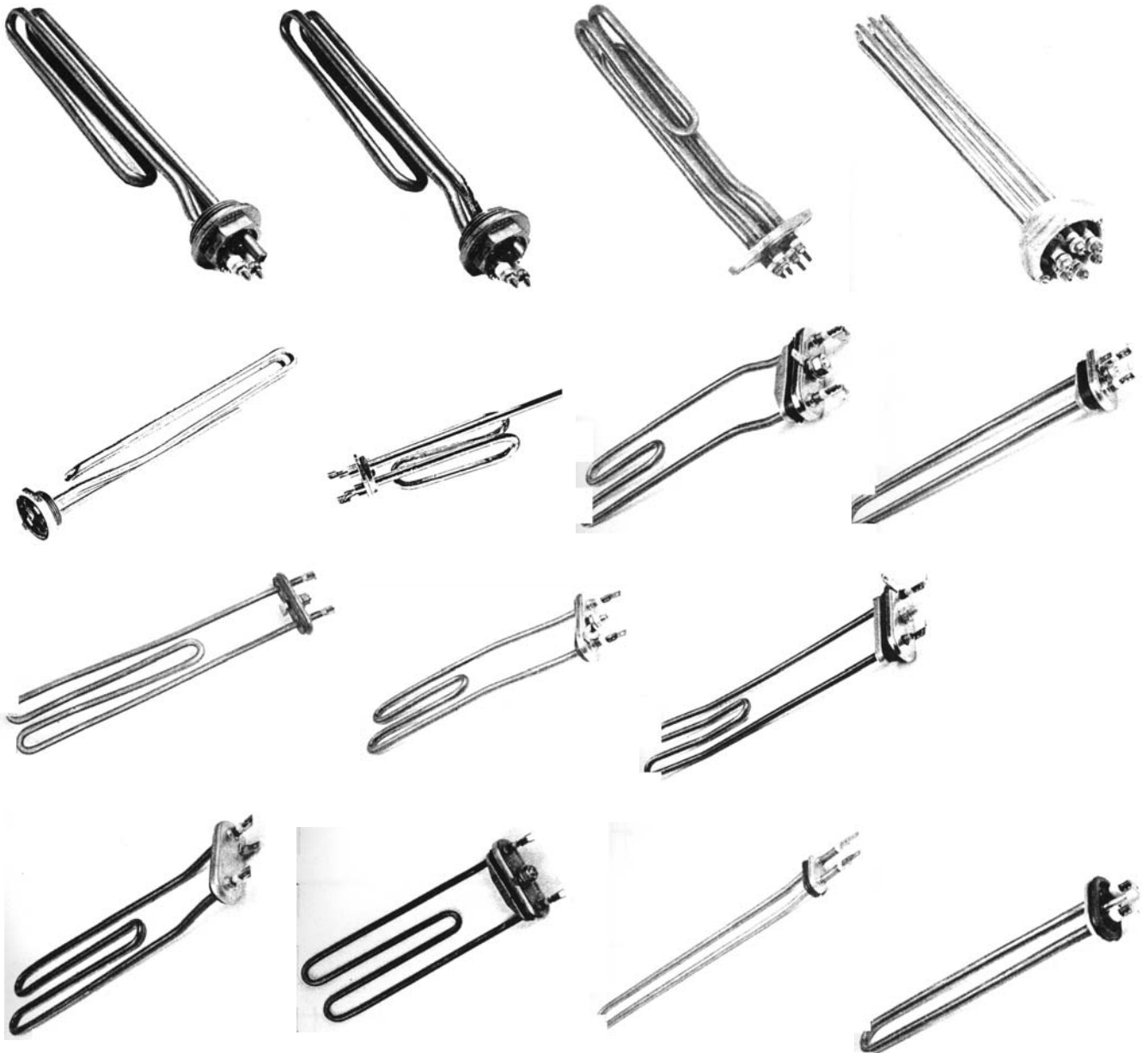

Servis i prodavnica:  
Bra}a Mingovi 18, Bitola  
(stara ~ar{ija)  
tel./faks: 097 / 30-633

Fabrika i prodavnica na golemo:  
Dame Gruev 177, Bitola  
(nas. mal pariz)  
tel./faks: 097 / 30-877

Zastapnik:



# ELEKTROLUKS INDUSTRIJA

- FABRIKA ZA GREANICE

Kvarcni greanice za bela tehnika i industrija

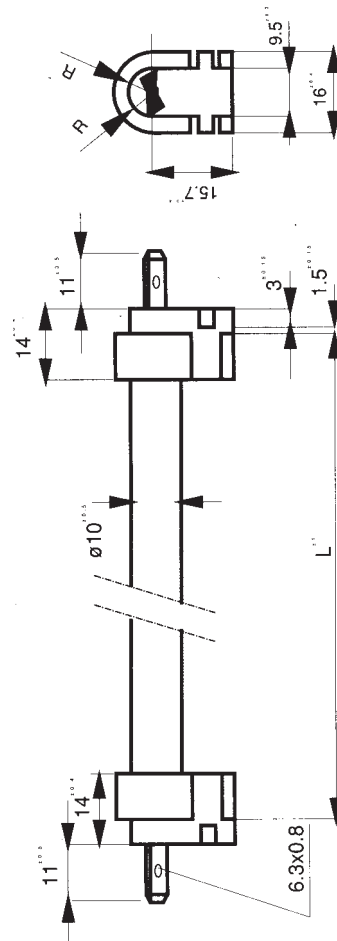
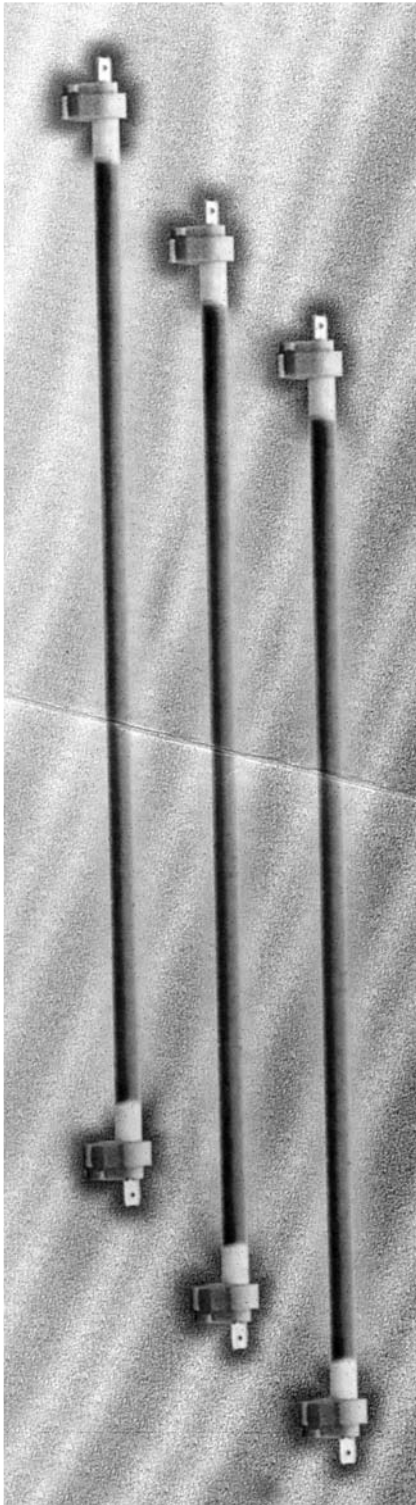

TIP	NAPON (V)	SNAGA (W)	DIM. CEVI (mm)
HKG	220	1000	615
HKG	220	1000	550
HKG	220	800	615
HKG	220	800	550
HKG	220	750	470
HKG	220	700	384
HKG	220	600	384
HKG	220	500	300
HKG	220	1200	750
HKG	220	1500	1170

Pri poro~ka na kvarcni greanice potrebno e da se navede: Napon, snaga i dimenzija.

Servis i prodavnica:  
Bra}a Mingovi 18, Bitola  
(stara ~ar{ija)

tel./faks: 097 / 30-633

Fabrika i prodavnica na golemo:

Dame Gruev 177, Bitola

(nas. mal pariz)

tel./faks: 097 / 30-877

Zastupnik:



# ELEKTROLUKS INDUSTRIJA

- FABRIKA ZA GREANJE

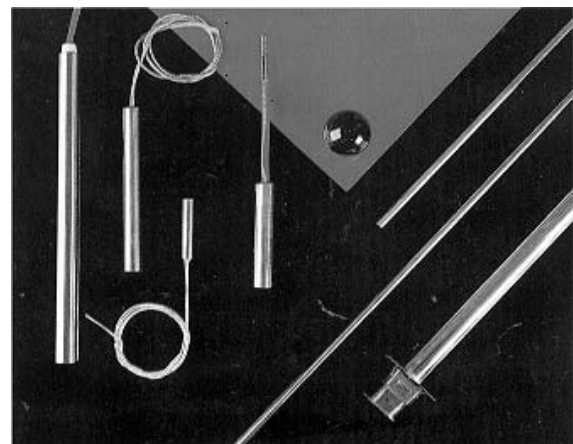
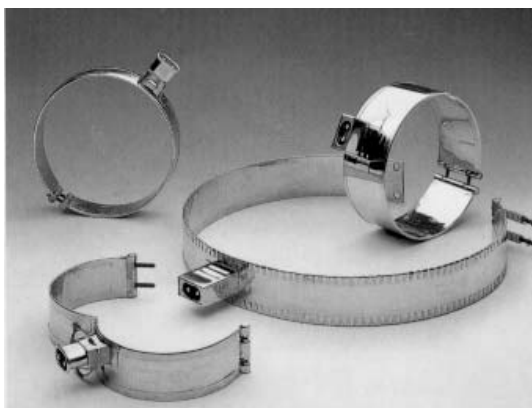
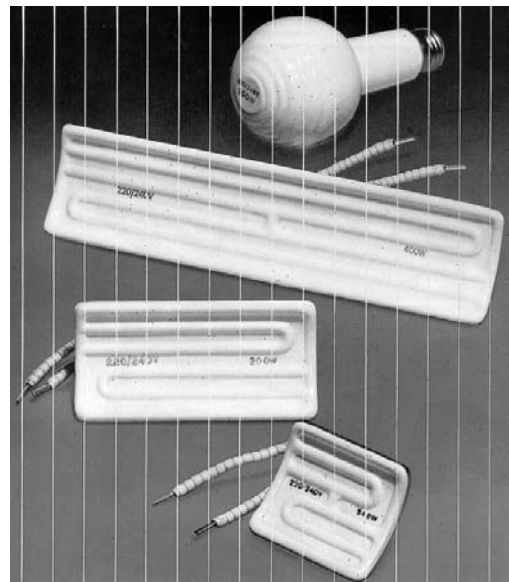

- 1 - 3. Plehni grea~i
4. Silikonski grea~i
5. Porcelanski grea~i
6. Patronski grea~i

Servis i prodavnica:  
Bra}a Mingovi 18, Bitola  
(stara ~ar{ija)  
tel./faks: 097 / 30-633

Fabrika i prodavnica na golemo:  
Dame Gruev 177, Bitola  
(nas. mal pariz)  
tel./faks: 097 / 30-877

Zastapnik:



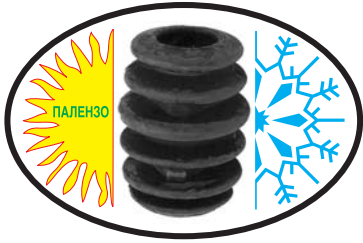

# ЕЛЕКТРОЛУКС

INDUSTRIJA ZA GREACI

ELEKTROLUKS

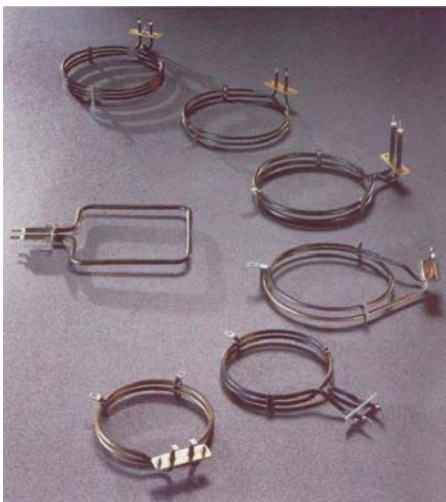
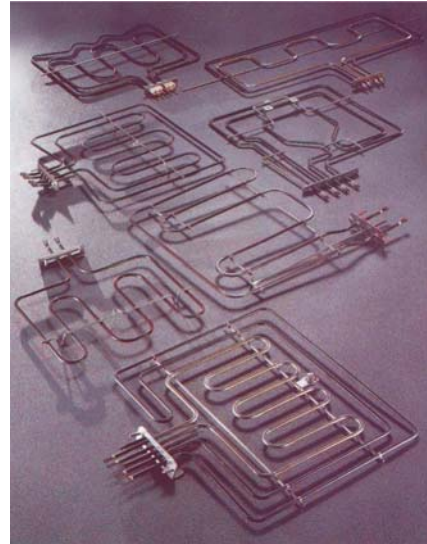

Adresa: ul.Braka Mingovi 18, 7000 Bitola; tel: 047 / 203-330; fax: 047 / 30-633; e-mail: [elek-palenzo@mt.net.mk](mailto:elek-palenzo@mt.net.mk)



# ELEKTROLUKS

INDUSTRIJA ZA GUMENI  
PROIZVODI

P - 1



ELEKTROLUKS

P - 2



ELEKTROLUKS

P - 3



ELEKTROLUKS

P - 4



ELEKTROLUKS

P - 5



ELEKTROLUKS



# ЕЛЕКТРОЛУКС

INDUSTRIJA ZA GUMENI  
PROIZVODI

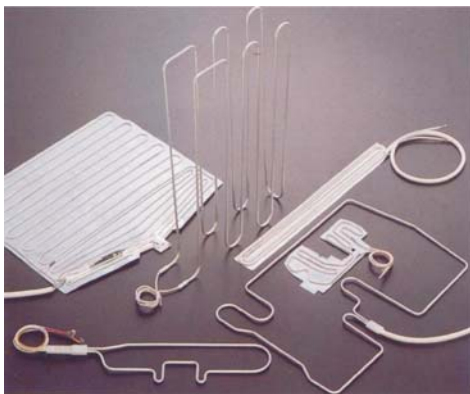

ELEKTROLUKS



# ELEKTROLUKS

INDUSTRIJA ZA GUMENI  
PROIZVODI

P - 1

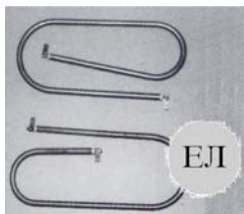

ELEKTROLUKS

P - 2

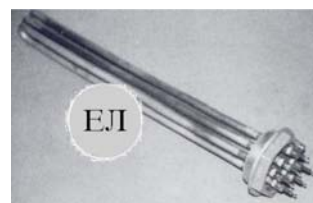

ELEKTROLUKS

P - 3



ELEKTROLUKS

P - 4

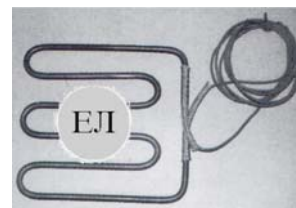

ELEKTROLUKS

P - 5



ELEKTROLUKS



# ELEKTROLUKS

INDUSTRIJA ZA GUMENI  
PROIZVODI

P - 1

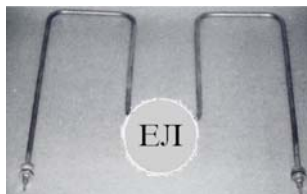

ELEKTROLUKS

P - 2



ELEKTROLUKS

P - 3



ELEKTROLUKS

P - 4



ELEKTROLUKS

P - 5

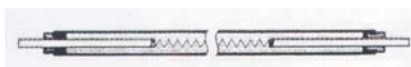

ELEKTROLUKS



# ELEKTROLUKS

INDUSTRIJA ZA GUMENI  
PROIZVODI

P - 1



ELEKTROLUKS

P - 2

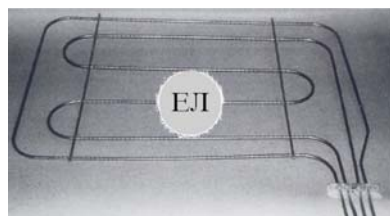

ELEKTROLUKS

P - 3

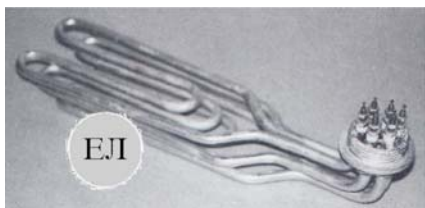

ELEKTROLUKS

P - 4

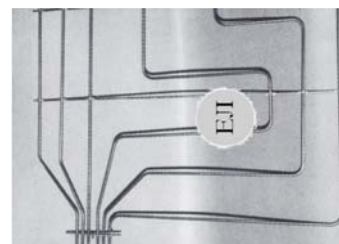

ELEKTROLUKS

P - 5

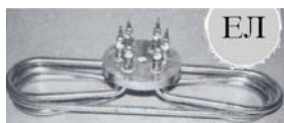

ELEKTROLUKS



# ELEKTROLUKS

INDUSTRIJA ZA GUMENI  
PROIZVODI

P - 1



ELEKTROLUKS

P - 2



ELEKTROLUKS

P - 3

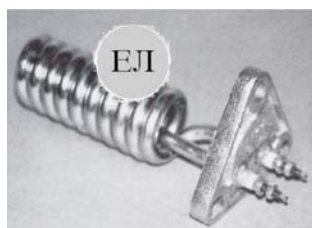

ELEKTROLUKS

P - 4

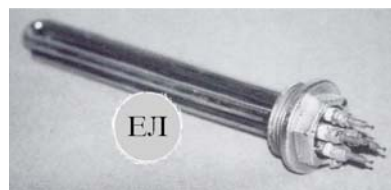

ELEKTROLUKS

P - 5



ELEKTROLUKS



# ELEKTROLUKS

INDUSTRIJA ZA GUMENI  
PROIZVODI

P - 1



ELEKTROLUKS

P - 2



ELEKTROLUKS

P - 3

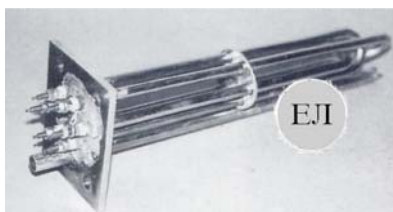

ELEKTROLUKS

P - 4



ELEKTROLUKS

P - 5

ELEKTROLUKS