

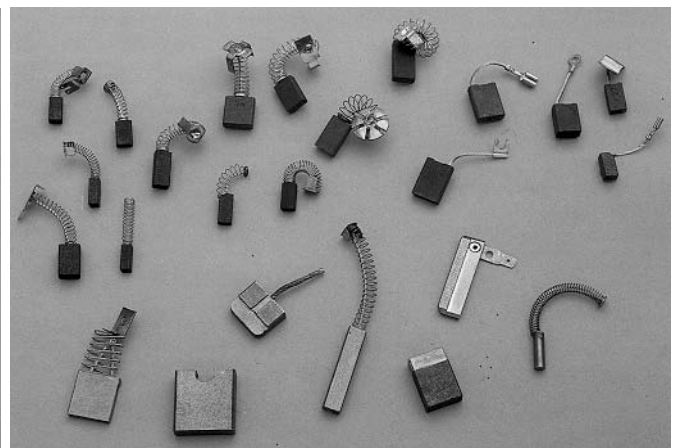

# ELEKTROLUKS - ELEKTROIMPORT

**Carbonex**

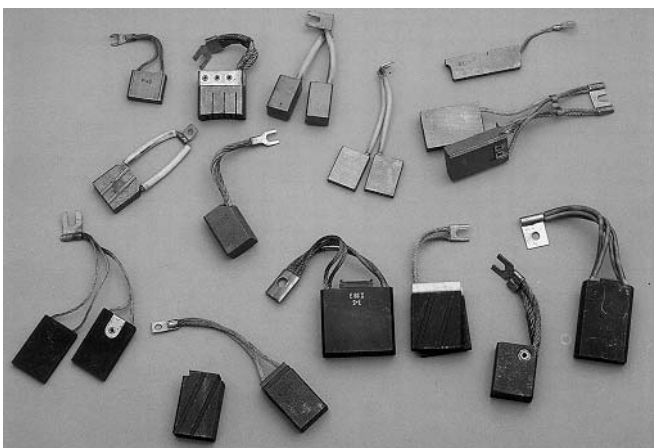
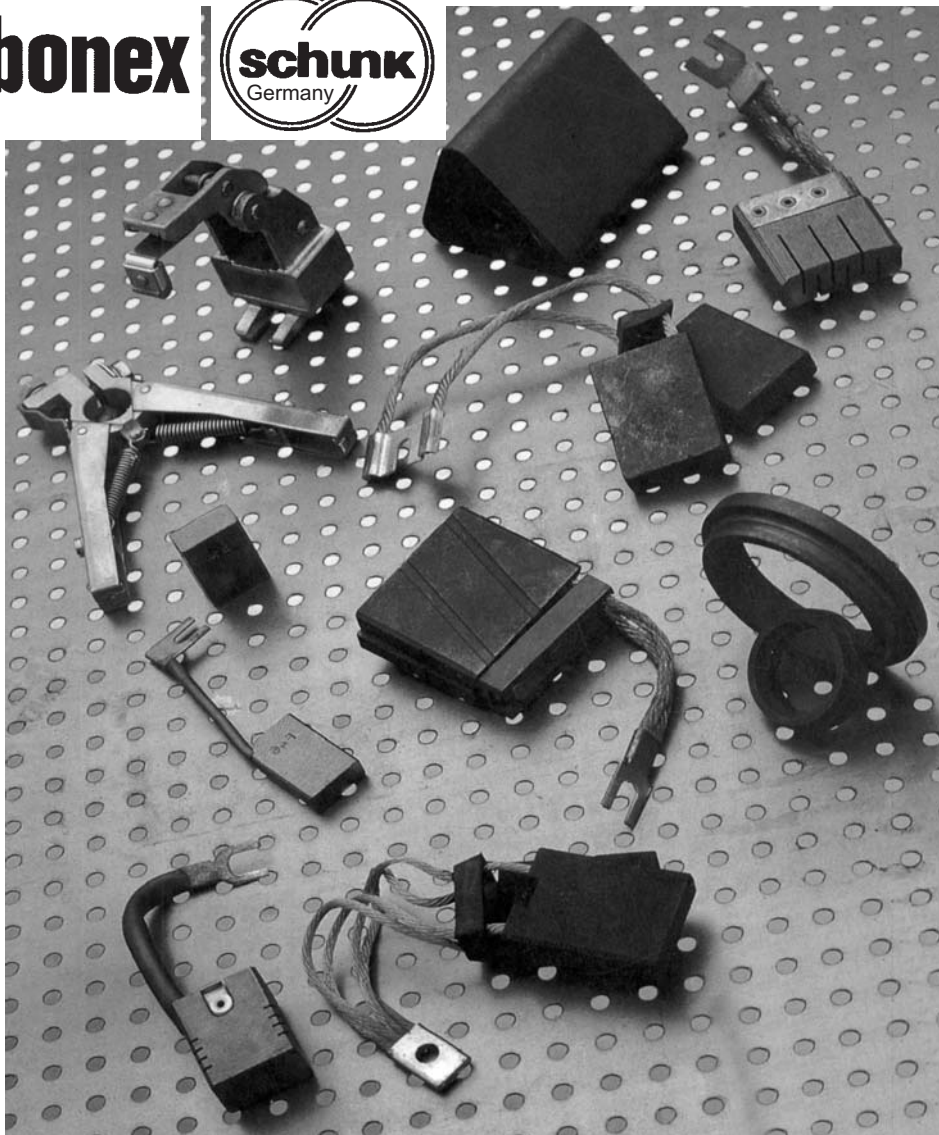

Servis i prodavnica:  
Braća Mingovi 18, Bitola  
(stara čaršija)  
tel./faks: 097 / 30-633, 227-913  
Fabrika i prodavnica na golemo:  
Dame Gruev 177, Bitola  
(nas. mal pariz)  
tel./faks: 097 / 30-877, 49-067

Zastapnik:



# ELEKTROLUKS - ELEKTROIMPORT

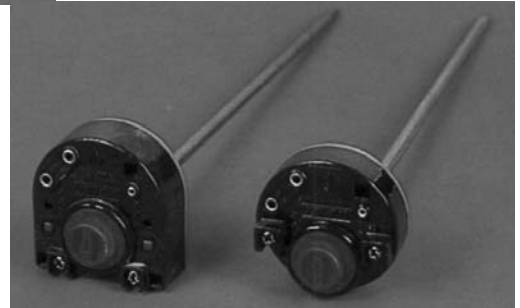
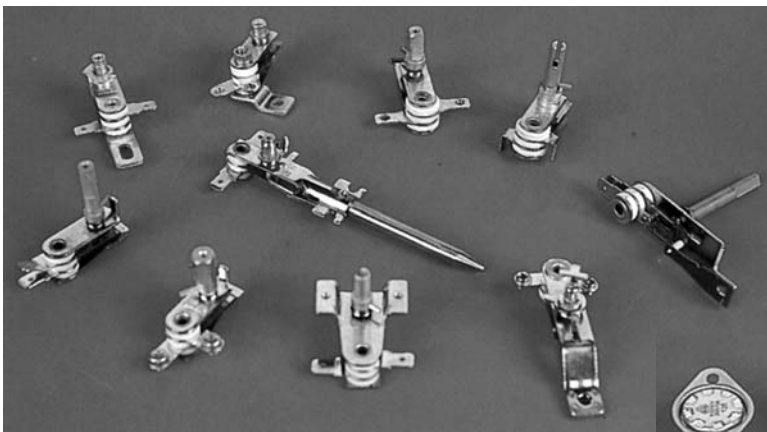
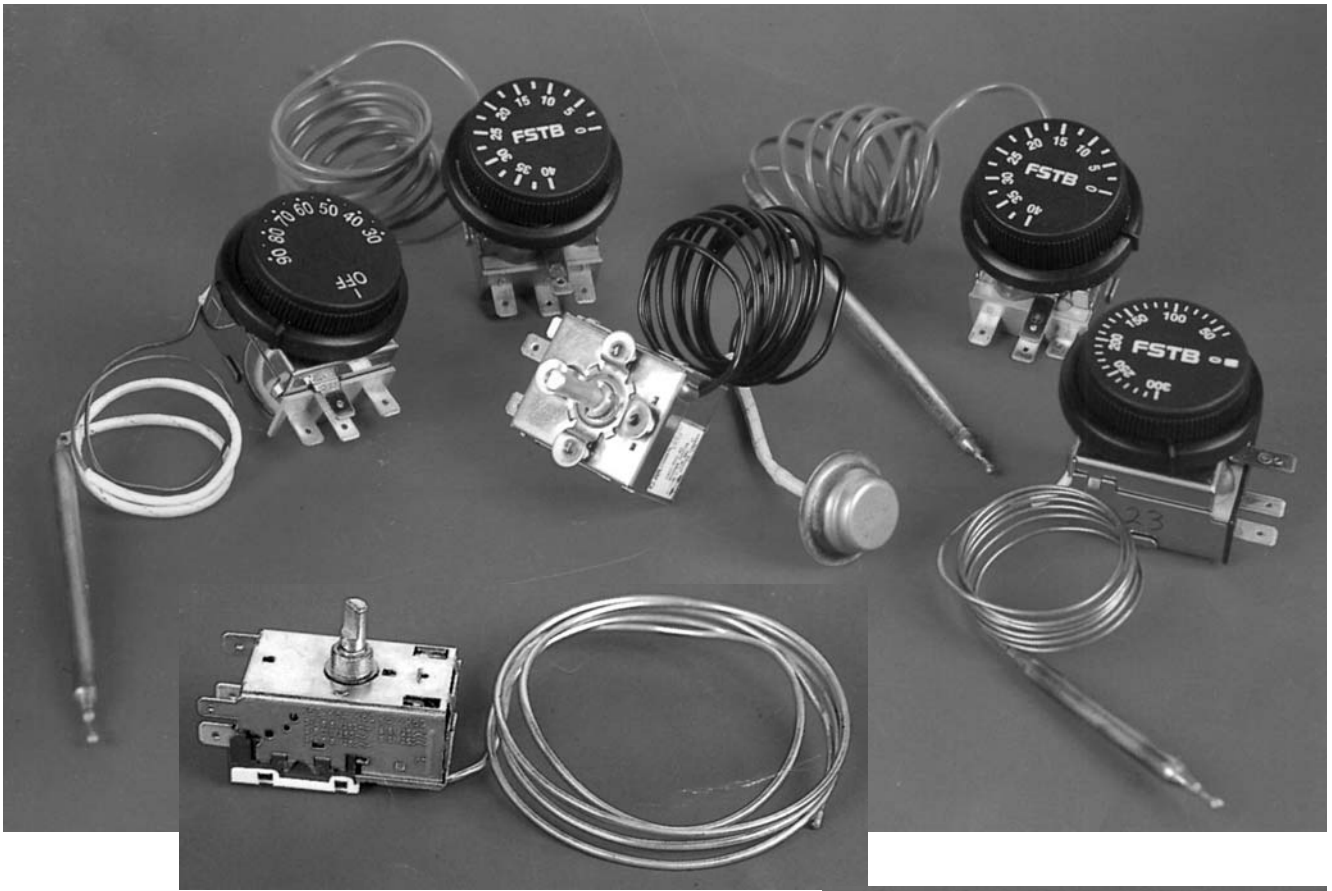

**FSTB**

**IMIT**

28053 CASTELLETTO TICINO (NO) - Italy

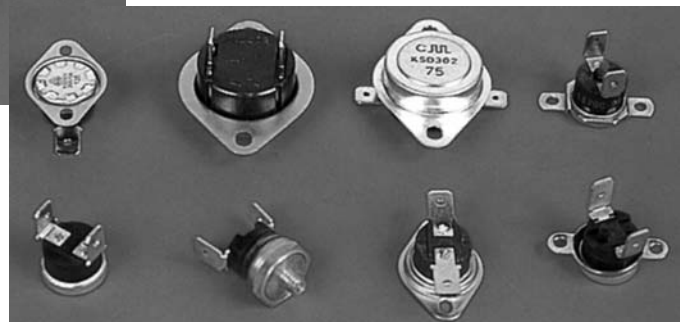

Servis i prodavnica:

Braća Mingovi 18, Bitola  
(stara čaršija)

tel./faks: 097 / 30-633, 227-913

Fabrika i prodavnica na golemo:

Dame Gruev 177, Bitola

(nas. mal pariz)

tel./faks: 097 / 30-877, 49-967

Zastupnik:



# ELEKTROLUKS

- ELEKTROIMPORT

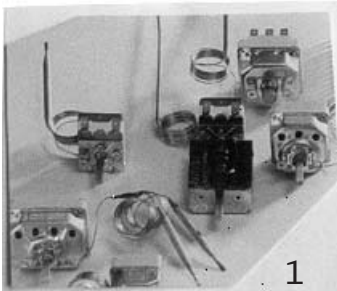

1

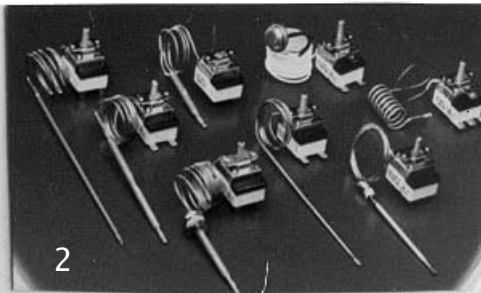

2

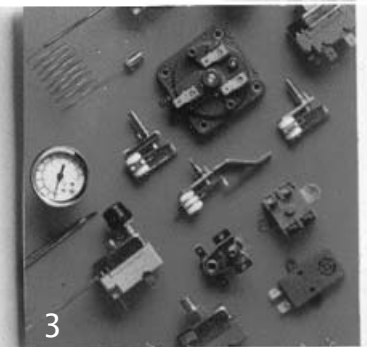

3

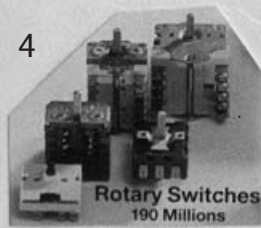

4

Rotary Switches  
190 Millions

c.a.e.m.  
s.r.l.



7

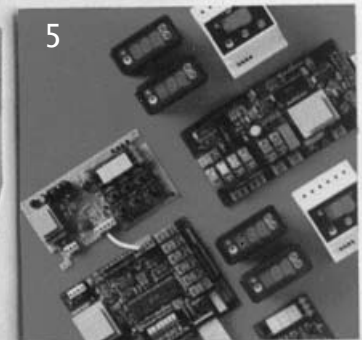

5

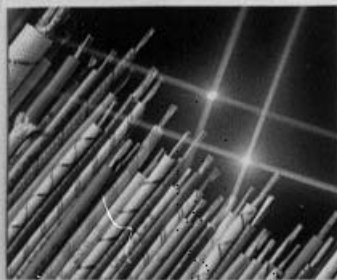

6



APPARECCHIATURE  
PER LA  
TERMOREGOLAZIONE  
CIVILE E INDUSTRIALE



8



9

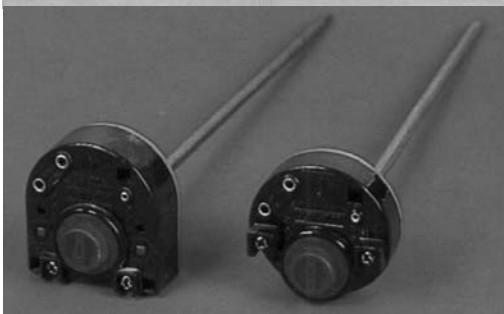

Servis i prodavnica:  
Braća Mingovi 18, Bitola  
(stara čaršija)  
tel./faks: 097 / 30-633, 227-913  
Fabrika i prodavnica na golemo:  
Dame Gruiev 177, Bitola  
(nas. mal pariz)  
tel./faks: 097 / 30-877, 49-067

Zastupnik:



# ELEKTROLUKS - ELEKTROIMPORT

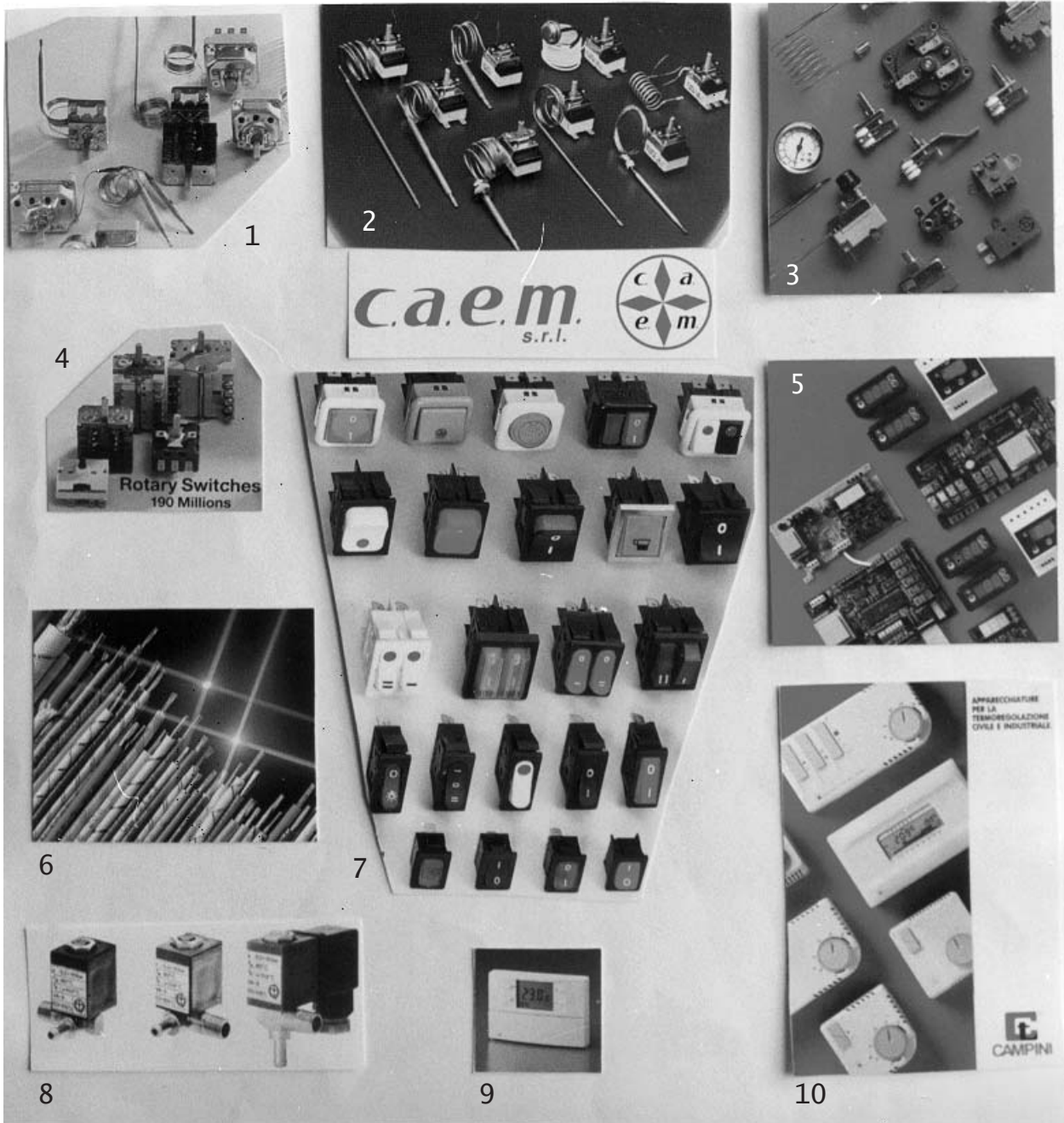

1. Termostati
2. Termostati
3. Termostati i termometri
4. Rotacioni prekinuvači
5. Elektronski termometri  
i termostati

6. Izolacioni cevki i silikonska žica
7. Prekinuvači (220, 24 i 12 V)
8. Elektromagnetni ventili
9. Elektronski programabilni termostati
10. Bimetalni i elektronski termostati

Servis i prodavnica:  
Braća Mingovi 18, Bitola  
(stara čaršija)

tel./faks: 097 / 30-633

Fabrika i prodavnica na golemo:

Dame Gruev 177, Bitola

(nas. mal pariz)

tel./faks: 097 / 30-877

Zastapnik:



# ELEKTROLUKS - ELEKTROIMPORT

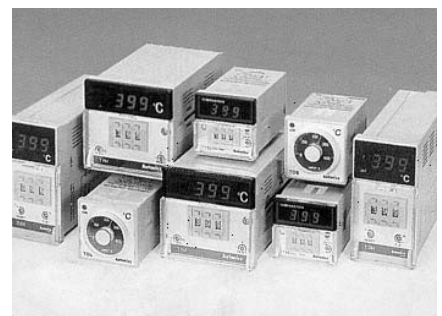
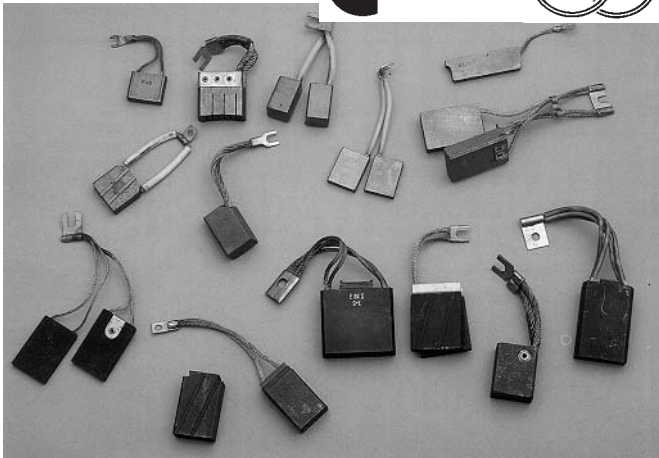
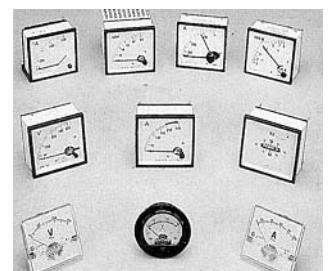
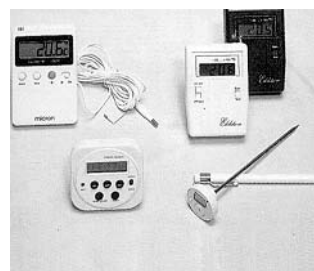
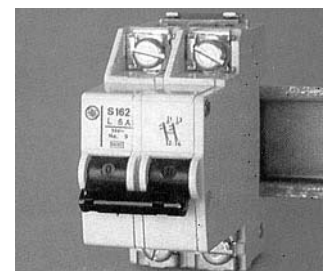
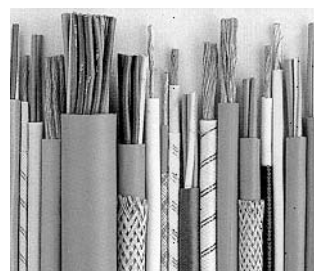
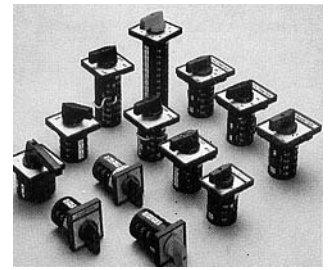
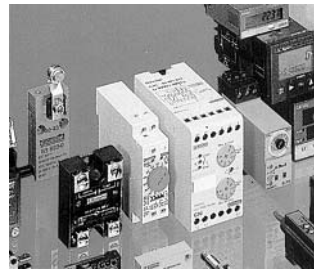
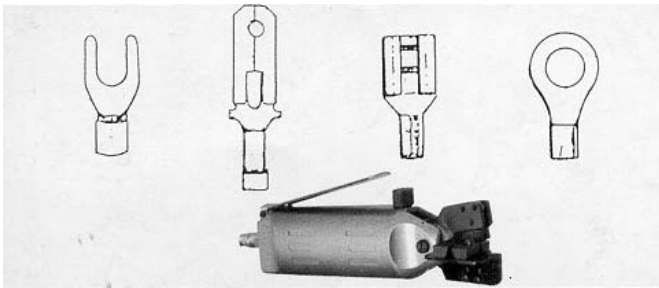
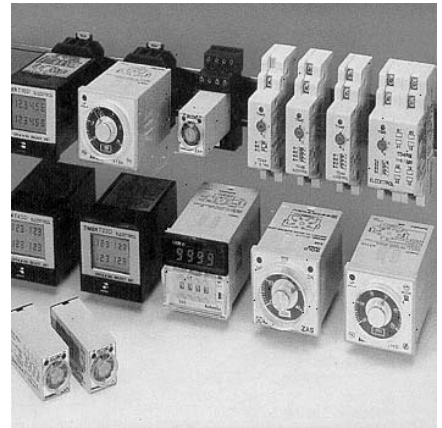
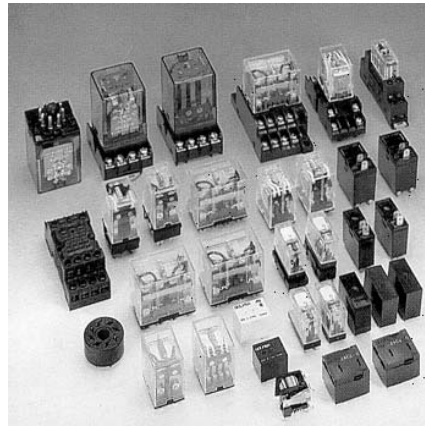
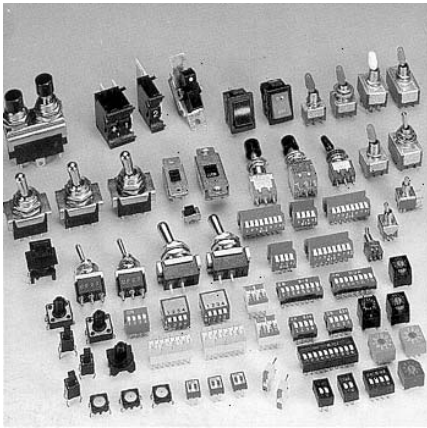

Servis i prodavnica:  
Braća Mingovi 18, Bitola  
(stara čaršija)  
tel./faks: 097 / 30-633, 227-913  
Fabrika i prodavnica na golemo:  
Dame Gruev 177, Bitola  
(nas. mal pariz)  
tel./faks: 097 / 30-877, 49-067

Zastapnik:



# ELEKTROLUKS - ELEKTROIMPORT

## GoldStar



Тип	KW	A	V	C - P	Цена
CH-3.1A	4	9	240	1 -	
CH-3.1B	4	9	240	- 1	
CH-3N.1A1B	4	9	240	1+1	
CH-5.1A1B	11	22	240	1+1	
CH-6.N2A2B	15	30	240	2+2	
CH-7.5N2A2B	18.5	37	240	2+2	
CH-10N2A2B	22	48	240	2+2	
CH-15N2A2B	30	65	240	2+2	
CH-20NS2A2B	40	80	240	2+2	
CH-25NS2A2B	55	105	240	2+2	
CH-30NS2A2B	60	120	240	2+2	
CH-4ANS2A2B	75	150	240	2+2	
CH-50NS2A2B	90	180	240	2+2	
CH-75NS2A2B	110	220	240	2+2	
CH-90NS2A2B	132	265	240	2+2	
CH-100NS2A2B	220	408	240	2+2	
CH-150NS2A2B	315	600	240	2+2	

Работен напон: 26V, 48V, 110V, 240V, 380V, 420V

Servis i prodavnica:  
Braća Mingovi 18, Bitola  
(stara čaršija)

tel./faks: 097 / 30-633

Fabrika i prodavnica na golemo:

Dame Gruev 177, Bitola

(nas. mal pariz)

tel./faks: 097 / 30-877

Zastapnik:



# ELEKTROLUKS

- ELEKTROIMPORT

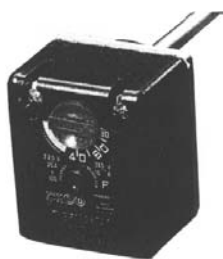

TEMOSTAT ZA BOJLER

Šifra:                      cena:



TEMOSTAT ZA BOJLER

vertikalen  
horizontalen

kratok  
Šifra:                      cena:

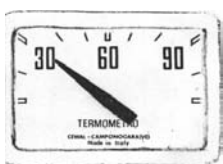

TEMOMETAR ZA BOJLER  
THERMOWATT

NO NAME  
[ifra:                      cena:

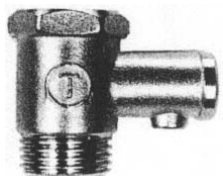

SIGURNOSEN VENTIL  
ZA BOJLER

Šifra:                      cena:

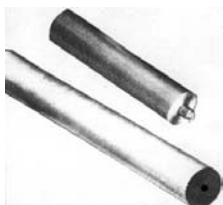

MAGNEZIUMSKA ANODA  
ZA BOJLER  
Ø 22 X 50, 100, 150, 200, 300  
Ø 26 H 350, 450  
Ø 32 H 500

[ifra:                      cena:



TERMOSTATI ZA MAŠINI  
ZA DOMAKINSTVO

Caem: 30 - 90°C, 16A  
Ø 10, Ø31

Caem: 41 - 90°C

Šifra:                      cena:

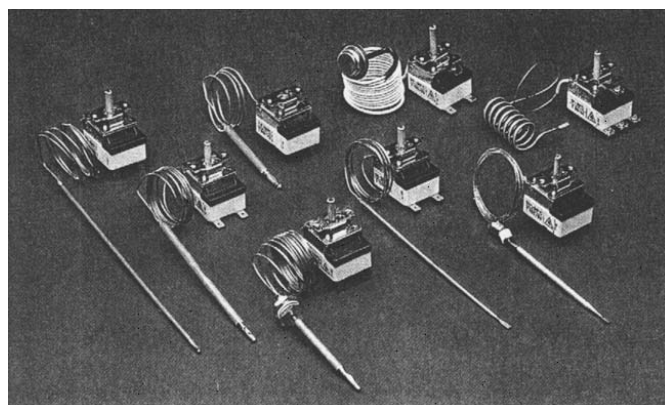
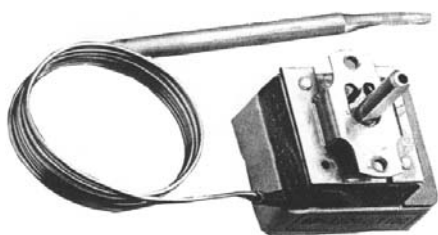

KAPILAREN TEMOSTAT - Saem

- 35 -	35°C	SP-DT
0 -	40°C	16A / III
0 -	40°C	Spiral
10 -	90°C	16A / II
10 -	90°C	16A / III
30 -	150°C	16A / III
50 -	200°C	16A Nickel
50 -	300°C	16A / II
50 -	300°C	16A / III
60 -	400°C	16A / III

[ifra:                      cena:



SIGURNOSNI TERMOSTATI  
Caem: 105°C, 210°C, 315°C  
Campini: 105°C

Šifra:                      cena:



DUGMINA  
PONIKLUVANA ROZETA

Šifra:                      cena:

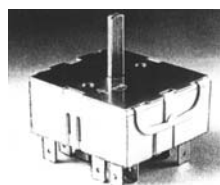

TERMOSTAT REGULATOR  
NA ENERGIJA

Šifra:                      cena:

Servis i prodavnica:  
Braća Mingovi 18, Bitola  
(stara čaršija)  
tel./faks: 097 / 30-633

Fabrika i prodavnica na golemo:  
Dame Gruiev 177, Bitola  
(nas. mal pariz)  
tel./faks: 097 / 30-877

Zastapnik:



# ELEKTROLUKS - ELEKTROIMPORT



ELEKTROVENTIL  
1/8, 0-15 bar  
150°C

Šifra:  
cena:



ELEKTROVENTIL ZA VODA  
1/8, 0-10 bar  
90°C

Šifra:  
cena:

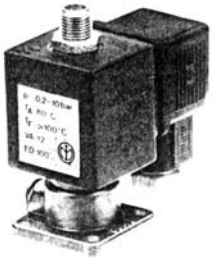

ELEKTROVENTIL  
6.912

Šifra:  
cena:



ELEKTROPUMPA  
ET 200

Šifra:  
cena:



ŠPULNA

Šifra:  
cena:

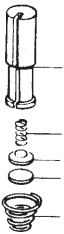

METALNA ZAPTIVKA

Šifra:  
cena:

Servis i prodavnica:  
Braća Mingovi 18, Bitola  
(stara čaršija)

tel./faks: 097 / 30-633

Fabrika i prodavnica na golemo:

Dame Gruiev 177, Bitola

(nas. mal pariz)

tel./faks: 097 / 30-877

Zastapnik:





# ELEKTROLUKS - ELEKTROIMPORT

## INDIKATORI

ZELEN, CRVEN, PORTOKALOV

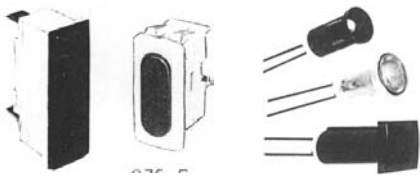

[ifra:  
cena:

[ifra:  
cena:

## KONEKTORI

MA[KI

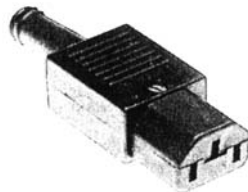

[ifra:  
cena:

@ENSKI

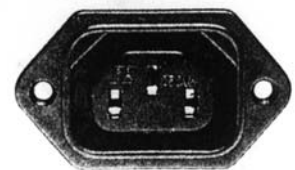

[ifra:  
cena:

## PREKINUVA^I

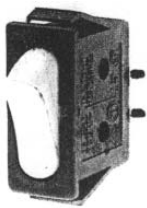

[ifra:  
cena:

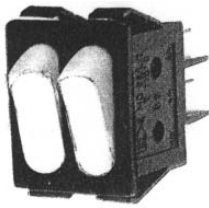

[ifra:  
cena:

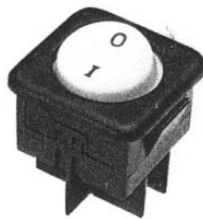

[ifra:  
cena:

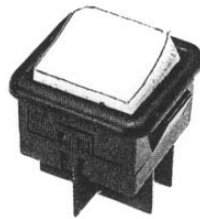

[ifra:  
cena:

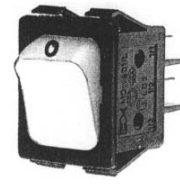

[ifra:  
cena:

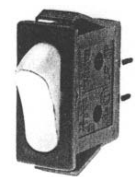

[ifra:  
cena:

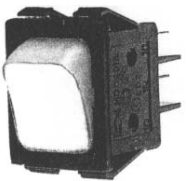

[ifra:  
cena:



[ifra:  
cena:



[ifra:  
cena:

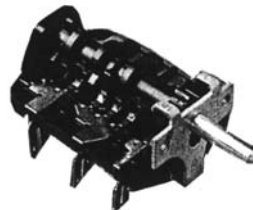

BAKELITEN  
PREKINUVA^I  
5-3, 3-2, 50-50

[ifra:  
cena:

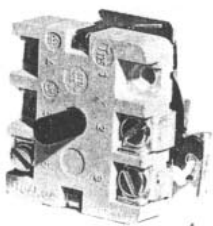

ROTACIONEN PREKINUVA^I  
16A

[ifra:  
cena:

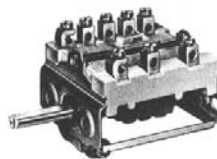

KERAMI^KI PREKINUVA^I  
ZA RELNA: 50-50, 5-3  
ZA RINGLA: 5-3, 4-3, 3-2, 4-2

[ifra:  
cena:

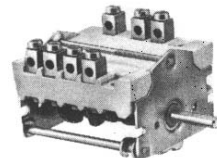

BAKELITEN PREKINUVA^I  
ZA RELNA: 50-50, 5-3  
ZA RINGLA: 5-3, 3-2

[ifra:  
cena:

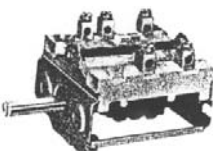

ROTACIONEN PREKINUVA^I  
3 - 2

[ifra:  
cena:



KERAMI^KI PREKINUVA^I  
32A, 3-2  
32A, 4-3

[ifra:  
cena:

Servis i prodavnica:  
Bra}a Mingovi 18, Bitola  
(stara ~ar{ija)  
tel./faks: 097 / 30-633  
Fabrika i prodavnica na golemo:  
Dame Gruev 177, Bitola  
(nas. mal pariz)  
tel./faks: 097 / 30-877

Zastapnik:



# ELEKTROLUKS - ELEKTROIMPORT

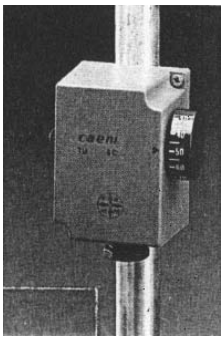

KONTAKT TEMOSTAT - Saem  
(HYDROSTATIC)

[ifra:           cena:



KAPILAREN TEMOSTATI - TERMOMETRI

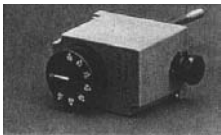

NAZIVEN TEMOSTAT - Saem  
EDINEAEN

[ifra:           cena:

- 45 - 35°C  
45 - 130°C  
0 - 450°C  
0 - 450°C   termi~ka `ica 1,5 m, Ø 3 mm  
0 - 999°C  
0 - 999°C   termi~ka `ica



NAZIVEN TEMOSTAT - Saem  
DVOEN

[ifra:           cena:

[ifra:           cena:



TERMOMETAR  
BEL Ø52, 0 - 120°C  
@OLT Ø52, 0 - 120°C

[ifra:           cena:



SOBEN TEMOSTAT  
Campini TA200/B2

[ifra:           cena:



TERMOMETAR  
0 - 120°C  
50 - 350°C  
-40 - 40°C

[ifra:           cena:

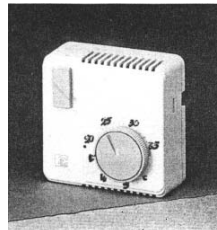

SOBEN TEMOSTAT  
Campini TY90/C4

[ifra:           cena:

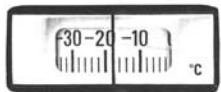

TERMOMETAR - MANOMETAR  
Ø52, 0 - 120°C

[ifra:           cena:

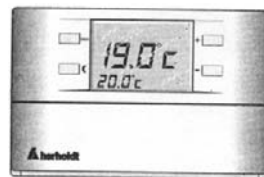

ELEKTRONSKI  
SOBEN TEMOSTAT  
Plus 1000

[ifra:           cena:



TERMOMETAR  
Ø52, 0 - 120°C

[ifra:           cena:

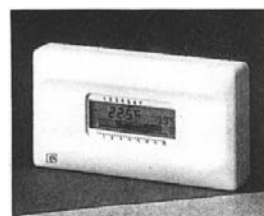

ELEKTRONSKI  
PROGRAMABILEN  
SOBEN TEMOSTAT  
TY 192

[ifra:           cena:

Servis i prodavnica:  
Bra}a Mingovi 18, Bitola  
(stara ~ar{ija)  
tel./faks: 097 / 30-633  
Fabrika i prodavnica na golemo:  
Dame Grujev 177, Bitola  
(nas. mal pariz)  
tel./faks: 097 / 30-877

Zastapnik:



# ELEKTROLUKS - ELEKTROIMPORT



ELEKTROVENTIL  
ELF, 1/8", 4w/220V, 50Hz

[ifra:  
cena:



ELEKTROVENTIL  
ESM 1/2"FF, 4w/220V, 50Hz

[ifra:  
cena:



ELEKTROVENTIL  
ELN, 1/8", 4w/230V, 50Hz

[ifra:  
cena:



ELEKTROVENTIL ESM  
3/4"FF, 6w/230V, 50Hz  
1"FF, 6w/230V, 50Hz  
1 1/2"FF; 2"; 2 1/2"FF, 6w

[ifra:  
cena:



ELEKTROVENTIL  
ELT/D, 1/8", 4w/230V, 50Hz

[ifra:  
cena:



ELEKTROVENTIL  
ELV, 1/8", 4w/230V, 50Hz

[ifra:  
cena:

ELEKTROVENTIL  
EST 3/8", 12w/230V, 50Hz  
1/2"FF, 12w/220V

[ifra:  
cena:

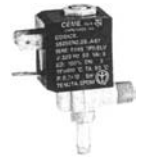

PRESOSTAT  
PN, 1/4"  
VOZDU[EN, CILINDRI^EN

[ifra:  
cena:



ELEKTROVENTIL ZA PAREA  
1/2"F, INOX 180C

[ifra:  
cena:



ELEKTROVENTIL  
1/4", 6w/220V, 50Hz

[ifra:  
cena:



PUMPA  
AMG 2000

[ifra:  
cena:



ELEKTROVENTIL  
SO REGULACIJA  
6w/220V, 50Hz

[ifra:  
cena:



PUMPA  
ET 500

[ifra:  
cena:



ELEKTROVENTIL  
SAE Neopren  
1/4", 6w/220v, 50Hz  
3/8", 2.8, 12w/220V

[ifra:      cena:

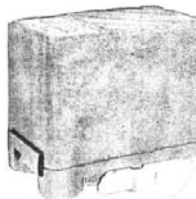

PRESOSTAT  
PM/5 - 5 Bar  
PT/12 III - 12 Bar  
PT/5 III - 5 Bar

[ifra:      cena:



NAMOTKA ZA VENTILI  
6724, 8514, 9314

[ifra:  
cena:

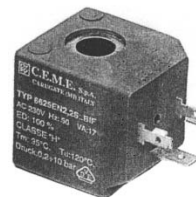

Servis i prodavnica:  
Bra}a Mingovi 18, Bitola  
(stara ~ar{ija)  
tel./faks: 097 / 30-633  
Fabrika i prodavnica na golemo:  
Dame Grujev 177, Bitola  
(nas. mal pariz)  
tel./faks: 097 / 30-877

Zastapnik:



# ELEKTROLUKS - ELEKTROIMPORT

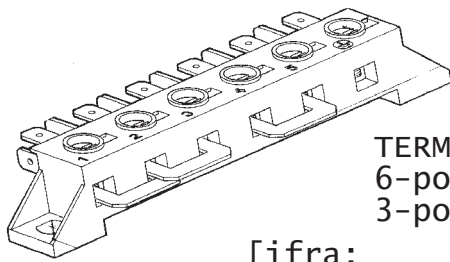

TERMINAL  
6-polen, 40A  
3-polen, 40A

[ifra:  
cena:

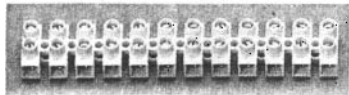

REDNA KLEMA  
POLIAMIDNA  
PLASTIČNA  
BAKELITNA

[ifra:  
cena:

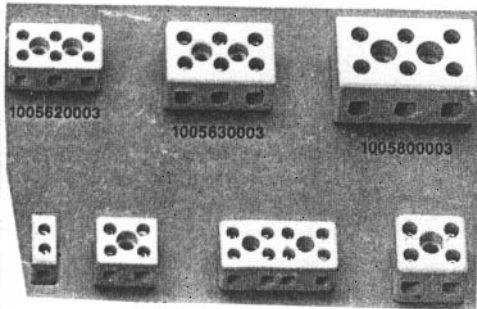

KERAMIČKI TERMINAL  
1 reden,  $\emptyset$  2,5 i  $\emptyset$  4  
2 reden,  $\emptyset$  2,5;  $\emptyset$  4-6 i  $\emptyset$  10  
2 reden,  $\emptyset$  2,5 bez dupka  
3 reden,  $\emptyset$  2,5;  $\emptyset$  4-6 i  $\emptyset$  10  
3 reden,  $\emptyset$  2,5 bez dupka

[ifra:  
cena:

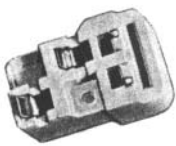

KERAMIČKI TERMINAL

[ifra:  
cena:

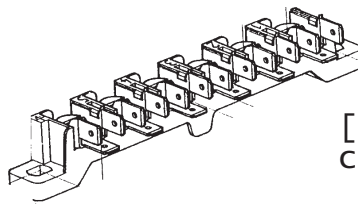
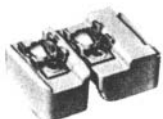

TERMINAL

[ifra:  
cena:

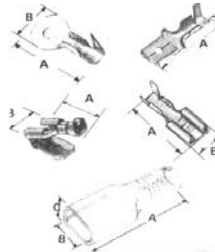

UTIKAČI  
MAŠKI: 0,5-2,5  
@ENSKI: 6.3, 2.8. 4.8  
DUPLI (M-@) 6.3-2.5  
SO DUPKA  $\emptyset$ 6.3,  $\emptyset$ 4.2,  $\emptyset$ 5.2  
ΔΕΛΙΑΝΙ UTIKAČI  
ΖΑΨΙΤΙΝΑ ΠΛΑΣΤΙΚΑ

[ifra:  
cena:

LEPILA ZA



HARTIJA



REPARIRAWE  
NA MAŠINI



PVC

Servis i prodavnica:  
Braća Mingovi 18, Bitola  
(stara varšija)  
tel./faks: 097 / 30-633  
Fabrika i prodavnica na golemo:  
Dame Gruev 177, Bitola  
(nas. mal pariz)  
tel./faks: 097 / 30-877

Zastupnik:



# ELEKTROLUKS - ELEKTROIMPORT

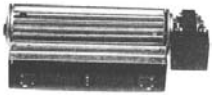

VENTILATOR  
12, 18, 24, 27 i 30 sm  
VENTILATOR SO POSTOQE  
12, 18 i 24 sm

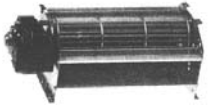

[ifra:  
cena:



GREAA ZA VENTILATOR  
18 sm

[ifra:           cena:

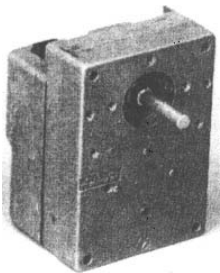

MOTOR SO REDUKTOR  
2, 6, 12, 18 vrte`i vo minuta

[ifra:  
cena:

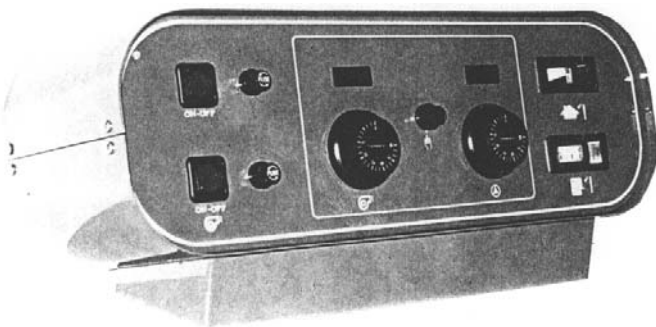

KOMANDNI KUTII ZA KOTLI ZA PARNO  
METALNI I PLASTI^ANI SO 1 ILI 2  
TERMOMETRI Ø52 ILI ^ETVRTASTI

[ifra:  
cena:

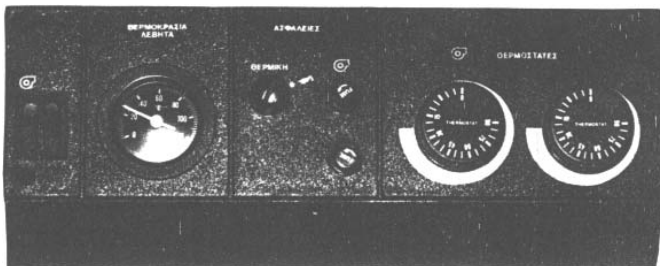

Servis i prodavnica:  
Braja Mingovi 18, Bitola  
(stara ~ar{ija)  
tel./faks: 097 / 30-633  
Fabrika i prodavnica na golemo:  
Dame Gruev 177, Bitola  
(nas. mal pariz)  
tel./faks: 097 / 30-877

Zastapnik:



# ELEKTROLUKS - ELEKTROIMPORT

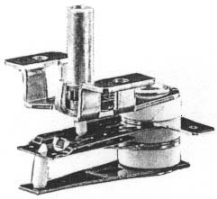

BIMETALEN TEMOSTAT

[ifra:           cena:

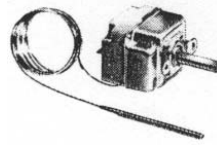

KERAMI^KKI TEMOSTAT  
50 - 300°C

[ifra:           cena:

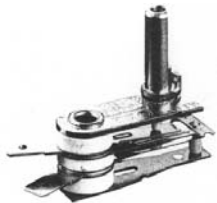

BIMETALEN TEMOSTAT ZA  
PEGLA (kratka osovina)  
TOSTER (dolga osovina)

[ifra:           cena:

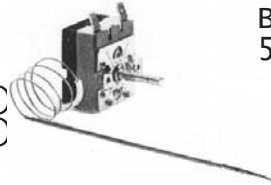

BAKELITEN TEMOSTAT  
50 - 300°C

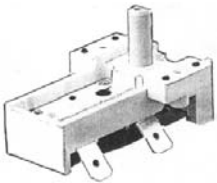

BEL BIMETALEN TEMOSTAT

[ifra:           cena:

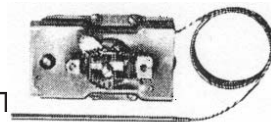

TEMOSTAT  
50 - 300°C, 20A  
130 - 370°C, 20A  
KAPA^E 50 - 130°C  
KAPA^E 130 - 370°C

[ifra:           cena:

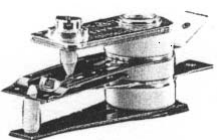

BIMETALEN SIGURNOSEN  
TEMOSTAT

[ifra:           cena:

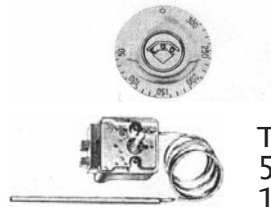

TEMOSTAT  
50 - 300°C, 16A  
130 - 370°C, 16A

[ifra:           cena:

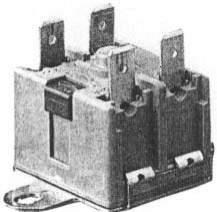

BIMETALEN SIGURNOSEN  
TEMOSTAT TY62

[ifra:           cena:

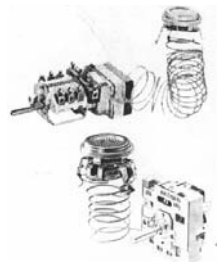

TEMOSTAT ZA RINGLA  
STAR TIP

NOV TIP

[ifra:           cena:

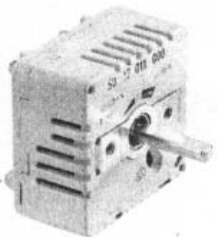

TEMOSTATSKI  
PREKINUVA^

[ifra:           cena:



TEMOSTAT  
TENOK  
DEBEL  
50 - 300°C, 380V

[ifra:           cena:

Servis i prodavnica:  
Bra}a Mingovi 18, Bitola  
(stara ~ar{ija)  
tel./faks: 097 / 30-633  
Fabrika i prodavnica na golemo:  
Dame Gruiev 177, Bitola  
(nas. mal pariz)  
tel./faks: 097 / 30-877

Zastapnik:



# ELEKTROLUKS - ELEKTROIMPORT

## PLETENI @ICI SO SILIKON

	0,50 mm
	0,75 mm
	1,00 mm
	1,50 mm
	2,50 mm
	4,00 mm
	6,00 mm

{ifra:           Cena:

## SILIKONSKI @ICI

	0,50 mm
	1,00 mm
	1,50 mm
	2,50 mm
	4,00 mm
	6,00 mm

{ifra:           Cena:

## SILIKONSKI KABLI

	2 H 0,75 mm
	3 H 0,75 mm
	3 H 1,50 mm
	3 H 1,00 mm
	3 H 2,50 mm
	4 H 0,75 mm
	4 H 1,00 mm
	4 H 1,50 mm
	4 H 2,50 mm

{ifra:           Cena:

## SILIKONSKA @ICA SO OKLOP

	3 H 1,50 mm
	3 H 2,50 mm
	4 H 1,50 mm
	4 H 2,50 mm

{ifra:           Cena:

## IZOLACIONO CREVO OD STAKLENI VLAKNA

	Ø 1 - Ø 16
	{ifra:
	Cena:

## IZOLACIONO SILIKONSKO CREVO

	Ø 4 i Ø 6
	{ifra:           Cena:
	IZOLACIONO TERMOSOBIRAAKO CREVO

	Ø 4,8; Ø 6,4 i Ø 9,5
	{ifra:           Cena:

Servis i prodavnica:  
Bra}a Mingovi 18, Bitola  
(stara ~ar{ija)  
tel./faks: 097 / 30-633  
Fabrika i prodavnica na golemo:  
Dame Gruev 177, Bitola  
(nas. mal pariz)  
tel./faks: 097 / 30-877



KANTAL @ICA ZA GREANJ

{ifra:           Cena:

Zastapnik:



# ЕЛЕКТРОЛУКС

## INDUSTRIJA ZA GREAČI



Стаклено - керамичките шпоретски грејни плочи користат топлински грејни елементи. Принципот на работа на овие грејни плочи е базиран на користење на намотани грејни жици монтирани во еден изолиран помошен сад вметнат во друг метален сад во облик на тава.

Целокупниот овај склоп се монтира под стаклената керамичка шпоретска плоча. Грејната жица има средна работна температура од  $1000^{\circ}\text{C}$ . Термостатот врши температурна заштита на стаклената плоча од надминување на  $600^{\circ}\text{C}$ .

Неодамнешните технолошки иновации имаат управување за делумна замена на грејната жица со халогена ламба со инфрацрвен енергетски спектар. Грејните жици односно изолацијата се дизајнирани да не го запираат инфрацрвеното зрачење насочено нагоре, но го редуцира колку што е можно повеќе страничното, а со тоа осигурува една висока ефикасност. Овие грејни елементи овозможуваат апаратите да постигнат работна температура на шпоретската плоча за многу кратко време.

### Структура:

- 1) канал за грејната жица; 2) Високо отпорен сад со изолација од температура, материјалот има мала топлинска проводливост, на сметка на хемискиот стабилен материјал; 3) термостат за температурна заштита од температури повисоки од  $600^{\circ}\text{C}$ ; 4) халоген сијалица, специјално дизајнирана за готварски функции, која гарантира минимум 5000 работни часови.

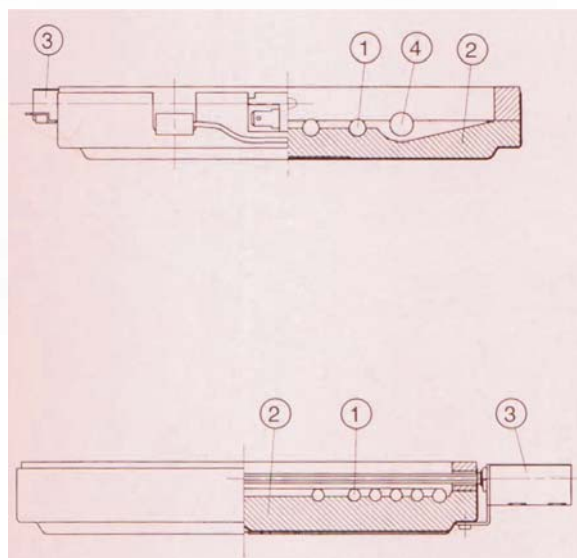





# ЕЛЕКТРОЛУКС

INDUSTRIJA ZA GREAOI

ELEKTROLUKS

## ЕКОНОМИЧНО ЗАТОПЛУВАЊЕ НА ВОДА SPA Heating Units



NEW



Основни технички спецификации:

- Грејно тело Ni-Cr легура INCOLOY 825, која нуди зголемена отпорност од корозија.
- Ниска густина на енергијата ( $< 7W/cm^2$ ) што нуди зголемен работен век на греачот.
- Далечинска контролна кутија за температурно поставување од  $5 - 45^{\circ}C/95^{\circ}C$ .
- Разновидна снага: 200W - 9kW на 230/380V
- Целокупна апаратура е опремена со 3 м долго гумирано кабел ( $3 \times 2.5/5 \times 2.5$ ) со приклучок погоден за надворешна употреба.
- Потребна сигурност. Висока изолациона отпорност ( $>500$  мегаоми) за превентива од струјни удари.
- Намена: за парно греење, аквариуми и затоплување на базени.

Address: ul. Braka Mingovi br.18, 7000 Bitola, R.Macedonia; Tel: +389 47 203-330 Faks: +389 47 203-900  
[www.elektroluks.com.mk](http://www.elektroluks.com.mk); [elek-palenzo@mt.net.mk](mailto:elek-palenzo@mt.net.mk)



# ЕЛЕКТРОЛУКС

## EXPORT - IMPORT

www.elektroluks.com.mk

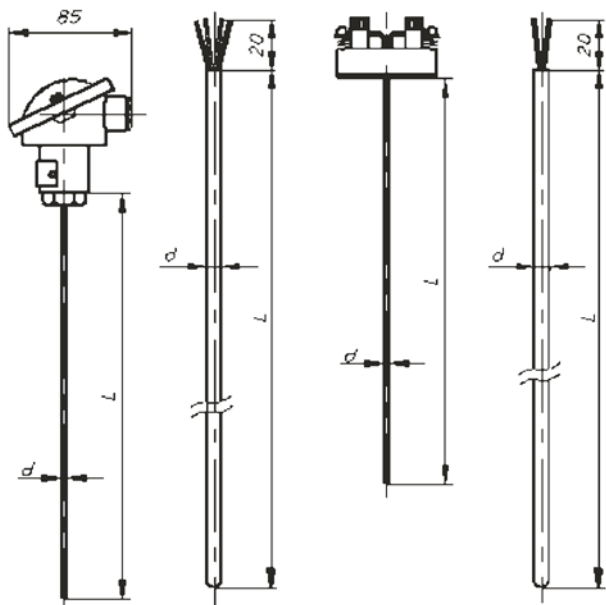

МАНТЕЛ ТЕРМОЕЛЕМЕНТИ НАОЃААТ СЕ ПОГОЛЕМА ПРИМЕНА ВО ТЕХНИЧКИТЕ МЕРЕЃА НА ТЕМПЕРАТУРА. ПОРАДИ СВОИТЕ МЕХАНИЧКИ И МЕРНО - ТЕХНИЧКИ ПРЕДНОСТИ ТИЕ ВО МНОГУ ОБЛАСТИ ГИ ЗАМЕНИЈА КЛАСИЧНИТЕ ТЕРМОЕЛЕМЕНТИ.

МАЛИТЕ НАДВОРЕШНИ ПРЕЧНИЦИ ОД Ф0.25ММ ДО Ф6ММ И ФЛЕКСИБИЛНОСТА ДОПУШТААТ ОПТИМАЛНО ПРИЛАГОДУВАЊЕ СО ОБЈЕКТОТ КОЈ СЕ МЕРИ. МИНИЈАТУРНИТЕ ЕЛЕМЕНТИ СО ОБВИВКА СЕ ОТПОРНИ НА АГРЕСИВНИ ОКОЛИНИ, ВИСОКИ ПРИТИСОЦИ И ВИБРАЦИИ, ЕДНОСТАВНИ СЕ ЗА МОНТАЖА И БРЗО РЕАГИРААТ НА ПРОМЕНА НА ТЕМПЕРАТУРАТА.

Надворешен пречник на заштитната цевка од (mm)	Материјал на заштитната цевка	Максимална температура	Катапошки Број	
			1 x NiCr - Ni	2 x NiCr - Ni
2	1.4541	850°C	T8 - 1212	-----
3			T8 - 1213	T8 - 2213
4.5			T8 - 1214	T8 - 2214
6			T8 - 1216	T8 - 2216
2	INCONEL	1100°C	T8 - 1222	-----
3			T8 - 1223	T8 - 2223
4			T8 - 1224	T8 - 2224
6			T8 - 1226	T8 - 2226
Надворешен пречник на заштитната цевка од (mm)	Материјал на заштитната цевка	Максимална температура	Катапошки Број	
3.2	1.4541	800°C	1 x NiCr - Ni	2 x NiCr - Ni
4.5			T8 - 1113	T8 - 2113
6			T8 - 1114	T8 - 2114
			T8 - 1116	T8 - 2116



# ELEKTROLUKS

Address: ul. Braka Mingovi br.18, 7000 Bitola, R.Macedonia; Tel: +389 47 203-330 Faks: +389 47 203-900  
www.elektroluks.com.mk; elek-palenzo@mt.net.mk



# ЕЛЕКТРОЛУКС

## EXPORT - IMPORT

www.elektroluks.com.mk

### ТЕРМОЕЛЕМЕНТИ И ОТПОРНИ ТЕРМОМЕТРИ СПЕЦИЈАЛНА ИЗРАБОТКА Т7 - 0000

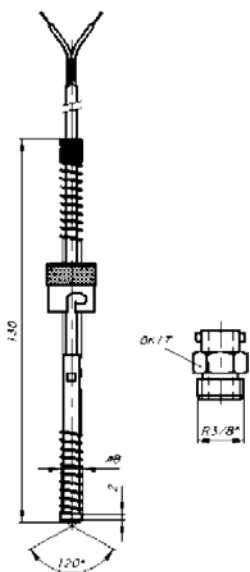

*Опшорен термометар со бајонет приклучок до 250C - За мерење на температурата на машини за преработка на пластични маси, и сл.*

*Мерен опшор: Pt 100 (JUS L.F2.051) фиксно поврзан за температурно опшорен кабел со должина од 2м (и поголеми должини по потреба).*

*Вградена должина: 40...150мм, се подесува со поместување на матицајта вдоль ојружјајта*

*Каталошки број: Т7 - 1431*

*Термоелемент со бајонет приклучок до 400C - За мерење на температурата на машиније за преработка на пластични маси и сл.*

*Термоелемент: Fe-CuNi (JUS L.F2.008)*

*Компензационен кабел: L=3м, фиксно поврзан*

*Вградена должина: 40...150мм, се подесува со поместување на матицајта вдоль ојружјајта*

*Каталошки број: Т7 - 1131*

*Обратниот дел G3/8 со бајонет приклучок се искорачува со опшорен термометар или термоелемент.*

#### ПРАВ ТЕРМОЕЛЕМЕНТ (крајок)

Приклучна глава според DIN 43729 тип А или тип В

1 термопар NiCr-Ni според JUS L.F2.011

Носива цев 22x2, материјал С.1214

Заштитна цевка 15x2, материјал KER 610

L1	L2	Каталошки број
250	35	T7 - 1211
330	40	T7 - 1212

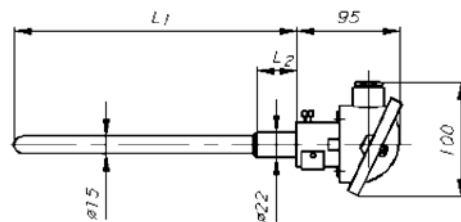

#### ОТПОРЕН ТЕРМОМЕТАР (без поврзана цевка)

Приклучна глава според DIN 43729 тип В

Мерни опшор 1 x Pt 100 според JUS L.F2.051

Материјал на заштитна цевка 11x2: С.4574

L(mm)	130	160	385	500
Каталошки бр.	T7 1421	T7 1422	T7 1423	T7 1423

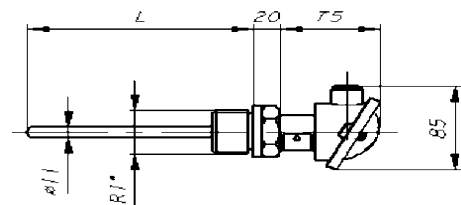

# ELEKTROLUKS

Address: ul. Braќa Mingovi br.18, 7000 Bitola, R.Macedonia; Tel: +389 47 203-330 Faks: +389 47 203-900

www.elektroluks.com.mk; elek-palenzo@mt.net.mk



# ЕЛЕКТРОЛУКС

## EXPORT - IMPORT

### ТЕРМОЕЛЕМЕНТИ - ОТПОРНИ ТЕРМОМЕТРИ ДИГИТАЛНИ ТЕРМОРЕГУЛАТОРИ РАЧНИ ДИГИТАЛНИ ТЕРМОМЕТРИ

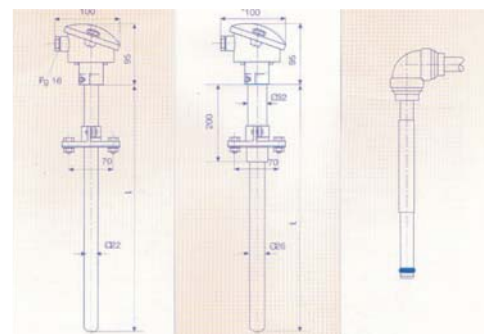

NAZIV	PRAVI TERMOELEMENTI T2 - XXXX	PRAVI TERMOELEMENTI T1 - XXXX	UGAONI TERMOELEMENTI T3 - XXXX
TERMO PAR	NiCr-NiAl, Tip K, Fe-CuNi Tip J (DIN IEC 584-1)	Pt-Rh(10%)/Pt, Tip S, Pt-Rh(13%)/Pt, Tip R, Pt-Rh(30%)/Pt-Rh(10%), Tip B (DIN IEC 584-1)	NiCr-NiAl, Tip K, Fe-CuNi Tip J, Pt-Rh(10%)/Pt, Tip S (DIN IEC 584-1)
ZAŠTITNA CEV	ø 22 x 2 St. 35, 8. emajirano ø 22 x 2 Č 4970 ø 22 x 2 Č 4578	Keramika KER 710 ø 15 x 2 Keramika KER 610 ø 15 x 2 Keramika KER 530 ø 26 x 4	Tehnički čisto gvožđe Čelik SL 25 Čelik W.Nr. 1.4772 Metal. keramika
NAZIVNA DUŽINA	L = 500 mm L = 710 mm L = 1000 mm L = 1400 mm L = 2000 mm	L = 500 mm L = 710 mm L = 1000 mm L = 1400 mm L = 2000 mm	L <sub>1</sub> = 500 mm L <sub>1</sub> = 710 mm L <sub>1</sub> = 1000 mm

TERMOELEMENTI I OTPORNI TERMOMETRI SA BAJONET PRIKLJUCKOM T7 - XXXX	TERMOELEMENTI I OTPORNI TERMOMETRI SPECIJALNE IZRADE T7 - XXXX	TERMOELEMENTI I OTPORNI TERMOMETRI ZA UVRTANJE T6 - XXXX	MANTEL TERMOELEMENTI T8 - XXXX
Fe-CuNi, Tip J (DIN IEC 584-1) Pt 100	NiCr-NiAl, Tip K, Fe-CuNi, Tip J (DIN IEC 584-1) Pt 100	NiCr-NiAl, Tip K, Fe-CuNi, Tip J (DIN IEC 584-1) Pt 100	NiCr-NiAl, Tip K, Fe-CuNi, Tip J (DIN IEC 584-1)
Č 4572 Č 4574 Č 7400	Č 4572 Č 4574 Č 7400	Č 4572 Č 4574 Č 7400	Mantel termoelementi nalaze se u veći prečnik u odnosu na merenu temperaturu. Zbog toga mehanizmi i materijali izrađeni su u ovoj oblasti izuzetno kvalitetno i precizno. Naj veći prečnik od 6,25 mm do 6 m. Pokušajte kupiti za 1 tip u veći stepenja otpornosti prilagođavajući objekt koji se meri. Manjati termoelementi su priključeni i povezani na odgovarajuće vrste priključaka i vrtanje, jedinstveni su za montažu i bez potrebe za promenu temperature.
L = 160 mm L = 250 mm	L = 160 mm L = 250 mm	L = 160 mm L = 250 mm	

#### 1. Термоелементи и отпорни термометри

- Прави термоелементи со термопар Pt-Rh (10%)/Pt, Tip S; DIN IEC 584-1

- Прави термоелементи со термопар: Pt-Rh (30%)/Pt-Rh (6%), Tip B; DIN IEC 584-1

- Прави термоелементи со термопар: Fe-CuNi, Tip J; DIN IEC 584-1

- Манџел термопаров пречник 2 - 8мм; NiCr-NiAl, Tip K; DIN IEC 584-1

- Овојорни термометри за навршување и заварување со илаински овојорен термометар; Tip Pt 100

- Азобен термоелемент со термопар: NiCr-NiAl, Ti K, или Fe-CuNi, Tip J; или Pt-Rh (10%)/Pt, Tip S

- Термоелементи и овојорни термометри за чадни канали со манџел мерна уложка со термопар NiCr-NiAl, Tip K, или со манџел уложка со илаински овојорен термометар, Tip Pt 100

- Термоелементи со навршување со манџел мерна уложка со термопар NiCr-NiAl, Tip K; или со манџел мерна уложка со термопар Fe-CuNi, Tip J

- Термоелемент за навршување со манџел мерна уложка со термопар NiCr-NiAl, Tip K, или со манџел мерна уложка со термопар Fe-CuNi, Tip J

- Термоелементи и овојорни термометри специјални изработки по барање на кувачоци

2. Дигитални терморегулатори TT - 000

3. Рачен дигитален термометар TM - 300



# ELEKTROLUKS

Address: ul. Braka Mingovi br.18, 7000 Bitola, R.Macedonia; Tel: +389 47 203-330 Faks: +389 47 203-900

www.elektroluks.com.mk; elek-palenzo@mt.net.mk



# ЕЛЕКТРОЛУКС

EXPORT - IMPORT

[www.elektroluks.com.mk](http://www.elektroluks.com.mk)

## ТЕРМОЕЛЕМЕНТИ - ОТПОРНИ ТЕРМОМЕТРИ ДИГИТАЛНИ ТЕРМОРЕГУЛАТОРИ РАЧНИ ДИГИТАЛНИ ТЕРМОМЕТРИ



*Понајмошнички развој на ЕЛЕКТРОЛУКС насочен е на перманентно следење на производите во експлоатацијата во соработка со кувачите, истоа, следење на конкуренцијата на домашниот и надворешниот пазар и развој на нови производи самостојно или во соработка со познатите шведски фирми од областа на мерењето на температурата и уредите за регулација на температурата.*

*Во блиска иднина ЕЛЕКТРОЛУКС се стремиме кон формирање на мешовитата фирма со странски партнери, чија активност ќе се одвива во нашата и други земји, а успешна соработка веќе е остварена со фирмите: Termotekna, Heraeus, Reckmann, Hartman & Braun, Yung Chan Electrical instruments, Jumo.*



# ELEKTROLUKS

Address: ul. Braka Mingovi br.18, 7000 Bitola, R.Macedonia; Tel: +389 47 203-330 Faks: +389 47 203-900

[www.elektroluks.com.mk](http://www.elektroluks.com.mk); [elek-palenzo@mt.net.mk](mailto:elek-palenzo@mt.net.mk)



# ЕЛЕКТРОЛУКС

## EXPORT - IMPORT

www.elektroluks.com.mk

### ТЕРМОЕЛЕМЕНТИ И ОТПОРНИ ТЕРМОМЕТРИ ЗА НАВРТУВАЊЕ Т6 - 0000

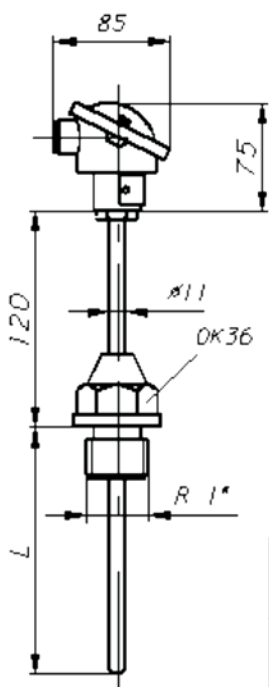

Прикључна глава: облик В - DIN 43729

Мерен уложак: 6 mm

Обраќен дел: G 1/2, G1

Дозволјена брзина стјурања:

- за воздух: 9m/s

- за вода: 2 m/s

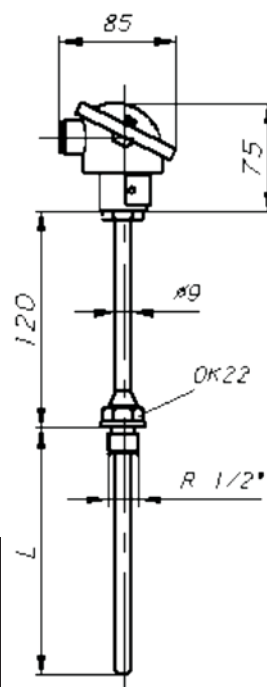

					Каталошки број	
Температура	Термопар	Зайцева цевка	Називна должина L (мм)	Должина мернои уложак L (мм)	1 Термопар	2 Термопар
До 400 C	Fe-CuNi	F9 x 1,5 С.4572 W.Nr.1.4571	160 250	315 405	T6 - 1111 T6 - 1112	T6 - 2111 T6 - 2112
До 400 C	NiCr-Ni	F9 x 1,5 С.4572 W.Nr.1.4571	160 250	315 405	T6 - 1211 T6 - 1212	T6 - 2211 T6 - 2212
До 500 C	Fe-CuNi	F11 x 2 С.7400 W.Nr.1.7335	160 250	315 405	T6 - 1121 T6 - 1122	T6 - 2121 T6 - 2122
До 500 C	NiCr-Ni	F11 x 2 С.7400 W.Nr.1.7335	160 250	315 405	T6 - 1221 T6 - 1222	T6 - 2221 T6 - 2222

					Каталошки број	
Температура	Мерен отпор	Зайцева цевка	Називна должина L (мм)	Должина мернои уложак L (мм)	1 x Pt100	2 x Pt100
До 400 C	Pt 100	F9 x 1,5 С.4572 W.Nr.1.4571	160 250	315 405	T6 - 1411 T6 - 1412	T6 - 2411 T6 - 2412
До 500 C	Pt 100	F11 x 2 С.7400 W.Nr.1.7335	160 250	315 405	T6 - 1421 T6 - 1422	T6 - 2421 T6 - 2422

 ELEKTROLUKS

Address: ul. Braka Mingovi br.18, 7000 Bitola, R.Macedonia; Tel: +389 47 203-330 Faks: +389 47 203-900

www.elektroluks.com.mk; elek-palenzo@mt.net.mk



# ЕЛЕКТРОЛУКС

## EXPORT - IMPORT

www.elektroluks.com.mk

### ТЕРМОЕЛЕМЕНТИ И ОТПОРНИ ТЕРМОМЕТРИ ЗА ЗАВАРУВАЊЕ T5 - 0000

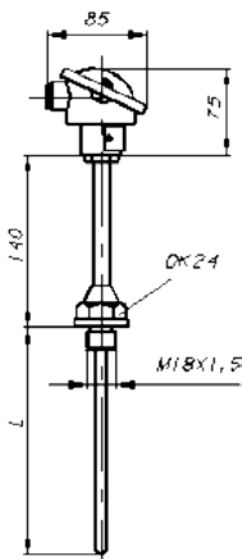

**Прикапна глава:**  
облик В - DIN 43729  
**Мерна уложка:** 6mm

Температура	Мерен ојџор	Називна должина L (мм)	Должина мерниот уложак L (мм)	Каталожни број	
				1 Термопар	2 Термопара
до 540°C	Fe-CuNi 1 mm	140	315	T5-1111	T5-2111
		200	375	T5-1112	T5-2112
до 540°C	NiCr-Ni 1 mm	140	315	T5-1211	T5-2211
		200	375	T5-1212	T5-2212

Температура	Називна должина L (mm)	Должина на мерниот уложак (mm)	Каталожни број	
			1 x Pt 100	2 x Pt 100
до 400°C	140	315	T5-1411	T5-2411
	200	375	T5-1412	T5-2412
преку 400°C	140	315	T5-1411.6	T5-2411.6
	200	375	T5-1412.6	T5-2412.6

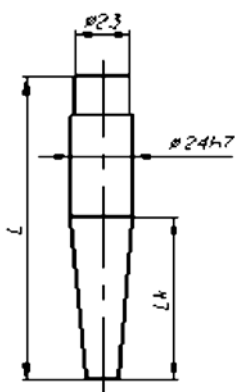

Се изработува со Бушење на поплн материјал  $\Phi 24$  со конусен завршеток Tip D – DIN 43763. Оптеретувањето на заштитната цевка за заварување според DIN 43763 зависи од неколку фактори, а тоа се: типот на терната околина, неговата температура, притисокот и брзината на струење, потоа материјалот на заштитната цевка и должината на загревање.

Називна должина L (mm)	Должина на конусот Lk (mm)	Материјал
140	65	C 7400
200	125	W.Nr. 1.7335
140	65	C. 7401
200	125	W.Nr. 1.7380

 ELEKTROLUKS

Address: ul. Braka Mingovi br.18, 7000 Bitola, R.Macedonia; Tel: +389 47 203-330 Faks: +389 47 203-900  
www.elektroluks.com.mk; elek-palenzo@mt.net.mk



# ЕЛЕКТРОЛУКС

## EXPORT - IMPORT

www.elektroluks.com.mk

### ПРАВИ ТЕРМОЕЛЕМЕНТИ СО ТЕРМОПАР PtRh - Pt T1 - 0000

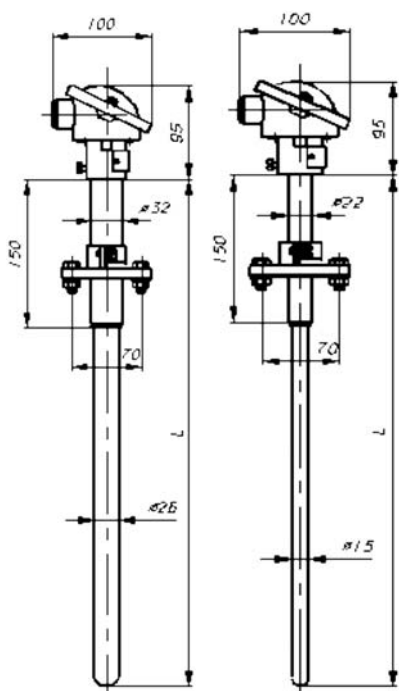

<u>ПРИМЕНА</u>		
<i>Материјал на заштитната цевка</i>	<i>Употребливо до (°C)</i>	
<i>Термоелемент - њорцалан (KER 610)</i>	<i>1500</i>	<i>За сите часови без присуство на механички киселини и алкална пара</i>
<i>Оксидна керамика (KER710)</i>	<i>1600</i>	<i>За алкална пара - ички за топење на стакло и сл.</i>
<i>Порозна керамика (KER 530)</i>	<i>1600</i>	<i>За сите часови. Оптимална на температурни шокови</i>

<i>Температура</i>	<i>Заштитна цевка</i>	<i>Називна должина</i>	<i>Каталожки број</i>	
			<i>1 Термопар</i>	<i>2 Термопара</i>
<i>До 1500°C</i>	<i>Термоелемент њорцалан 15 x 2 (KER 610)</i>	<i>500</i>	<i>T1-1361</i>	<i>T1-2361</i>
		<i>710</i>	<i>T1-1362</i>	<i>T1-2362</i>
		<i>1000</i>	<i>T1-1363</i>	<i>T1-2363</i>
		<i>1400</i>	<i>T1-1364</i>	<i>T1-2364</i>
<i>До 1600°C</i>	<i>Оксидна керамика 15 x 2,5 (KER 710)</i>	<i>500</i>	<i>T1-1371</i>	<i>T1-2371</i>
		<i>710</i>	<i>T1-1372</i>	<i>T1-2372</i>
		<i>1000</i>	<i>T1-1373</i>	<i>T1-2373</i>
		<i>1400</i>	<i>T1-1374</i>	<i>T1-2374</i>
<i>До 1600°C</i>	<i>Порозна керамика 26 x 4 KER 530 са внатрешна цевка 15 x 2 (KER 610)</i>	<i>500</i>	<i>T1-1351</i>	<i>T1-2351</i>
		<i>710</i>	<i>T1-1352</i>	<i>T1-2352</i>
		<i>1000</i>	<i>T1-1353</i>	<i>T1-2353</i>
		<i>1400</i>	<i>T1-1354</i>	<i>T1-2354</i>

 ELEKTROLUKS

Address: ul. Braka Mingovi br.18, 7000 Bitola, R.Macedonia; Tel: +389 47 203-330 Faks: +389 47 203-900  
www.elektroluks.com.mk; elek-palenzo@mt.net.mk





# ЕЛЕКТРОЛУКС

## EXPORT - IMPORT

www.elektroluks.com.mk

### ПРАВ ТЕРМОЕЛЕМЕНТ Т2 - 0000

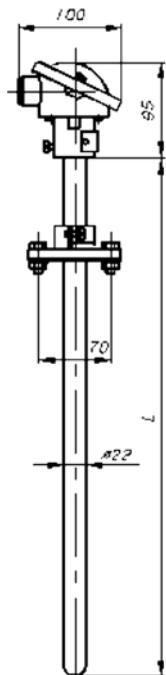

Материјал на заштитната цевка	Употребиливо до (°C)	Постојаност		
		Во сумјорна атмосфера		Во азотна атмосфера сиромашна со киселина
		Оксидирачка	Редуциона	
St.35.8	550	Мала	Мала	Средна
C.4970 W.Nr. 1.4762	1200	Многу голема	Голема	Мала
C.4578 W.Nr. 1.4841	1200	Мала	Мала	Голема

Температура	Термопар	Заштитна цевка Ф22 x 2	Називна должина L (mm)	Каталожни број	
				1 Термопар	2 Термопара
До 700°C	Fe-CuNi	St 35.8 емајлирана	500	T2-1121	T2-2121
			710	T2-1122	T2-2122
			1000	T2-1123	T2-2123
До 700°C	NiCr-Ni	St 35.8 емајлирана	500	T2-1221	T2-2221
			710	T2-1222	T2-2222
			1000	T2-1223	T2-2223
До 1200°C	NiCr-Ni	C.4970 W.Nr.1.4762	500	T2-1231	T2-2231
			710	T2-1232	T2-2232
			1000	T2-1233	T2-2233
			1400	T2-1234	T2-2234
			2000	T2-1235	T2-2235
До 1200°C	NiCr-Ni	C.4578 W.Nr.1.4841	500	T2-1241	T2-2241
			710	T2-1242	T2-2242
			1000	T2-1243	T2-2243
			1400	T2-1244	T2-2244
			2000	T2-1245	T2-2245

 ELEKTROLUKS

Address: ul. Braka Mingovi br.18, 7000 Bitola, R.Macedonia; Tel: +389 47 203-330 Faks: +389 47 203-900

www.elektroluks.com.mk; elek-palenzo@mt.net.mk



# ЕЛЕКТРОЛУКС

## EXPORT - IMPORT

www.elektroluks.com.mk

### АГОДЕН ТЕРМОЕЛЕМЕНТ ТЗ - 0000

Материјал на заштитна цевка	Упојребливо до температура	Околина
Технички чисто железо	550°C 950°C	Шалијра цијан
SL 25 X20CrNiSi2 54	1300°C	

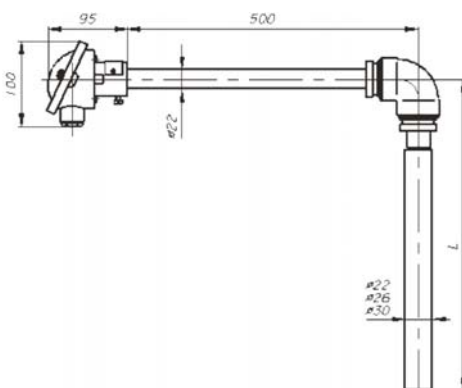

За растийени метали		
Материјал на заштитна цевка	Упојребливо до температура	Околина
Технички чисто железо	700°C 650°C 600°C	Алуминиум косијар цинк
X10CrSi29	900°C 1250°C	Месинџ Бакар

Температура	Термопар	Заштитна цевка Φ22 x 2	Називна должина L (mm)	КАТАЛОШКИ БРОЈ	
				1 Термопар	2 Термопара
do 700°C	Fe-CuNi	Технички чисто железо W.Nr.1.1003	500	T3-1111	T3-2111
			710	T3-1112	T3-2112
			1000	T3-1113	T3-2113
do 950°C	NiCr-Ni	Технички чисто железо W.Nr.1.1003	500	T3-1211	T3-2211
			710	T3-1212	T3-2212
			1000	T3-1213	T3-2213
do 950°C	NiCr-Ni	Технички чисто железо W.Nr.1.1003	500	T3-1221	T3-2221
			710	T3-1222	T3-2222
			1000	T3-1223	T3-2223
do 1200°C	NiCr-Ni	X10CrSi29 W.Nr.1.4772 26 x 4	500	T3-1221	T3-2221
			710	T3-1222	T3-2222
			1000	T3-1223	T3-2223
do 1250°C	PtRh-Pt	X20CrNiSi254 SL 25 C.4586	500	T3-1331	T3-2331
			710	T3-1332	T3-2332
			1000	T3-1333	T3-2333

 ELEKTROLUKS

Address: ul. Braka Mingovi br.18, 7000 Bitola, R.Macedonia; Tel: +389 47 203-330 Faks: +389 47 203-900

www.elektroluks.com.mk; elek-palenzo@mt.net.mk



**ЕЛЕКТРОЛУКС**  
DIREKTEN UVOZNIK

ELEKTROLUKS



**GoldStar**  
**Miniature Circuit Breaker**



**General Electric**



**MERLIN GERIN**  
**multi 9**

## АВТОМАТСКИ ОСИГУРАЧИ

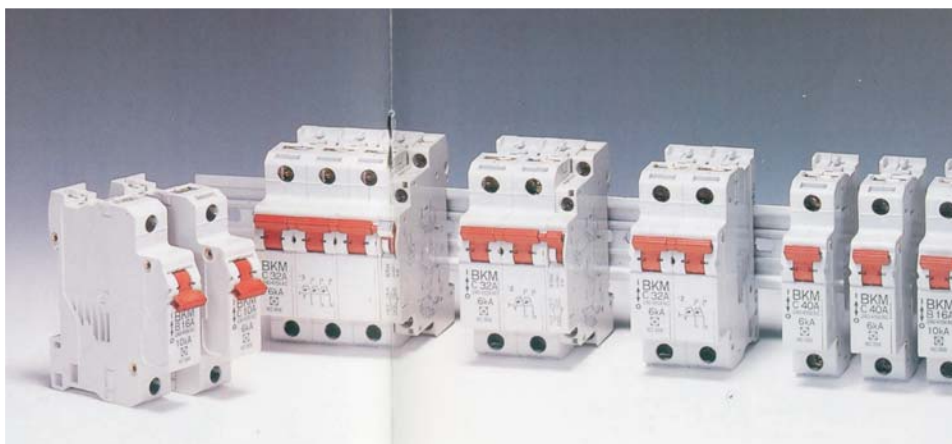



# ELEKTROLUKS

INDUSTRIJA ZA GUMENI  
PROIZVODI

**G-1**

CREVO INDESIT



**ELEKTROLUKS**

**G-2**

CREVO VOZDUH  
GORENJE 664



**ELEKTROLUKS**

**G-3**

CREVO VOZDUH  
EI



**ELEKTROLUKS**

**G-4**

CREVO MORIS  
MASINA ZA SADOVI



**ELEKTROLUKS**

**G-5**

TAPA ZA TERMOSTAT



**ELEKTROLUKS**



# ELEKTROLUKS

INDUSTRIJA ZA GUMENI  
PROIZVODI

**G - 6**

GUMA ZA TERMOSTAT  
F12



**ELEKTROLUKS**

**G - 7**

GUMA ZA TERMOSTAT  
F10



**ELEKTROLUKS**

**G - 8**

KONDEZATOR  
8,10,12,14,16,20,25,30,35



**ELEKTROLUKS**

**G - 9**

LAGERI



**ELEKTROLUKS**

**G - 10**

EL. MAGN. VENTIL  
EDNOPOLEN



**ELEKTROLUKS**



# ELEKTROLUKS

INDUSTRIJA ZA GUMENI  
PROIZVODI

**G - 11**

EL.MAG.VENTIL  
TROPOLEN

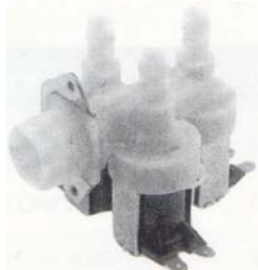

**ELEKTROLUKS**

**G - 12**

EL.MAG.VENTIL  
DVOPOLEN

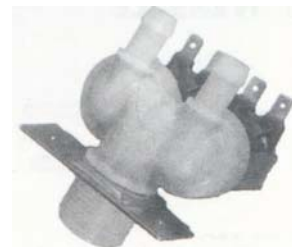

**ELEKTROLUKS**

**G - 13**

EL.MAG.RELE



**ELEKTROLUKS**

**G - 14**

EL.MAG.SPULNA  
ZA  
PROGRAMATOR



**ELEKTROLUKS**

**G - 15**

EL.MAG.SPULNA  
ZA  
PROGRAMATOR



**ELEKTROLUKS**



# ELEKTROLUKS

INDUSTRIJA ZA GUMENI  
PROIZVODI

**G - 16**

EL.MAG.PUMPA  
ZA  
LEDOMAT

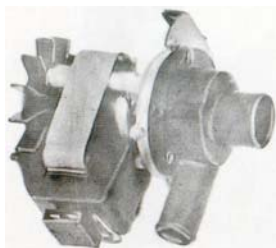

**ELEKTROLUKS**

**G - 17**

EL.MAG.PUMPA

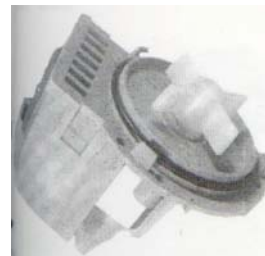

**ELEKTROLUKS**

**G - 18**

EL.MAG.PUMPA  
ZA EI

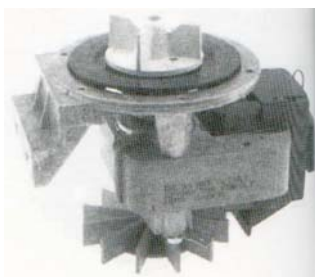

**ELEKTROLUKS**

**G - 19**

HIDROSTAT  
SO 3 KONTAKTI



**ELEKTROLUKS**

**G - 20**

HIDROSTAT  
SO 6 KONTAKTI



**ELEKTROLUKS**



# ELEKTROLUKS

INDUSTRIJA ZA GUMENI  
PROIZVODI

**G - 21**

HIDROSTAT  
SO 7 KONTAKTI



**ELEKTROLUKS**

**G - 22**

TASTER PREKIDAC  
SP LAMBICE



**ELEKTROLUKS**

**G - 23**

TINJALICA  
(SVETLOSNA LAMBA)

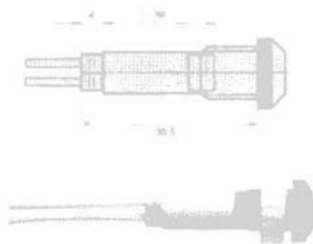

**ELEKTROLUKS**

**G - 24**

MIKRO PREKIDAC

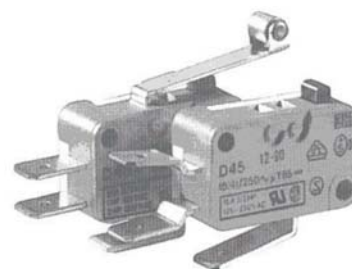

**ELEKTROLUKS**

**G - 25**

TERMOSTAT ZA  
MAS.PERACKA  
EI



**ELEKTROLUKS**





# ELEKTROLUKS

INDUSTRIJA ZA GUMENI  
PROIZVODI

**G - 26**

TERMOSTAT ZA  
MAS.PERACKA  
GORENJE  
SO 4 KONTAKTI



**ELEKTROLUKS**

**G - 27**

TERMOSTAT ZA  
MAS.PERACKA  
MORIS

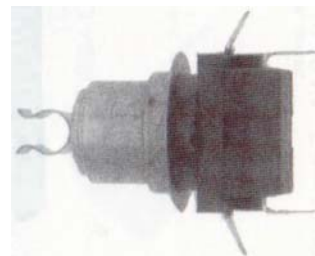

**ELEKTROLUKS**

**G - 28**

TERMOSTAT ZA  
MAS.PERACKA  
OBOD  
SO 3 KONTAKTI



**ELEKTROLUKS**

**G - 29**

TERMOSTAT ZA  
MAS.PERACKA  
GORENJE  
SO 3 KONTAKTI



**ELEKTROLUKS**

**G - 30**

EL.MAGN.BRAVA  
ZA MAS.PERACKA  
EI



**ELEKTROLUKS**



# ELEKTROLUKS

INDUSTRIJA ZA GUMENI  
PROIZVODI

**G - 31**

EL.MAGN.BRAVA  
ZA MAS.PERACKA  
GORENJE



**ELEKTROLUKS**

**G - 32**

REMENICA  
ZA MAS.PERACKA  
GORENJE



**ELEKTROLUKS**

**G - 33**

REMENICA  
ZA MAS.PERACKA  
EI



**ELEKTROLUKS**

**G - 34**

REMENICA  
ZA MAS.PERACKA  
OBOD



**ELEKTROLUKS**

**G - 35**

AMORTIZER 663  
ZA  
MAS. PERACKA  
EI



**ELEKTROLUKS**



# ELEKTROLUKS

## INDUSTRIJA ZA GUMENI PROIZVODI

**G - 36**

AMORTIZER 664  
ZA  
MAS. PERACKA  
EI

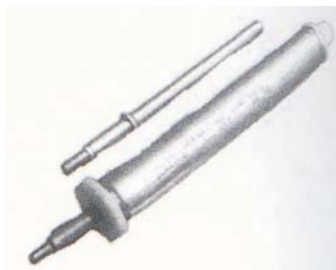

**ELEKTROLUKS**

**G - 37**

BUBANJ  
ZA  
MAS. PERACKA  
OBOD, GORENJE  
EI, FAVORIT

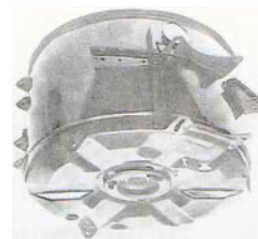

**ELEKTROLUKS**

**G - 38**

STAKLO ZA VRATA  
ZA  
MAS. PERACKA  
EI



**ELEKTROLUKS**

**G - 39**

STAKLO ZA VRATA  
ZA  
MAS. PERACKA  
OBOD



**ELEKTROLUKS**

**G - 40**

FILTER ZA  
MAS. PERACKA 664  
GORENJE

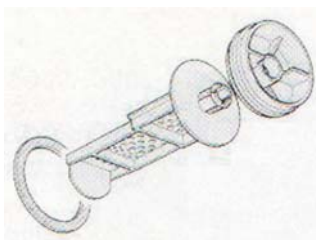

**ELEKTROLUKS**



# ELEKTROLUKS

INDUSTRIJA ZA GUMENI  
PROIZVODI

**G - 41**



**ELEKTROLUKS**

**G - 42**

FILTER ZA  
MAS.PERACKA 620  
GORENJE



**ELEKTROLUKS**

**G - 43**

RACE ZA VRATA  
MAS.PERACKA  
GORENJE



**ELEKTROLUKS**

**G - 44**

RACE ZA VRATA  
MAS.PERACKA  
GORENJE



**ELEKTROLUKS**

**G - 45**

RACE ZA VRATA  
MAS.PERACKA



**ELEKTROLUKS**



# ELEKTROLUKS

INDUSTRIJA ZA GUMENI  
PROIZVODI

**G - 46**

GUMENA PERKA  
ZA OBOD K5



**ELEKTROLUKS**

**G - 47**

SARKA - REZE  
EI  
METAL

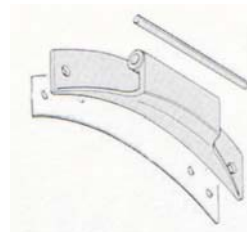

**ELEKTROLUKS**

**G - 48**

SARKA - REZE  
EI  
ALUMINIUM

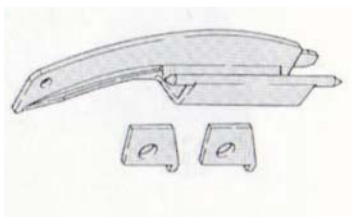

**ELEKTROLUKS**

**G - 49**

SARKA - REZE  
GORENJE 664



**ELEKTROLUKS**

**G - 50**

**ELEKTROLUKS**



# ELEKTROLUKS

INDUSTRIJA ZA GUMENI  
PROIZVODI

ELEKTROLUKS

## GRIFNI I ROZETI





# ELEKTROLUKS

## INDUSTRIJA ZA GUMENI PROIZVODI

### CREVA ZA MASINA PERACKA



NYLON

PLASTICEN FITING

NYLON



METAL

METALEN FITING

METAL

Code	Mt.	Notes
<b>110.00.00</b>	1,5	
<b>110.00.01</b>	2	
<b>110.00.02</b>	2,5	
<b>110.00.03</b>	3	
<b>110.00.04</b>	1,5	
<b>110.00.07</b>	2	
<b>110.00.08</b>	3	
<b>110.00.11</b>	2,5	
<b>110.00.12</b>		
<b>110.00.13</b>		
<b>110.00.16</b>	2	
<b>110.00.17</b>	3,5	



### ODVODNI CREVA ZA MASINA PERACKA



Code	Mt.	Notes
<b>111.00.00</b>	1,5	
<b>111.00.01</b>	2	
<b>111.00.02</b>	2,5	
<b>111.00.03</b>	3	
<b>111.13.01</b>	2	

ELEKTROLUKS



# ЕЛЕКТРОЛУКС

INDUSTRIJA ZA GUMENI  
PROIZVODI

## STEGI INOX



Code	Dimensions	Note
<b>532.00.00</b>	8 - 16	
<b>532.00.01</b>	12 - 20	
<b>532.00.02</b>	20 - 32	
<b>532.00.03</b>	25 - 40	
<b>532.00.04</b>	40 - 60	
<b>532.00.05</b>	50 - 70	
<b>532.00.06</b>	60 - 80	
<b>532.00.07</b>	16 - 25	
<b>532.00.08</b>	32 - 50	
<b>532.00.09</b>	70 - 90	
<b>532.00.10</b>	12 - 18	

ELEKTROLUKS





# ELEKTROLUKS

## INDUSTRIJA ZA GUMENI PROIZVODI

### SIMERINZI ZA MASINA PERACKA



Code	Dimensions	Brand Name	Type
<b>124.00.02</b>	6X22X7	UNIVERSALE	G2SM
<b>124.00.03</b>	22X40X8/11,5	ZANUSSI	GP
<b>124.00.04</b>	23X47X10	ZEROWATT	G
<b>124.11.01</b>	45X75X10	AEG	GP
<b>124.11.02</b>	40X70/80X12/14	AEG	G2FS
<b>124.11.03</b>	35X65/76X13	AEG	GPF
<b>124.11.04</b>	45X78/88X12/15	AEG	G2FS
<b>124.11.05</b>	45X75,2/81X10,5/14,5	AEG	GPF
<b>124.13.00</b>	20X40X7	SANGIORGIO	G
<b>124.13.01</b>	25X47X10	MERLONI ARISTON	GP
<b>124.13.02</b>	21X40X7	ARDO MERLONI	GP
<b>124.13.03</b>	35X62X10	ARDO MERLONI	GP
<b>124.15.00</b>	30X54/63X11/15	BAUKNECHT	GPF
<b>124.15.01</b>	35X74/81X11/15	BAUKNECHT	GPF
<b>124.15.03</b>	40X74X80X14,5	BAUKNECHT	GPF
<b>124.16.00</b>	30X62/75X10/16	BLOMBERG	G2FS
<b>124.17.00</b>	28X52X10	SIEMENS-BOSCH	GP
<b>124.17.01</b>	32X52X10/12	SILTAL	GP
<b>124.17.02</b>	40X62/78X10,2X15,5	SIEMENS-BOSCH	GPF
<b>124.17.03</b>	25X42/59X10,2/15,5	SIEMENS-BOSCH	GPF
<b>124.17.04</b>	6X28/54,5X10,2	SIEMENS-BOSCH	
<b>124.17.05</b>	40X62/78X8/14,8	SIEMENS-BOSCH	GPPFIFE
<b>124.17.06</b>	28X52X9X11,5	SIEMENS-BOSCH	GPF
<b>124.17.07</b>	45X72/86X8/12	SIEMENS-BOSCH	GPF

ELEKTROLUKS