



SWITCHES 3

LIMIT SWITCHES

S

Switches 3

Micro switches



Position switches



Magnetic switches



GEV Großküchen-Ersatzteil-Vertrieb GmbH
Robert-Koch-Straße 3a
82152 Planegg/Munich
Germany

Phone: +49 (0)89 745572-0
Fax: +49 (0)89 745572-83
order@gev-online.com
www.gev-online.com

Member of the GEV GROUP

Micro switches TYPE A



page 4

Micro switches TYPE B



page 4

Micro switches TYPE C



page 6

Micro switches TYPE D and TYPE E



page 7

Special application microswitches



page 7

Float switches



page 8

Position switches



page 9

Magnetic switches round

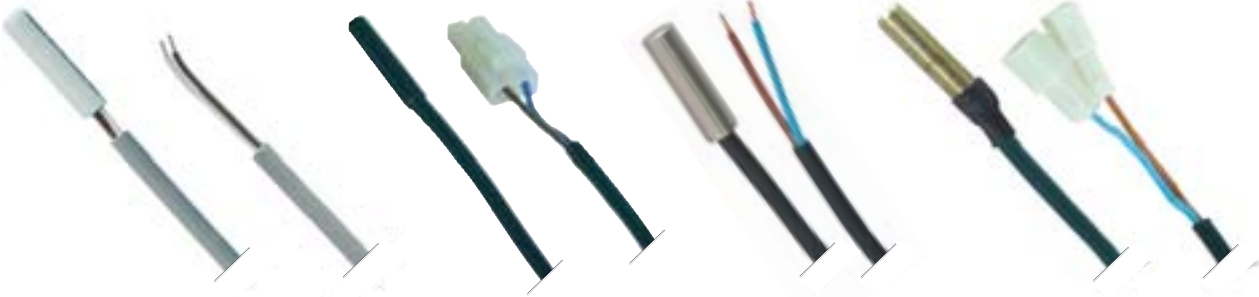

page 11

Magnetic switches flat



page 11

Magnets



page 14

Float, inductive and photoelectric switches



page 15

micro switches TYPE A micro switch universal



item	order no.	function	switch power	connection
1	345214	1CO	6A/250V	cable 500mm
2	345229	lever set	-	-
3	347006	1NO	10A/250V	cable 700mm



item	order no.	function	switch power	connection
1	346141	1NO	10A/250V	faston 2,8mm
2	346137	1CO	10A/250V	soldering
3	347026	1CO	5A/250V	soldering
4	347021	1CO	3A/250V	soldering

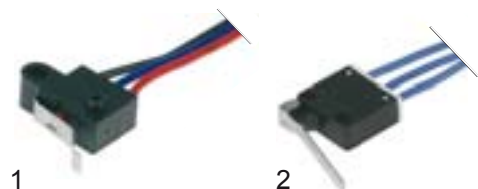

item	order no.	function	switch power	suitable for	ref. no.
1	347034	1NO	-	Henkelmann	0900465
1	347035	1CO	-	Henkelmann	0900466
2	347032	1NO	10A/250V	Henkelmann	0900460
2	347033	1CO	10A/250V	Henkelmann	0900461

micro switches TYPE B micro switches with lever



pos.	order no.	l(mm)	function	switch power	connection (mm)
1	345256	26,5	1CO	16A/250V	faston 6,3
2	345257	31,5	1CO	16A/250V	faston 6,3
3	346456	36	1CO	0,1A/250V	faston 6,3
4	345255	36	1CO	16A/250V	faston 6,3
5	347010	36	1CO	16A/250V	faston 4,8
6	346969	50	1NO	16A/250V	faston 6,3
7	345742	56	1CO	16A/250V	faston 6,3
8	346872	58	1CO	0,1A/250V	faston 6,3
9	345773	60	1CO	16A/250V	faston 6,3
10	345254	66	1CO	16A/250V	faston 6,3
11	345345	69	1CO	16A/250V	faston 6,3
12	346072	71	1CO	6A/250V	faston 6,3
13	345107	78/82/89	1CO	16A/250V	faston 6,3

micro switches with roller lever

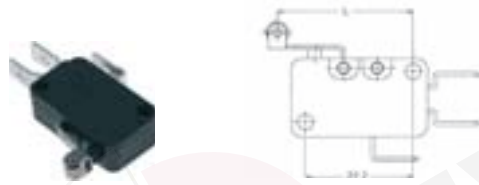

pos.	order no.	l(mm)	function	switch power	connection (mm)
1	345041	20,5	1CO	16A/250V	faston 6,3
2	345252	25	1CO	16A/250V	faston 6,3
3	345253	30	1CO	16A/250V	faston 6,3
4	345250	34,5	1CO	16A/250V	faston 6,3
5	345251	41	1CO	16A/250V	faston 6,3

micro switches universal



item	order no.	function	switch power	connection
1	345042	1CO	16A/250V	faston 6,3mm
2	300158	1CO	8A/250V	cable 1500mm
3	345043	lever set	-	-

basic button switches



item	order no.	function	switch power	connection (mm)
1	345105	1CO	16A/250V	faston 6,3mm
2	346158	1CO	5A/250V	faston 4,8mm
3	346145	1CO	10A/250V	faston 4,8mm
4	347043	1NC	16A/250V	faston 4,8mm

micro switches with special levers

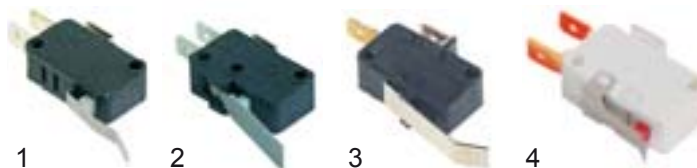

item	order no.	function	connection (mm)	suitable for	ref. no.
1	345059	1CO	faston 6,3	Comenda	120323
2	345178	1CO	faston 6,3	Elframo	25190003
3	346333	1NO	faston 6,3	Lotus	537025300
4	346159	1CO	faston 6,3	Rancilio	34100004



item	order no.	function	connection (mm)	suitable for	ref. no.
1	345363	1CO	faston 6,3	Faber	1035
2	345699	1NO	faston 6,3	Roller Grill	A07017
3	345791	1CO	faston 6,3	Gastrofrit	306.040.045

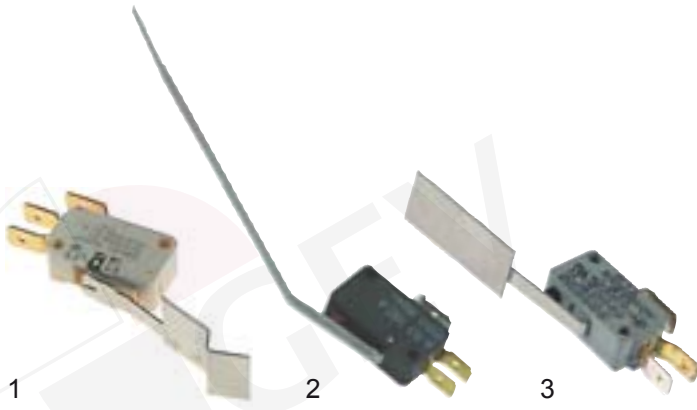

item	order no.	function	connection (mm)	suitable for	ref. no.
1	346314	1CO	faston 6,3	Tecnoeka	9951727000
2	345279	1CO	faston 6,3	ITV	100388
3	300152	1CO	faston 6,3	Gico	784106510



item	order no.	function	connection (mm)	suitable for	ref. no.
1	345368	1CO	faston 6,3	Staff	90/82010000
2	346152	1CO	faston 6,3	Mazzer	S00SMIA04
3	345367	1CO	faston 6,3	Staff	10318000

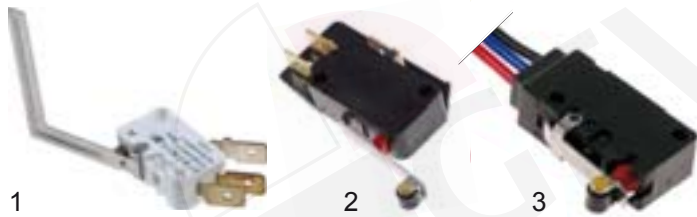

item	order no.	function	connection (mm)	suitable for	ref. no.
1	345515	1CO	faston 6,3	IME Omniwash	CEMP12CL
2	346876	1CO	faston 6,3	Icematic	19410208
3	347008	1CO	cable	Electrolux	0E5629

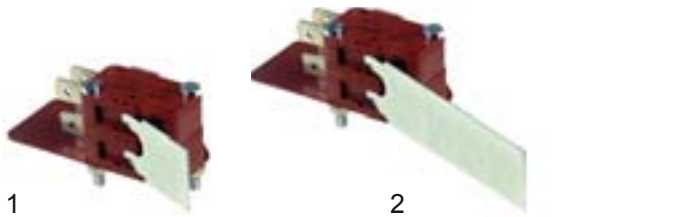

item	order no.	function	connection (mm)	suitable for	ref. no.
1	346838	2CO	faston 6,3	SMEG	814490215
2	346861	2CO	faston 6,3	SMEG	814490182



item	order no.	function	connection (mm)	suitable for	ref. no.
1	345580	2NO	faston 6,3	Elettrobar	218010
2	346927	2CO	faston 6,3	Adler	20035

micro switches with front fixing



item	order no.	fixing	function	switch power	connection (mm)
1	100010	M10x0,75mm	1CO	5A/250V	faston 6,3
2	100038	M11x1mm	1CO	5A/250V	faston 6,3
3	345425	M10x0,75mm	1CO	16A/250V	faston 6,3



item	order no.	fixing	function	switch power	connection (mm)
1	345032	M10x0,75mm	1CO	16A/250V	faston 6,3
2	345350	M11x1mm	1CO	16A/250V	faston 6,3



item	order no.	fixing	function	switch power	connection (mm)
1	346369	M10x0,75mm	1CO	16A/250V	faston 6,3
2	345104	M10x0,75mm Rollstößel	1CO	16A/250V	faston 6,3

special application microswitches



item	order no.	function	suitable for	ref. no.
1	346387	1NO	Zanussi	56944
2	346274	1CO	Ambach	5060917629
3	346290	1CO	Juno	245474

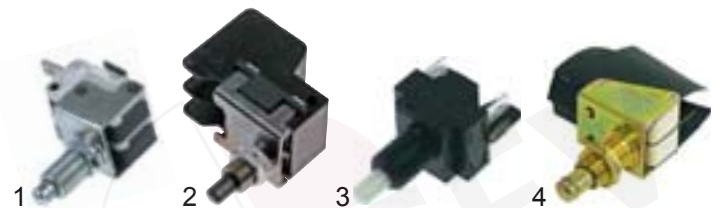

item	order no.	fixing	function	switch power	connection (mm)
1	347054	M10x0,75mm	2NO	16A/250V	faston 6,3
2	346347	M10x0,75mm	2NO	16A/250V	faston 6,3
3	300126	M11x1mm	2NO	16A/250V	faston 6,3
4	345048	M12x1mm	2CO	16A/250V	faston 6,3

micro switches TYPE C micro switches with lever

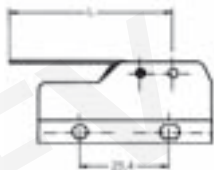

pos.	order no.	l(mm)	function	switch power
1	345268	38	1CO	16A/250V
2	345269	54	1CO	16A/250V
3	345125	63,5	1CO	16A/250V
4	345044	72	1CO	16A/250V
5	345270	133	1CO	16A/250V
6	345074	146,5	1CO	16A/250V
7	345271	152,5	1CO	16A/250V
8	346908	172	1CO	16A/250V



item	order no.	l(mm)	function	switch power
1	345121	73	1CO	16A/250V
2	346875	120	1CO	16A/250V



pos.	order no.	function	switch power
1	347051	1CO	16A/250V

micro switches with roller lever

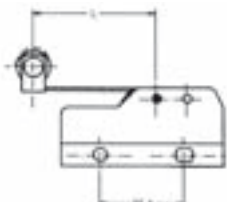

Pos	order no.	l(mm)	function	switch power
1	346874	25	1CO	16A/250V
2	345266	34,5	1CO	16A/250V
3	345045	50,5	1CO	16A/250V
4	345267	60	1CO	16A/250V

micro switches with front fixing



item	order no.	fixing	function	switch power
1	345156	M10x1mm	1CO	16A/250V
2	345138	M12x1mm	1CO	16A/250V
3	345258	M12x1mm	1CO	16A/400V



item	order no.	fixing	function	switch power
1	345679	M12x1mm	1CO	16A/250V
2	346370	M12x1mm	1CO	16A/250V
3	347009	M12x1mm	1CO	20A/250V

micro switches special types



item	order no.	function	switch power	suitable for	ref. no.
1	346878	1CO	16A/250V	Brema	23373
2	345103	1CO	20A/400V	San Marco	



item	order no.	description	function	switch power
1	345052	lever 53mm	1CO	10A/250V
2	345360	M12x1	1CO	10A/250V



item	order no.	function	suitable for	ref. no.
1	346574	1CO	Juno	247396
2	346507	1CO	Küppersbusch	177161



item	order no.	function	suitable for	ref. no.
1	345046	1NO+1NC	Eloma	VO600
2	345047	1CO	Rational	30161400
3	346289	1CO	Juno Electrolux	245481

micro switches TYPE D



item	order no.	function	switch power
1	345060	NO	16A/250V
2	345061	INC	16A/250V
3	345062	INO+INC	16A/250V



item	order no.	function	switch power
1	345247	2NO	16A/250V
2	345326	1NO	16A/250V
3	305004	1NO+1NC	16A/250V
3	347050	1NC	16A/250V

micro switches TYPE E

micro switches with snap-on mounting



item	order no.	description	function	switch power
1	345285	1-pole	2NO	16A/250V
2	300092	1-pole	2NO	16A/250V
3	345127	3-pole	3NO	16A/250V

special application microswitches

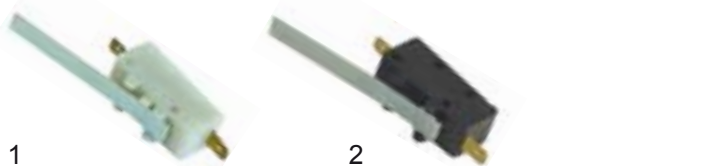

item	order no.	function	suitable for	ref. no.
1	345735	1NO	STAR10	73002
2	345736	1NC	STAR10	73011



item	order no.	function	suitable for	ref. no.
1	346904	1NO	Angelo Po	32W3700
2	345459	1NO	A.T.A.	7607
3	345460	1NO	A.T.A.	7620



item	order no.	function	suitable for	ref. no.
1	346909	1CO	Angelo Po	32W0010
2	346907	1CO	Angelo Po	32W0020
3	345585	1NO	Elettrobar	218003



item	order no.	function	suitable for	ref. no.
1	345186	1CO	Elframo	25190001
2	345815	1NO	Zanussi	60722
3	347007	1NC	Zanussi	046322

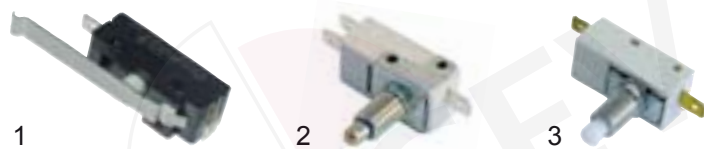

item	order no.	function	suitable for	ref. no.
1	346887	1NC	Scotsman	1200205901
2	345427	1CO	Fagor OEM	X343015 EG00100
3	345224	1NO	Honved	25552



item	order no.	function	suitable for	ref. no.
1	346865	1NO+1NC	CAB	1061/UL
2	345361	1NO+1NC	Icematic	1940205
3	345902	1NO+1NC	Bourgeois	INT103

micro switches with special mounting bracket



item	order no.	function	connection (mm)	suitable for	ref. no.
1	345992	1CO	faston 6,3	Winterhalter	62001349
2	345966	1CO	faston 6,3	Winterhalter	5519007

float switches



item	order no.	description	suitable for	ref. no.
1	345365	switch complete	Icematic	81449091
2	345373	switch complete	BREMA	C26562
3	345042	switch		

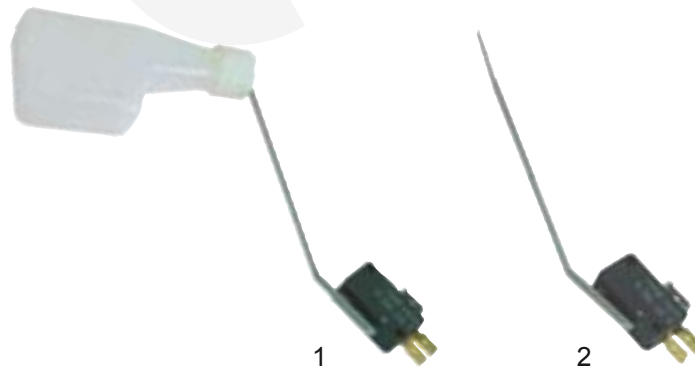

item	order no.	description	suitable for	ref. no.
1	345324	switch complete	I.T.V.	105058
2	345279	switch	I.T.V.	100388



item	order no.	description	suitable for	ref. no.
1	345372	switch complete	Eurfrigor	RH000830
2	345367	switch	Eurfrigor	
3	695044	float	Eurfrigor	RH000679

switches with snap-on mounting



item	order no.	mounting (mm)	function	switch power	faston (mm)
1	345249	26x12	1NO	65W/250V	6,3
2	346569	26x13	1NO	25W/250V	6,3
3	346772	27x20	1CO	2,5A/250V	4,8



item	order no.	mounting (mm)	function	switch power	faston (mm)
1	346139	27x13,5	1CO	13A/250V	6,3
2	346166	27x13,6	1NC	10A/250V	4,8
3	347018	26x12	1CO	1A/250V	2,8

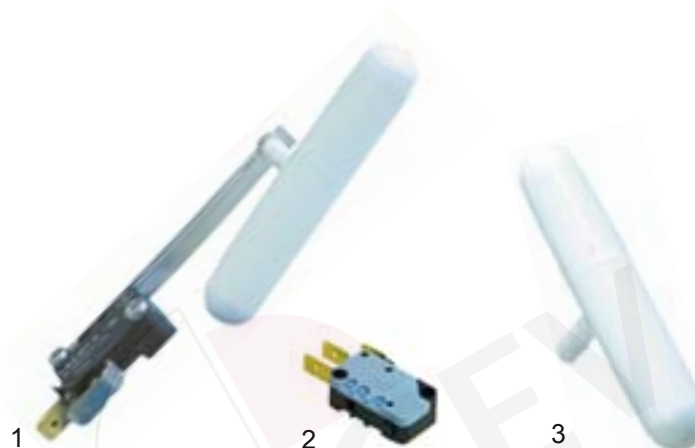

item	order no.	description	suitable for	ref. no.
1	345371	switch complete	Eurfrigor	RH00A310
2	345042	switch	Eurfrigor	
3	695044	float	Eurfrigor	RH000679

position switches

position switches Siemens

plastic housing IP65

base switch for use with actuators



pos.	order no.	description	function
1	346604	extended plunger	1NO+1NC
2	346605	extended plunger	2NO
3	346606	extended plunger	2NC

actuators



item	order no.	description	item	order no.	description
1	346607	roller plunger	3	346609	angled lever roller
2	346608	lever roller	4	346610	rotating lever roller



item	order no.	description	item	order no.	description
1	346611	adjustable rotating lever roller	3	346614	roller plunger with central mounting M18x1
2	346613	extended plunger with central mounting M18x1	4	346612	rod actuator

position switches Siemens

metal housing IP65



pos.	order no.	description	function
1	346288	lever roller	1NO+1NC

position switches Möller

plastic housing IP65

front fixing - not suitable for separate actuators



pos.	order no.	description	function
1	347016	extended plunger	1NO+1NC
2	345549	extended plunger	2NO
3	347017	extended plunger	2NC

base switch usable with actuators



pos.	order no.	description	function
1	346284	extended plunger	1NO+1NC
2	346987	extended plunger	2NO
3	346988	extended plunger	2NC

actuators



item	order no.	description	item	order no.	description
1	346989	roller plunger	3	346991	angled lever roller
2	346990	lever roller	4	346992	rotating lever roller

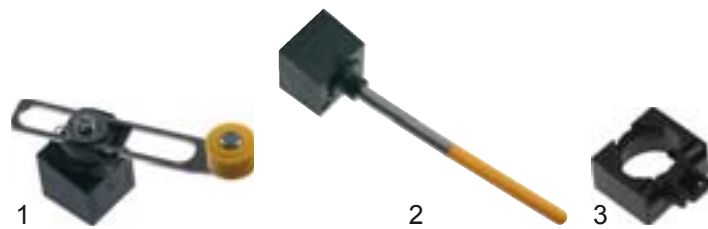

item	order no.	description	item	order no.	description
1	346993	adjustable lever roller	3	346995	mounting adaptor
2	346994	rod actuator			

Switches 3

©GEV 2008

position switches Pizzato

series FR

plastic housing IP67



item	order no.	description	function
1	345181	extended plunger	INO+INC
2	345337	extended plunger with gasket	INO+INC
3	345338	roller plunger	INO+INC



item	order no.	description	function
1	345389	lever roller	INO+INC
2	345144	rotating lever roller	INO+INC
3	345209	angled lever roller	INO+INC



item	order no.	description	function
1	345487	plunger button mounting M12x1	INO+INC
2	345488	plunger button mounting M18x1	INO+INC
3	345508	roller plunger mounting M18x1	INO+INC



item	order no.	description	function
1	345509	adjustable rotating lever roller	INO+INC
2	345513	rod actuator	INO+INC
3	347052	key	INO+INC

series FB

metal housing IP67



pos.	order no.	description	function
1	346175	roller plunger	INO+INC

series FD

metal housing IP67



item	order no.	description	function
1	345058	extended plunger with gasket	INO+INC
2	345862	lever roller	INO+INC



item	order no.	description	function
1	345057	rotating lever roller	INO+INC
2	345075	bar lever	INO+INC

series FA

metal housing IP67



item	order no.	description	function
1	300137	roller plunger	INO+INC
2	345696	roller plunger with front fixing M12x1	INO+INC
3	345697	rotating lever roller	INO+INC

position switches Bernstein



item	order no.	description	function	kind of protection.
1	345922	extended plunger	INO+INC	IP30
2	346296	lever roller	INO+INC	IP65
3	345921*	roller plunger	INO+INC	IP65

*metal housing IP67

position switches diverse



item	order no.	description	function	product
1	345040	rotating lever roller	INO+INC	Crouzet
2	347053	key	INO+INC	Lovato

magnetic switches round plastic 4x19mm



pos.	order no.	function	limiting values	cable (mm)
1	347049	1NO	-	1250

plastic 5,75x25mm type MK3



pos.	order no.	function	limiting values	cable (mm)
1	345967	1NO	0,5A/200V/10W	2000

plastic 6x29mm type A061



item	order no.	function	limiting values	cable (mm)
1	345146	1NO	1A/250V/50W	1000
2	345202	1NO	0,04A/250V/10W	1500
3	345819	1NO	1A/250V/50W	300

metal 8x58mm

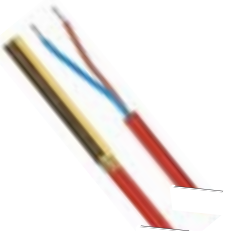

pos.	order no.	function	cable (mm)	suitable for	ref. no.
1	346511	1NO	2900	Rational	30161417

metal 9x31mm type B091



pos.	order no.	function	limiting values	cable (mm)
1	345991	1NO	1A/250V/50W	2000
2	345429	1NO	0,04A/250V/10W	2000

metal M8x0,75mm type D081



pos.	order no.	function	limiting values	cable (mm)
1	345631	1NO	1A/250V/50W	2000

metal M10x0,75mm type D102



pos.	order no.	function	limiting values	cable (mm)
1	345632	1NO	1A/250V/50W	2000

metal M12x1mm type D121



pos.	order no.	function	limiting values	cable (mm)
1	345430	1NO	1A/250V/50W	2000

metal M12x1mm type D122



pos.	order no.	function	limiting values	cable (mm)
1	345135	1NO	1A/250V/50W	2000

magnetic switch flat 32x15mm type MK12



pos.	order no.	function	limiting values	cable (mm)
1	345109	1NO (1A84)	0,5A/400V/10W	2000

32x15mm type MK12



pos.	order no.	function	limiting values	cable (mm)
1	345968	1NO (1A71)	0,5A/200V/10W	2000
2	345969	1NO (1A84)	0,5A/400V/10W	2000

23x14mm type MK4



pos.	order no.	function	limiting values	cable (mm)
1	346106	1NO	0,5A/90V/5W	500

28,5x19mm type 59135

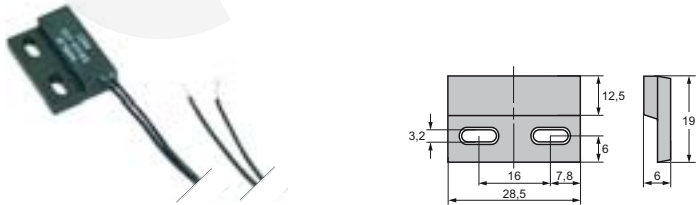

pos.	order no.	function	limiting values	cable (mm)
1	345219	1NO	0,5A/250V/10W	800
2	345248	1NO	0,5A/250V/10W	300

25x14mm type E540



pos.	order no.	function	limiting values	cable (mm)
1	345217	1NO	0,5A/200V/10W	2000

29x19mm type E560



pos.	order no.	function	limiting values	cable (mm)
1	345117	1NO	0,04A/250V/10W	1000
2	345808	1CO	0,5A/175V/10W	1000
3	345802	1NO	0,04A/250V/10W	5000

28,6x18mm type MA11



pos.	order no.	function	limiting values	cable (mm)
1	345807	1NO	0,5A/250V/10W	

38,8x25,5mm type MA45

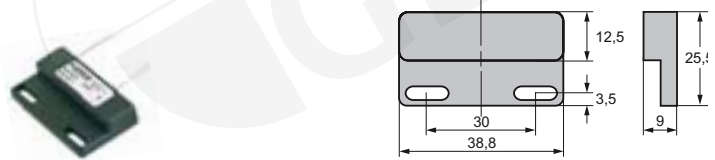

pos.	order no.	function	limiting values	cable (mm)
1	345804	1NO	0,5A/250V/10W	

36x13mm type E510



pos.	order no.	function	limiting values	cable (mm)
1	345118	1NO	0,5A/250V/50W	1000

36x13mm type E511

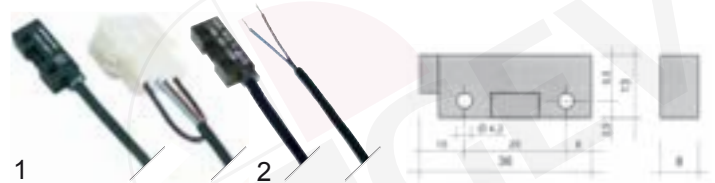

item	order no.	function	limiting values	cable (mm)
1	345820	1NO	0,5A/250V/50W	300
2	345792	1NO	0,04A/250V/10W	2000

37x16mm type E550

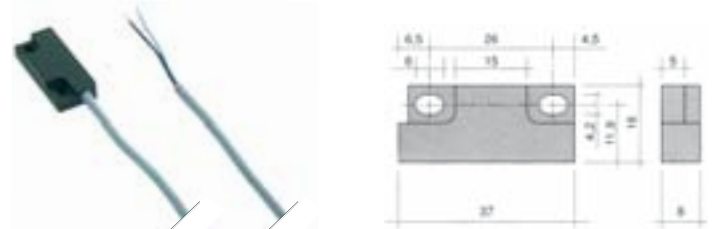

pos.	order no.	function	limiting values	cable (mm)
1	345341	1NO	0,04A/250V/10W	2000
2	345600	1NO	0,5A/250V/50W	1000

40x13mm type E521



pos.	order no.	function	limiting values	cable (mm)
1	345358	1NO	0,04A/250V/10W	2000

40x13mm type E522



pos.	order no.	function	limiting values	cable (mm)
1	345504	1NO	0,04A/250V/10W	2000

40x13mm type E520



pos.	order no.	function	limiting values	cable (mm)
1	345990	1NO	0,04A/250V/10W	2000

65x20mm type E530



pos.	order no.	function	limiting values	cable (mm)
1	345116	1NO	0,4A/250V/100W	3000
2	345122	1NO	8A/24V	340
3	346058	1NO	0,4A/250V/100W	90

80x15mm



pos.	order no.	function	limiting values	cable (mm)
1	345210	1NO	0,5A/265V/10W	600

76x21mm type E580

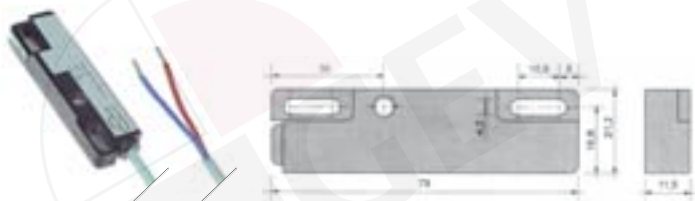

pos.	order no.	function	limiting values	cable (mm)
1	345783	1NO	1A/250V/50W	600

80x20mm type MA12



pos.	order no.	function	limiting values	cable (mm)
1	345803	1CO	1A/250V/80W	2000
2	345801	1NIO	3A/250V/100W	5000

flat 80x30mm type MA44



pos.	order no.	function	limiting values	cable (mm)
1	345919	1NO	3A/250V/100W	1250
2	345920	1NO	3A/250V/100W	1000
3	345918	1NO	0,2A/250V/100W	3500

80x30mm type MA44



pos.	order no.	function	limiting values	cable (mm)
1	345806	1CO	1A/250V/80W	6000

36x26mm type E590/E591



pos.	order no.	function	limiting values	cable (mm)
1	346998	1NO	3A/230V/60W	2000
2	347000	1NO	3A/230V/60W	5500
3	346999*	1NC	3A/230V/60W	2000

* polarized - type flat 35x22

35x22mm



pos.	order no.	function	limiting values	cable (mm)
1	347003	1NO	1A/230V/60W	1700

Switches 3

©GEV 2008

50x19mm type E710

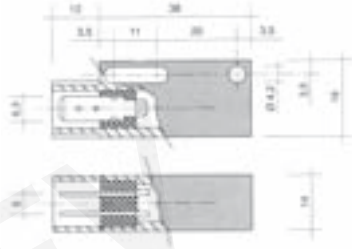

pos.	order no.	function	limiting values	connection (mm)
1	345821	1NO	1A/250V/50W	F6,3mm

magnets round



pos.	order no.	measures (mm)	pos.	order no.	measures (mm)
1	346891	ø6x13	4	346514	ø10x40
2	347002	ø6x30	5	346025	ø12x15
3	347047	ø10x3	6	347046	ø16x3

rectangular

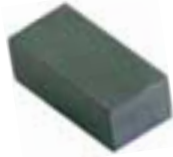

pos.	order no.	l x w x h (mm)	pos.	order no.	l x w x h (mm)
1	347045	5x12x24	2	345110	9x15x25

circular



pos.	order no.	measures (mm)	internal (mm)	pos.	order no.	measures (mm)	internal (mm)
1	345486	ø20x6	ø3,2	2	347048	ø32,5x6	ø18

type flat 25x14mm type M305

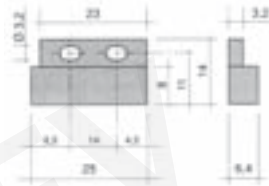

pos.	order no.	measures (mm)
1	345432	25x14

flat 24x16mm

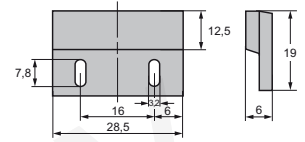

pos.	order no.	measures (mm)
1	345700	29x16

flat 29x16mm type M304

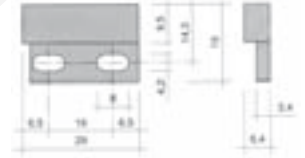

pos.	order no.	measures (mm)
1	345517	29x16

flat 36x13mm type M302

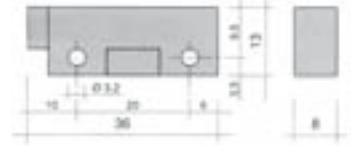

pos.	order no.	measures (mm)
1	345398	36x14

flat 37x16mm type M306

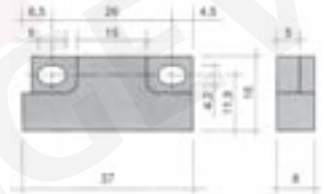

pos.	order no.	measures (mm)
1	345516	37x16

flat 40x13mm type M303

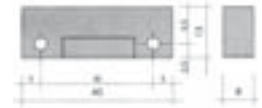

pos.	order no.	measures (mm)
1	345399	40x13

flat 45,5x18mm type M370



pos.	order no.	measures (mm)
1	345518	45,5x18

flat 63x18mm type M340

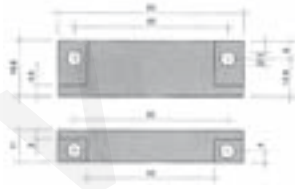

pos.	order no.	measures (mm)
1	345336	63x18

flat 63x18 type M350

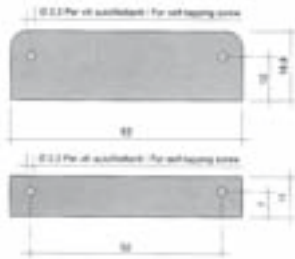

pos.	order no.	measures (mm)
1	519049	63x18

flat 76x23mm type M380

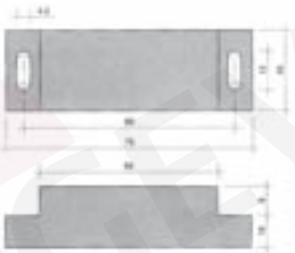

pos.	order no.	measures (mm)
1	345519	76x25

flat 88x25mm type M395

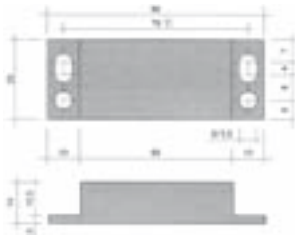

pos.	order no.	measures (mm)
1	345535	88x25

flat 23x15mm M375



pos.	order no.	measures (mm)
1	347001	23x15

float switches float switch type A (mounting \varnothing 15mm)

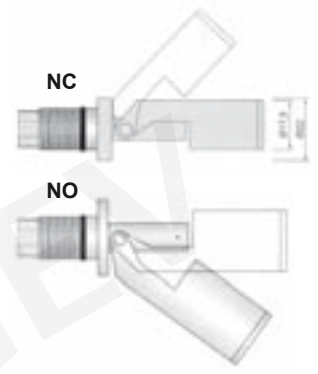

pos.	order no.	function	limiting values	connection (mm)
1	345446	1NO or 1NC	0,13A/250V/32W	250

float switch type B (mounting \varnothing 16mm)

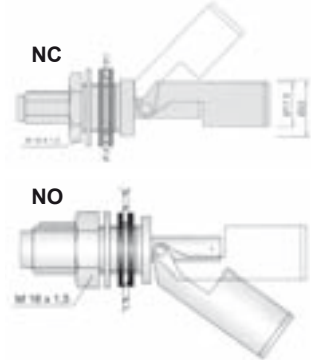

pos.	order no.	function	limiting values	connection (mm)
1	345484	1NO or 1NC	1A/250V/50W	2000

float switch type C (mounting \varnothing 22mm)

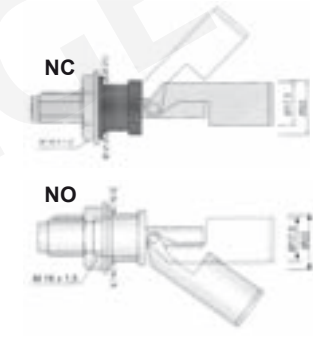

pos.	order no.	function	limiting values	cable (mm)
1	345822	1NO or 1NC	1A/250V/50W	2000

float switch type D (mounting \varnothing 22mm)

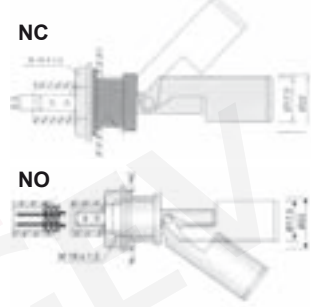

pos.	order no.	function	limiting values	connection (mm) (mm)
1	345447	1NO or 1NC	1A/250V/50W	faston 6,3

float switches type E (mounting $\varnothing 22\text{mm}$)

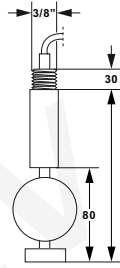

pos.	order no.	function	limiting values	cable (mm)
1	400023	1CO	0,5A/230V/10W	1800



pos.	order no.	function	suitable for	ref. no.
1	347042	1NO	Henkelmann	0220114



pos.	order no.	function	limiting values	cable (mm)
1	401986	1NO	1A/220V/60W	330



pos.	order no.	function	suitable for	ref. no.
1	402061	1NO	Hatco	802.01.249.00



pos.	order no.	function	limiting values	cable (mm)
1	401442	1NO	0,5A/250V/10W	2100

proximity switch (inductive)



pos.	order no.	mounting	function	limiting values	cable (mm)
1	345900	$\varnothing 12\text{mm}$	1NO	0,2A/24-240V	2000
2	345698	$\varnothing 12\text{mm}$	1NC	0,2A/24-240V	2000
3	346578	$\varnothing 18\text{mm}$	1NO	0,35A/20-250V	2000

photoelectric barriers



pos.	order no.	mounting	function	limiting values	suitable for
1	401970	$\varnothing 18\text{mm}$	1NO	0,1A/15-264V	Meiko

photoelectric barriers



item	order no.	suitable for	ref. no.
1	402043	Scotsman	65067402 78508602
2	402009	Scotsman	65067400

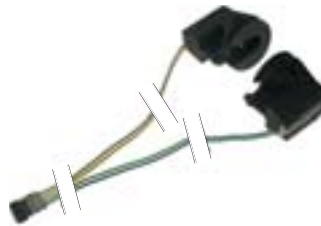

pos.	order no.	suitable for	ref. no.
1	402039	Scotsman	78508600 78508602R

