



# PREKIDAČI Pr



UNIVERZALNI PREKIDAČI  
UNIVERZALNI MINIJATURNI  
POTISNI PREKIDAČI  
KLIK-KLAK PREKIDAČI  
OKRUGLI PREKIDAČI  
KRUZNI OBRтни PREKIDAČI  
DIP PREKIDAČI  
KODNI PREKIDAČI  
METALNI PREKIDAČI  
KLIZECI PREKIDAČI  
MIKRO PREKIDAČI  
PREKIDAČI ZA AUTOMOBILE  
KONTAKT BRAVE  
MREZNI PREKIDAČI



# PREKIDAČI

PR

## UNIVERZALNI PREKIDAČI . . . . . PRU JEDNOPOLNI UNIVERZALNI PREKIDAČI . . . . . PRU1

**Tehnički podaci:**

Napon: 250V AC  
 Otpornost kontakta: < 100 mΩ / 12V DC, 1A  
 Otpornost izolacije: > 20 MΩ  
 Probajni napon kontakti otvoreni: > 1kV  
     između polova: > 3kV  
     pokretni delovi/metalni delovi: > 4kV  
 Temperatura okoline, max: +125°C  
 Vek trajanja, električni: > 10.000 uključivanja  
 Kontakti:

otporno opterećenje (250V AC): 16A  
 induktivno opterećenje (motori): 4A  
 ne induktivno opterećenje: 16A/250V AC  
 jednosmerna struja (28V DC): 20A  
 strujni pic 36A



Tip	Funkcija	Cena
UI	1 pol. uklj./isklj.	2,00

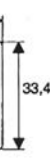
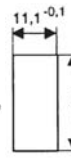
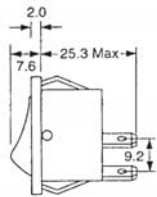

Tip	Funkcija	Cena
UITCR	1 pol. uklj./isklj.	3,00
UITZE	1 pol. uklj./isklj.	3,00

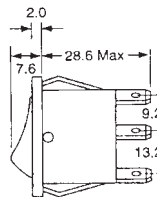

Tip	Funkcija	Cena
UI U	1 pol. uklj./uklj.	3,50

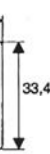
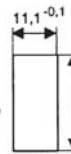
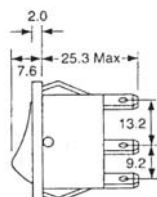



# PREKIDAČI

PR

UNIVERZALNI PREKIDAČI . . . . . PRU

DVOPOLNI UNIVERZALNI PREKIDAČI . . . . . PRU2

**Tehnički podaci:**

Napon:	250V AC
Otpornost kontakta:	< 100 mΩ / 12V DC, 1A
Otpornost izolacije:	> 20 MΩ
Probajni napon kontakti otvoreni:	> 1kV
između polova:	> 3kV
pokretni delovi/metalni delovi:	> 4kV
Temperatura okoline, max:	+125°C
Vek trajanja, električni:	> 10.000 uključivanja
Kontakti: otporno opterećenje (250V AC):	16
induktivno opterećenje (motori):	4A
ne induktivno opterećenje:	16A/250V AC
jednosmerna struja (28V DC):	20A
strujni pic	36A

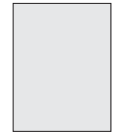

Tip	Funkcija	Cena
UICN	2 pol. uklj./isklj.	3,00
UISI	2 pol. uklj./isklj.	3,00

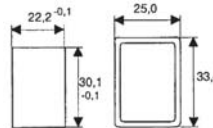
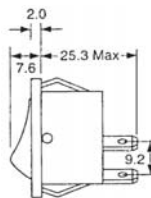

Tip	Funkcija	Cena
UITCR	2 pol. uklj./isklj.	3,50
UITZE	2 pol. uklj./isklj.	3,50

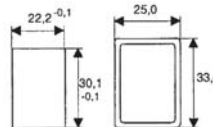
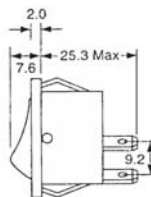
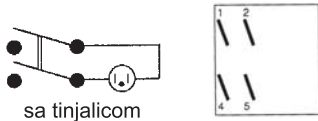

Tip	Funkcija	Cena
UIT2	2 pol. uklj./isklj.	4,00

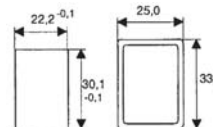
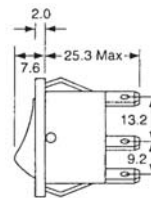
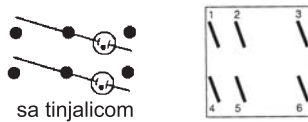

Tip	Funkcija	Cena
UU	2 pol. uklj./uklj.	5,00

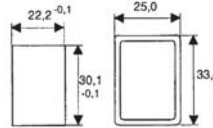
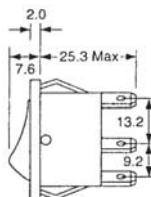
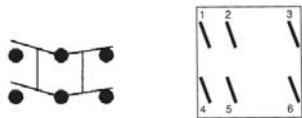



# PREKIDAČI

PR

## UNIVERZALNI MINIJATURNI PREKIDAČI . . . . . PRUM

### JEDNOPOLNI UNIVERZALNI MINIJATURNI PREKIDAČI . . . . . PRUM1

**Tehnički podaci:**

Napon:	250V AC
Otpornost kontakta:	< 100 mΩ / 12V DC, 1A
Otpornost izolacije:	> 20 MΩ
Probojni napon kontakti otvoreni:	> 1kV
između polova:	> 3kV
pokretni delovi/metalni delovi:	> 4kV
Temperatura okoline, max:	+125°C
Vek trajanja, električni:	> 10.000 uključivanja
Kontakti: otporno opterećenje (250V AC):	10A
induktivno opterećenje (motori):	6A
ne induktivno opterećenje:	15A/250V AC
jednosmerna struja (28V DC):	10A
strujni pic	25A



Tip	Funkcija	Cena
UICR	1 pol. uklj./isklj.	1,50
UICN	1 pol. uklj./isklj.	1,50

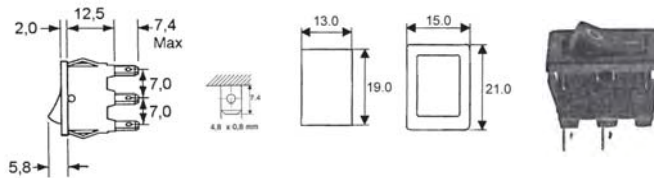

Tip	Funkcija	Cena
UITCR	1 pol. uklj./isklj.	3,00
UITZE	1 pol. uklj./isklj.	3,00



sa tinjalicom

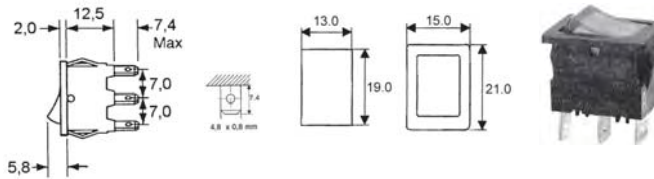

Tip	Funkcija	Cena
UU	1 pol. uklj./uklj.	3,00

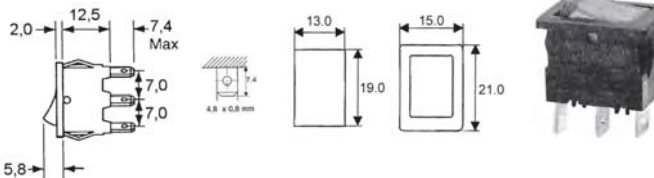

Tip	Funkcija	Cena
UIU	1 pol. uklj./isklj./uklj.	3,00

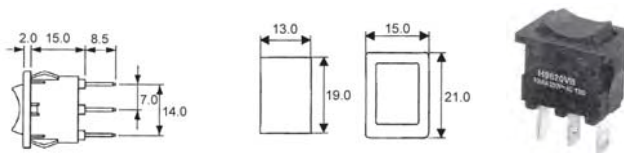



# PREKIDAČI

PR

UNIVERZALNI MINIJATURNI PREKIDAČI . . . . . PRUM

DVOPOLNI UNIVERZALNI MINIJATURNI PREKIDAČI . . . . . PRUM2

**Tehnički podaci:**

Napon:	250V AC
Otpornost kontakta:	< 100 mΩ / 12V DC, 1A
Otpornost izolacije:	> 20 MΩ
Probojni napon kontakti otvoreni:	> 1kV
između polova:	> 3kV
pokretni delovi/metalni delovi:	> 4kV
Temperatura okoline, max:	+125°C
Vek trajanja, električni:	> 10.000 uključivanja
Kontakti: otporno opterećenje (250V AC):	10A
induktivno opterećenje (motori):	6A
ne induktivno opterećenje:	15A/250V AC
jednosmerna struja (28V DC):	10A
strujni pic	25A

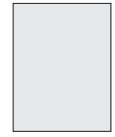

Tip	Funkcija	Cena
UI	2 pol. uklj./isklj.	4,00

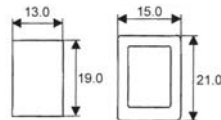
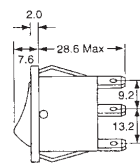

Tip	Funkcija	Cena
UITCR	2 pol. uklj./isklj.	5,00
UITZE	2 pol. uklj./isklj.	5,00

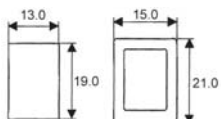
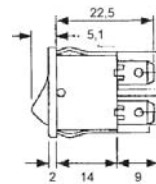
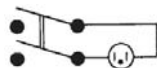

ZATITNA KAPA ZA MINIJATURNE PREKIDAČE . . . . . PRUMZK

Cena: 1,20

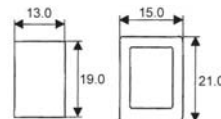



## PREKIDAČI

PR

POTISNI PREKIDAČI . . . . . PRP

POTISNI PRAVOUGAONI PREKIDAČI . . . . . PRPP

**Tehnički podaci:**  
 Snaga uključivanja max: 3A / 125 V AC  
 Otpornost kontakta: < 20 mΩ  
 Otpornost izolacije: 100 MΩ  
 Ispitni napon: 1500 V AC  
 Radni vek: >100 000 uključivanja

CR crveni  
 CN crni  
 PL plavi  
 ZE zeleni  
 ZU žuti



Cena: 1,50

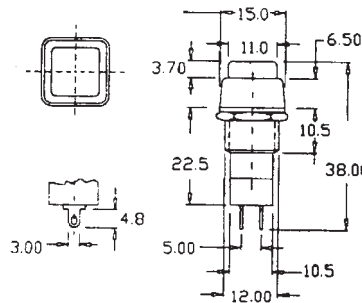

POTISNI OKRUGLI PREKIDAČI . . . . . PRPO

**Tehnički podaci:**  
 Snaga uključivanja max: 3A / 125 V AC  
 Otpornost kontakta: < 20 mΩ  
 Otpornost izolacije: 100 MΩ  
 Ispitni napon: 1500 V AC  
 Radni vek: >100 000 uključivanja

CR crveni  
 CN crni  
 PL plavi  
 ZE zeleni  
 ZU žuti

Cena: 1,50

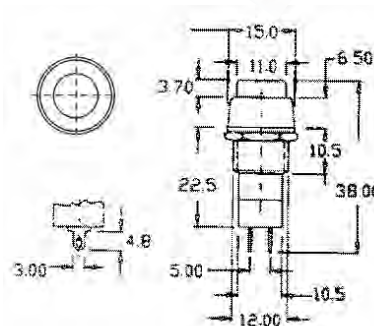



# PREKIDAČI

PR

## POTISNI PREKIDAČI . . . . . PRP

### POTISNI PREKIDAČI UNIVERZALNI . . . . . PRPU

**Tehnički podaci:**

Napon: 250V AC  
 Ispitni napon: 1500V AC  
 Otpornost kontakta: <math><100\text{m}\Omega</math> 12V DC 1A  
 Otpornost izolacije: 20M $\Omega$   
 Probajni napon: kontakti otvoreni: >1KV  
 između pinova: >3KV  
 Temperatura okoline: +105°C  
 Vek trajanja: >10000 uključivanja  
 Kontakti: otporno opterećenje(250V AC): 12A  
 induktivno opterećenje: 2A  
 ne induktivno opterećenje: 13A / 250V AC

Tip	Funkcija	Cena
CN	1 pol. uklj./isklj.	4,00
T	2 pol. uklj./isklj.	5,00

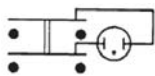

T sa tinjalicom



CN crni

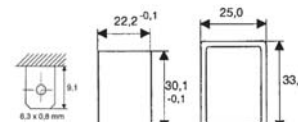
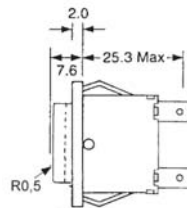
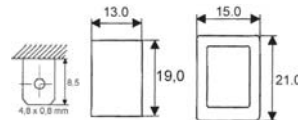
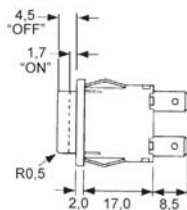

## POTISNI PREKIDAČI SA LED DIODOM . . . . . PRPL

**Tehnički podaci:**

Snaga uključivanja: 1,5A / 250V AC  
 Otpornost kontakta: <math><20\text{m}\Omega</math>  
 Otpornost izolacije: 10m $\Omega$   
 Ispitni napon: 1500V AC  
 Radni vek: >100000 uključivanja

Tip	Funkcija	Cena
CR	1 pol. uklj./isklj.	6,00
ZE	1 pol. uklj./isklj.	6,00



okrugli sa led diodom

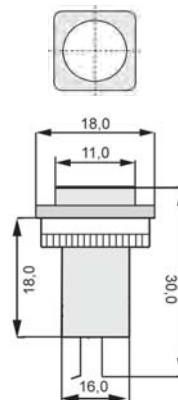



# PREKIDAČI

PR

**KLIK-KLAK PREKIDAČI. . . . . PRKK**

**KLIK-KLAK UNIVERZALNI PREKIDAČI . . . . . PRKKU**

**Tehnički podaci:**

Napon: 250V AC  
 Struja uključenja, max: 16A  
 Struja induktivnog opterećenja: 4A  
 Strujni pic: 36A  
 Temperatura okoline, max: +85°C

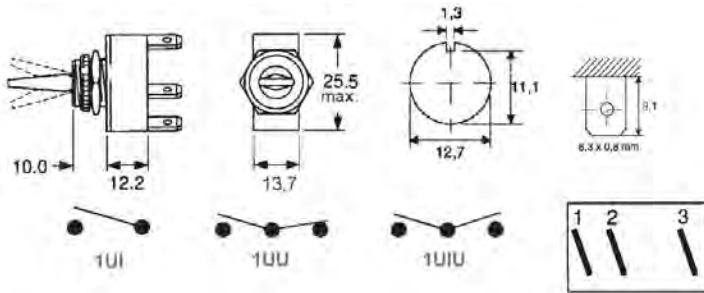

Tip	Funkcija	Cena
1UI	1 pol. 1 poloZaj uklj./isklj.	3,00
1UU	1 pol. 2 poloZaja uklj./isklj.	4,00
1UIU	1 pol. 3 poloZaja uklj./isklj./uklj.	5,00

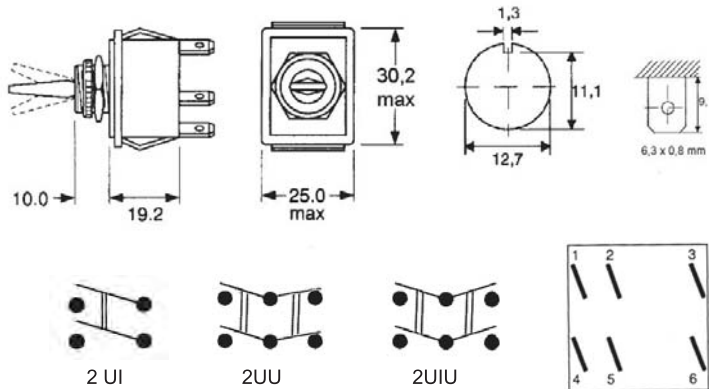

Tip	Funkcija	Cena
2UI	2 pol. 1 poloZaj uklj./isklj.	4,00
2UU	2 pol. 2 poloZaja uklj./isklj.	5,00
2UIU	2 pol. 3 poloZaja uklj./isklj./uklj.	6,00







# PREKIDAČI

PR

## KLIK-KLAK PREKIDAČI. . . . . PRKK

## KLIK-KLAK MINIJATURNII PREKIDAČI . . . . .PRKKM

**Tehnički podaci:**

Snaga uključivanja: 6A/125V AC, 3A/250V AC  
 Probojni napon: 500V AC / 1min  
 Otpornost provođenja: < 30 mΩ  
 Otpornost izolacije: ≥ 500 MΩ / 500V  
 Vek trajanja pod opterećenjem: 10.000 uključivanja  
 neopterećen: 15...18 uključ. / min  
 Temperaturni opseg: -30...+85°C

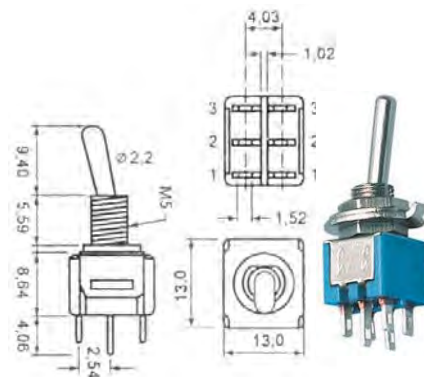
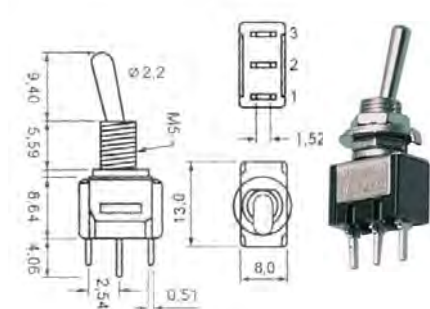
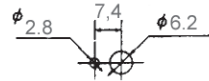

Tip	Funkcija	Cena
1UU	1 pol. 2 poloZaja uklj./uklj.	1,20
1UIU	1 pol. 3 poloZaja uklj./isklj./uklj.	1,50

Tip	Funkcija	Cena
2UU	2 pol. 2 poloZaja uklj./uklj.	1,50
2UIU	2 pol. 3 poloZaja uklj./isklj./uklj.	1,80

## KLIK-KLAK SUBMINIJATURNI PREKIDAČI . . . . . PRKKS

**Tehnički podaci:**

Snaga uključivanja: 3A/125V AC  
 Probojni napon: 1000V / 1min.  
 Otpornost provođenja: < 30 mΩ  
 Otpornost izolacije: 100 MΩ / 500V DC  
 Vek trajanja pod opterećenjem: 10.000 uključivanja  
 neopterećen: 15...18 uključ. / min  
 Temperaturni opseg: -30...+85°C

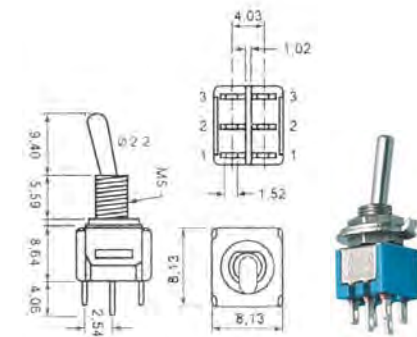
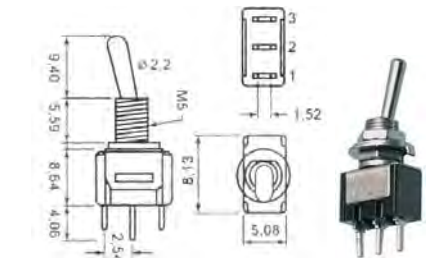
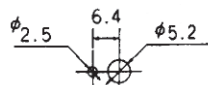

Tip	Funkcija	Cena
1UU	1 pol. 2 poloZaja uklj./uklj.	1,20

Tip	Funkcija	Cena
2UU	2 pol. 2 poloZaja uklj./uklj.	1,50



# PREKIDAČI

PR

## OKRUGLI PREKIDAČI . . . . . PRO

**Tehnički podaci:**

Snaga uključivanja: 6A, 250V AC / 10A, 125V AC  
 Vek trajanja, električni : 10.000 (6A 250VAC)  
 Otpornost provođenja (nov): < 50 MΩ  
 Otpornost izolacije (nov): > 100 MΩ / 500V  
 Probajni napon: 1500V AC / 1 min  
 Napon za LED, max: 2,5V / 20mA  
 Temperatura okoline: max 125°C

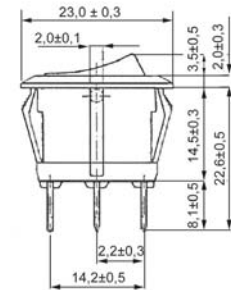
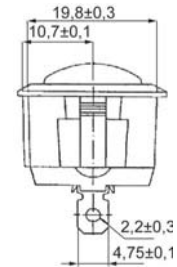

Tip	Funkcija	Cena
UI	uklj./isklj. crni	2,00

Tip	Funkcija	Cena
UIU	uklj./isklj./uklj.	2,50

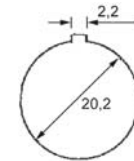

sa tinjalicom



sa led diodom



sa led diodom

Tip	Funkcija	Cena
TCR	uklj./isklj. crveni	3,00
TZE	uklj./isklj. zeleni	3,00

Tip	Funkcija	Cena
LCR	uklj./isklj. crveni	3,50
LZE	uklj./isklj. zeleni	3,50

Tip	Funkcija	Cena
PCR	uklj./isklj. crveni	4,00
PZE	uklj./isklj. zeleni	4,00



# PREKIDAČI

PR

## KRUZNI OBRтни PREKIDAČI. . . . . PRKO

**Tehnički podaci:**

Napon:	250V AC
Otpornost kontakta:	< 100 mΩ / 120V DC, 1A
Otpornost izolacije:	> 20 MΩ
Probojni napon kontakti otvoreni:	> 1kV
između polova:	> 3kV
pokretni delovi/metalni delovi:	> 4kV
Temperatura okoline, max:	+125°C
Vek trajanja, električni:	> 10.000 uključivanja



1x12



2x6



3x4



4x3

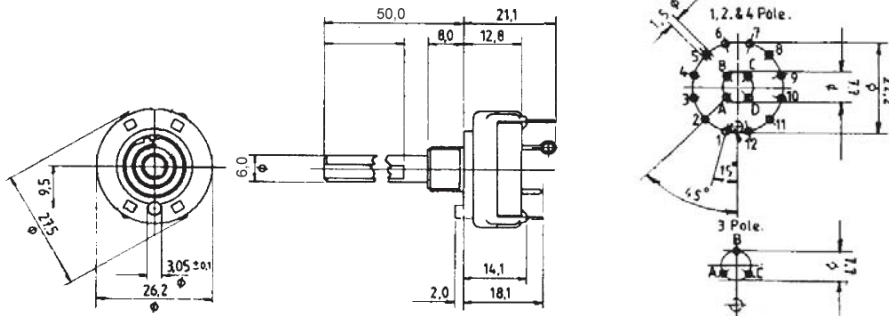

Tip	Cena	Broj polova	Broj poloZaja	Vrsta
1 x 12	5,00	1	12	za lemljenje provodnika
2 x 6	5,00	2	6	
3 x 4	5,00	3	4	
4 x 3	5,00	4	3	
2 x 2 x 12	12,00	2 x 2	12	za print montaZu
2 x 4 x 5	12,00	2 x 4	5	
2 x 6 x 4	12,00	2 x 6	4	
P 1 x 12	5,00	1	12	
P 2 x 6	5,00	2	6	za print montaZu
P 3 x 4	5,00	3	4	
P 4 x 3	5,00	4	3	



# PREKIDAČI

PR

## DIP PREKIDAČI . . . . . PRDIP

### Električni podaci:

Snaga uključivanja:	25mA / 24V DC
Provodna struja:	100mA / 50V DC
Otpornost kontakta, nov:	50mΩ
Napon testa veka trajanja:	100mΩ
Napon izolacije (100V DC), min:	1000MΩ
Napon proboja:	500V D / 1min
Kapacitet:	5pF



### Tehnički podaci:

NoŽice:	pocinkovane
Kontakti:	zlato preko nikla
Temperaturni opseg:	-25...+70°C
Snaga aktiviranja, max:	800g
Vek trajanja:	2000 aktiviranja
Temperatura lemljenja:	260 ±5 °C / 5 <sup>-1</sup> s
Raster:	2,54 mm

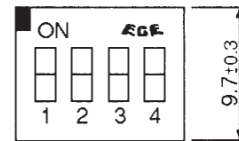

Tip	Cena	Pol	A (mm)
01	1,80	1	4,2
02	2,00	2	6,7
03	2,30	3	9,2
04	2,50	4	11,7
06	3,00	6	16,7
08	3,50	8	21,7
10	4,00	10	26,7

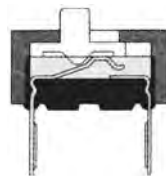
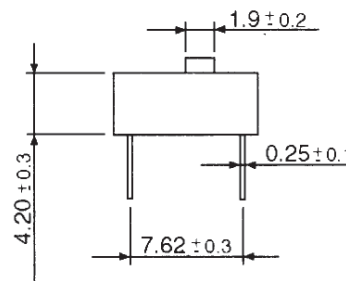
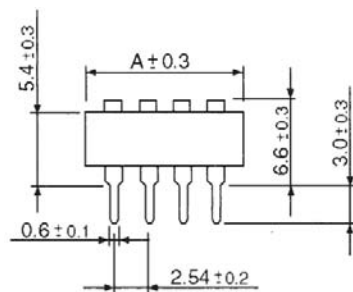
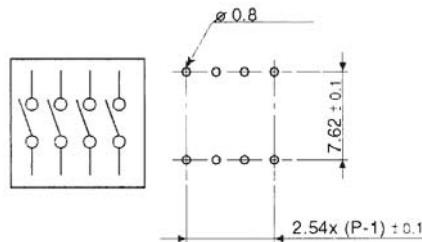



# PREKIDAČI

PR

## KODNI PREKIDAČI . . . . . PRKD

### Električni podaci:

Snaga uključivanja: 25mA / 24V DC  
 Provodna struja: 100mA / 50V DC  
 Otpornost kontakta, nov: 100mΩ  
 Otpornost izolacije (100V DC), min: 1000MΩ  
 Napon proboja: 250V D / 1min

### Tehnički podaci:

NoZice: pocinkovane  
 Kontakti: zlato preko nikla  
 Temperaturni opseg: -25...+70°C  
 Snaga aktiviranja, max: 800g/cm  
 Temperatura lemljenja: 260 ±5 °C / 5<sup>±1</sup> s  
 Raster: 2,54 mm

TIP1

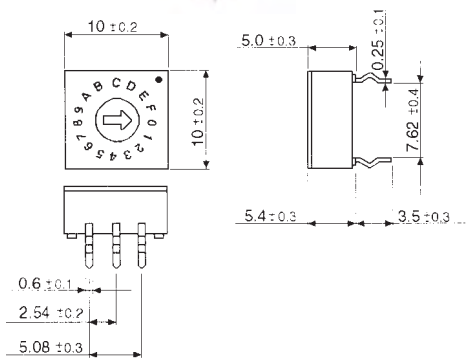

Tip	Cena	Pol	Kodiranje
10BR	5,00	10	bin.real.
10BK	5,00	10	bin.kompl.
16HR	5,00	16	hex.real.
16HK	5,00	16	hex.kompl.

TIP2

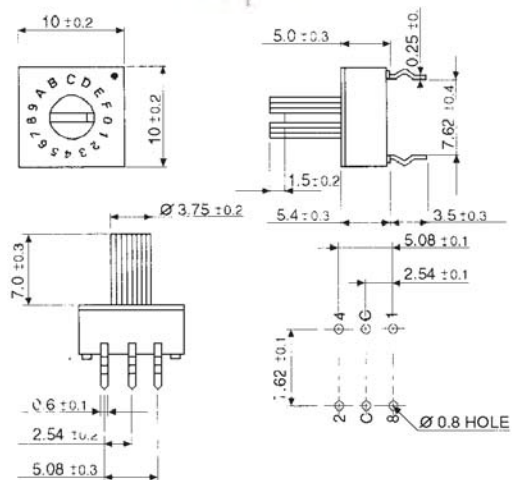

Tip	Cena	Pol	Kodiranje
10BR	6,00	10	bin.real.
16HR	6,00	16	hex.real.

## METALNI PREKIDAČI . . . . . PRMET

### Tehnički podaci:

Snaga uključivanja: 2A / 250V AC  
 Otpornost kontakta, nov: <50mΩ  
 Otpornost izolacije: 1000MΩ  
 Ispitni napon: 1500V eff  
 Radni vek: >100.000 uključivanja

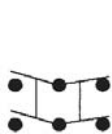

Cena: 6,00

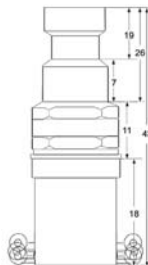
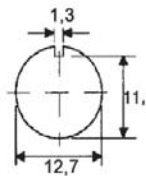
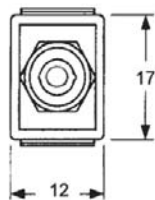



# PREKIDAČI

PR

## KLIZEĆI PREKIDAČI. . . . . PRKL

<p><b>01</b> 1,20</p>	<p><b>02</b> 1,60</p>	<p>25X7X8</p> <p><b>03</b> 1,60</p>
-----------------------	-----------------------	-------------------------------------

<p><b>04</b> 1,60</p>	<p>20X10X9</p> <p><b>05</b> 1,60</p>	<p><b>06</b> 1,20</p>
-----------------------	--------------------------------------	-----------------------

<p><b>07</b> 1,50</p>	<p>27X9,3X10,5</p> <p><b>08</b> 1,80</p>	<p><b>09</b> 1,50</p>
-----------------------	--	-----------------------



# PREKIDAČI

PR

## KLIZEĆI PREKIDAČI. . . . . PRKL

21 pin 7 poloZaja  
2 kontakta raster 2,50 mm  
10.....12,00

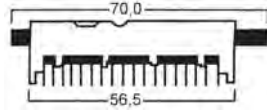

27 pina 9 poloZaja  
2 kontakta raster 2,00 mm  
11.....12,00

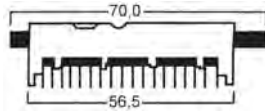

27 pina 9 poloZaja  
2 kontakta raster 2,50 mm  
12.....32,00

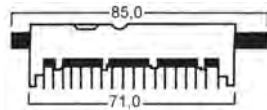

36 pina 12 poloZaja  
2 kontakta raster 2,00 mm  
13.....22,00

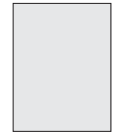
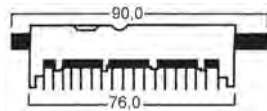

## MIKRO PREKIDAČI . . . . . PRMI

**Tehnički podaci:**

- Napon: 125-250V AC
- Struja uključenja: 3-5A
- Probojni napon: 1500V AC 1min.
- Vek trajanja: 100000 uključivanja
- Temperaturni opseg: -25...+85°C

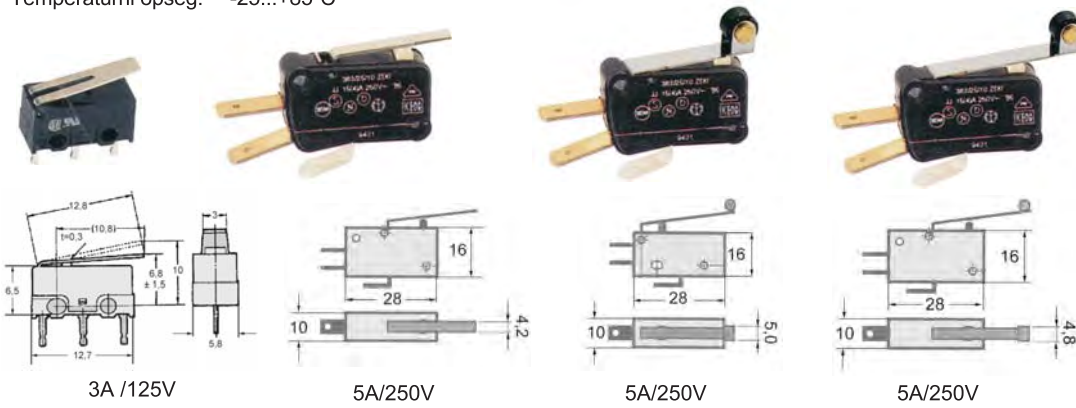

01.....2,50    02.....3,00    03.....3,00    04.....3,00



# PREKIDAČI

PR

## PREKIDAČI ZA AUTOMOBILE . . . . . PRA

**Tehnički podaci:**

Napon:	12V DC	Otpornost izolacije:	20MΩ
Struja uključenja:	20A	Napon sijalice:	12V DC
Strujni pic:	40A	Vek trajanja:	10.000 uključivanja
Otpornost kontakta:	100mΩ 12V DC 1A	Temperatura okoline:	+125°max

Tip	Funkcija	Cena
UCR	1 pol. uklj./isklj.	3,00
UZE	1 pol. uklj./isklj.	3,00



univerzalni sa sijalicom

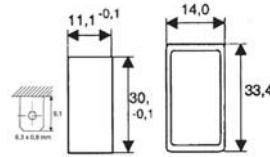
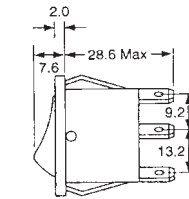

Tip	Funkcija	Cena
OCR	1 pol. uklj./isklj.	3,00
OZE	1 pol. uklj./isklj.	3,00



okrugli sa sijalicom

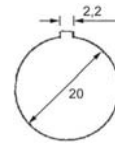
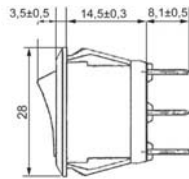

Tip	Funkcija	Cena
KK	1 pol. uklj./isklj.	4,00



klik-klak sa sijalicom

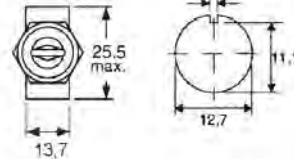
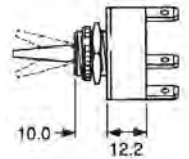

Tip	Funkcija	Cena
P	1 pol. uklj./isklj.	4,00



potezni

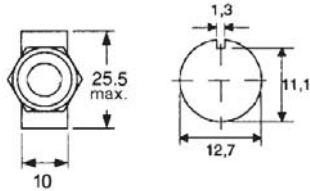
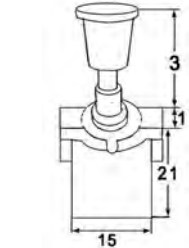

Tip	Funkcija	Cena
T	2 pol. uklj./isklj./uklj.	10,00



taster

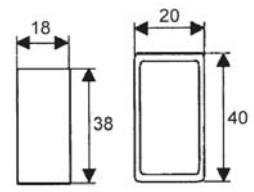
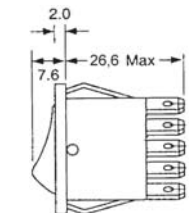





# PREKIDAČI

PR

KONTAKT BRAVE ..... PRBR

MINI-OKRUGLA ..... PRBRMO

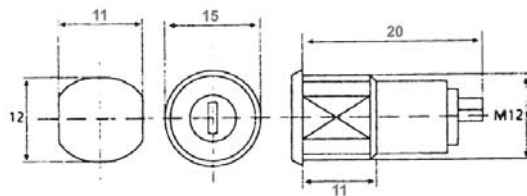

2 kontakta 120V/2A

Cena: 8,00

MINI - RAVNA ..... PRBRMR

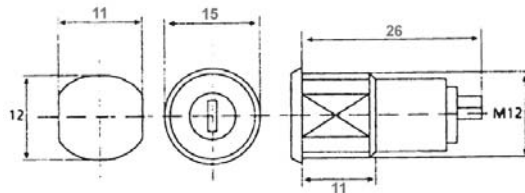

2 kontakta 120V/2A

Cena: 12,00

RAVNA ..... PRBRR

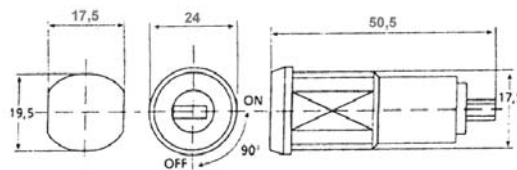

2 kontakta 150V/3A

Cena: 16,00













# PREKIDAČI

PR

## MREZNI PREKIDAČI . . . . . PRMR

<p>4/64A 250V Montaža 18mm 2,4 mm EI</p>  <p><b>01</b> 3,00</p>	<p>4/64A 250V Montaža 18 mmØ2,4 mm NORDMENDE</p>  <p><b>02</b> 6,00</p>	<p>4/100A 250V Montaža 25 mmØ3,5 mm GRUNDIG / ITT</p>  <p><b>03</b> 24,00</p>
--	--	--

<p>4/100A 250V Montaža 23 mmØ3,2 mm ITT / PHILIPS</p>  <p><b>04</b> 6,00</p>	<p>4/100A 250V Montaža 24 mmØ3,2 mm ITT / PHILIPS</p>  <p><b>05</b> 6,00</p>	<p>4/100A 250V Specijalna montaža TELEFUNKEN</p>  <p><b>06</b> 24,00</p>
---	---	---

<p>4/64A 250V Specijalna montaža PHILIPS</p>  <p><b>07</b> 28,00</p>	<p>4/100A 250V Montaža 23 mmØ3,2mm PHILIPS</p>  <p><b>08</b> 6,00</p>	<p>2,5/100A 250V Montaža - print TFK / PHILIPS</p>  <p><b>09</b> 6,00</p>
---	--	--





# PREKIDAČI

PR

## MREZNI PREKIDAČI . . . . . PRMR

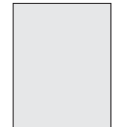
<p>2,5/100A 250V Montaža 18 mmØ2,4 mm NORDMENDE</p>  <p><b>10</b> 8,00</p>	<p>2,5/100A 250V Montaža 18 mmØ2,4 mm NORDMENDE / PREH</p>  <p><b>11</b> 10,00</p>	<p>2,5/100A 250V Montaža 36 mmØ3,2 mm GRUNDIG</p>  <p><b>12</b> 6,00</p>
---	---	---



<p>2,5/100A 250V Montaža 36 mmØ3,2 mm NORDMENDE</p>  <p><b>13</b> 19,00</p>	<p>2,5/100A 250V Specijalna montaža SIEMENS</p>  <p><b>14</b> 6,00</p>	<p>2,5/100A 250V Montaža 20 mm - print BLAUPUNKT</p>  <p><b>15</b> 6,00</p>
--	---	--



<p>2,5/100A 250V Montaža 20 mmØ2,4 mm GRUNDIG</p>  <p><b>16</b> 6,00</p>	<p>2,5/100A 250V Specijalna montaža ITT</p>  <p><b>17</b> 11,00</p>	<p>2,5/100A 250V Montaža 20 mm - print G.D.E.</p>  <p><b>18</b> 7,00</p>
---	--	---









# PREKIDAČI

PR

## MREZNI PREKIDAČI . . . . . PRMR

<p>2,5/100A 250V Montaža 20 mm - print ITT / PREH</p>  <p><b>19</b> 9,00</p>	<p>2,5/100A 250V Montaža 20 mmØ2,4 mm GRUNDIG</p>  <p><b>20</b> 6,00</p>	<p>2,5/100A 250V Specijalna montaža TELEFUNKEN</p>  <p><b>21</b> 6,00</p>
---	---	--

<p>2,5/100A 250V Specijalna montaža TELEFUNKEN / PREH</p>  <p><b>22</b> 11,00</p>	<p>2,5/100A 250V Montaža 36 mmØ3,2 mm GRUNDIG</p>  <p><b>23</b> 6,00</p>	<p>4/100A 250V Montaža 23 mmØ3,2 mm GRUNDIG</p>  <p><b>24</b> 6,00</p>
--	---	---



<p>4/100A 250V Montaža 20 mmØ3,2 mm GRUNDIG</p>  <p><b>25</b> 8,00</p>	<p>4/100A 250V Montaža 26 mmØ3,2 mm SONY</p>  <p><b>26</b> 6,00</p>	<p>4/100A 250V Montaža 20 mmØ3,2 mm SIEMENS</p>  <p><b>27</b> 6,00</p>
---	--	---









# PREKIDAČI

PR

## MREZNI PREKIDAČI . . . . . PRMR

<p>4/80A 250V Montaža 25 mmØ3,1 mm ITT</p>  <p><b>28</b> 24,00</p>	<p>4/64A 250V Montaža 25 mmØ3,6 mm NORDMENDE</p>  <p><b>29</b> 24,00</p>	<p>4/80A 250V Montaža 23 mmØ3,2 mm PHILIPS</p>  <p><b>30</b> 11,00</p>
---	---	---

<p>4/80A 250V Montaža 18 mmØ2,5 mm SABA</p>  <p><b>31</b> 12,00</p>	<p>4/64A 250V Montaža 18 mmØ2,5 mm NORDMENDE</p>  <p><b>32</b> 14,00</p>	<p>5/100A 250V Specijalna montaža PREH</p>  <p><b>33</b> 20,00</p>
--	---	---



<p>4/64A 250V Specijalna montaža ITT / LUXOR</p>  <p><b>34</b> 16,00</p>	<p>5/80A 250V Montaža 26,5 mmØ3,5 mm SONY</p>  <p><b>35</b> 16,00</p>	<p>2,5/80A 250V Specijalna montaža FERGUSON</p>  <p><b>36</b> 11,00</p>
---	--	--









# PREKIDAČI

PR

## MREZNI PREKIDAČI . . . . . PRMR

<p>2,5/80A 250V Specijalna montaža FERGUSON</p>  <p><b>37</b> 12,00</p>	<p>5/100A 250V Montaža 18 mmØ3,2 mm FERGUSON</p>  <p><b>38</b> 12,00</p>	<p>5/100A 250V Montaža 20 mmØ3,2 mm FERGUSON</p>  <p><b>39</b> 12,00</p>
--	---	---

<p>5/100A 250V Specijalna montaža FERGUSON</p>  <p><b>40</b> 12,00</p>	<p>2,5/80A 250V Montaža 24 mmØ2,5 mm FRONTECH</p>  <p><b>41</b> 16,00</p>	<p>2,5/100A 250V Montaža 18 mmØ2,5 mm FRONTECH</p>  <p><b>42</b> 12,00</p>
---	--	---

<p>PHILIPS ANUBIS-A+CP90NCR+G90E+GR1-AX</p>  <p><b>43</b> 24,00</p>	<p>PHILIPS FL1.x + FL2.x</p>  <p><b>44</b> 24,00</p>	<p>PHILIPS MD1.2E</p>  <p><b>45</b> 24,00</p>
--	---	--