

SYSTEM Q

PROGRAMMABLE LOGIC CONTROLLERS

**One platform.
Many solutions.**



**PLC Control /// Motion /// PC /// Process /// Multi CPU solutions ///
Redundancy /// IEC 1131.3 /// Networking /// Scalable ///
Machine control /// Plant management ///**

Global Standards



Through Mitsubishi Electric's vision, "Changes for the better" are possible for a brighter future



Mitsubishi Electric Corporation Nagoya Works is a factor certified for ISO14001 (standards for environmental management systems) and ISO9001(standards for quality assurance management systems)



Flexible automation

System Q provides total global solutions for a vast range of applications. Pioneered by Mitsubishi, System Q is a single automation platform that brings together modular control features from a variety of different engineering disciplines, including traditional and advanced programmable logic controllers (PLCs), information technology, motion and process-based control philosophies. Because the focus is on boosting productivity, the System Q automation platform helps users reduce the total cost of ownership while increasing their return on investment

Manufactured to the highest standards

Mitsubishi automation products enjoy a global reputation for outstanding quality and reliability. The process starts at the design stage, where quality is designed into even the smallest components. Our systematic pursuit of "best practice" means that Mitsubishi products readily comply with shipping approvals, product directives and standards.

The world's Number One maker of PLCs

The 2004 Worldwide PLC Survey conducted by the respected American automation research company ARC confirmed that Mitsubishi Electric is the world's largest volume producer of PLCs.

Contents

Range overview	4	
PLC control	6	
Motion control	8	
Process control	10	
PC control	12	
AnS platform	14	
Programming	15	
Plant solutions	16	
Machine solutions	17	
Applications	18	
Section 2: Technical Informations		

What makes a world beating



Global use

A wide range power supply means your Modular System Q will work all over the world and with the huge range of shipping approvals, CE compliance, as well as manufacturing to Automotive industry quality levels, System Q is a product to trust.



Totally scalable

System Q is designed to grow with your application, from the Q00J standalone solution to the networked and redundant process CPU Q25PRH. System Q's platform concept allows you to add and customize the special functions you need.



Multi CPU

The System Q Automation Platform allows you to use multiple CPU's on a single backplane. You can combine up to four CPU types, such as PLC, Motion, PC, Q-C and Process CPU's, as a single seamless solution.

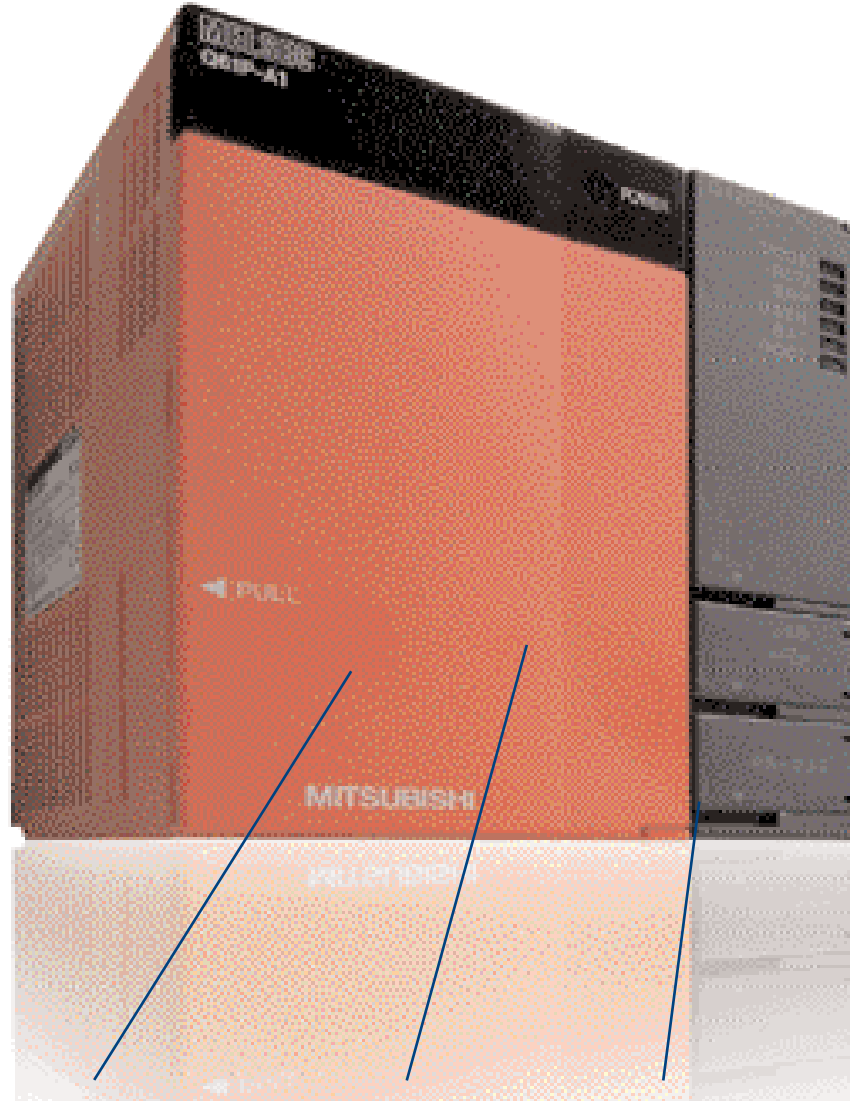

Single or redundant power supplies (AC and DC)

Programming via USB, Serial, Network (Ethernet, Melsecnet)

Task sharing with multiple CPU's, (up to four different CPU's in a single system)

Modular Controller?



Easy maintenance with bright LEDs indicating the operational status

All CPU's support the same range of I/O and special function modules

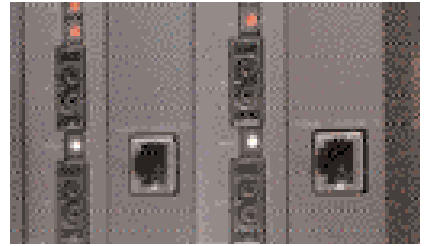

Multi network connectivity

From basic AS-Interface to Ethernet based networks, System Q can communicate easily with Mitsubishi or third party products. To increase the productivity in your plant, System Q can also provide a direct connection to any database based on SQL via an Ethernet connection.



Flexibility

The wide range of power supplies, CPU's, I/O Modules, Special Modules and Communication Modules makes System Q one of the most flexible modular automation systems in the world.



Dual redundancy

The redundant Process CPUs Q12/25PRH can, with standard PLC technology, provide a hot standby system with the automatic synchronization of data. The modular concept also allows different degrees of redundancy from power supply and control systems to redundant network modules.

Sophisticated yet simple

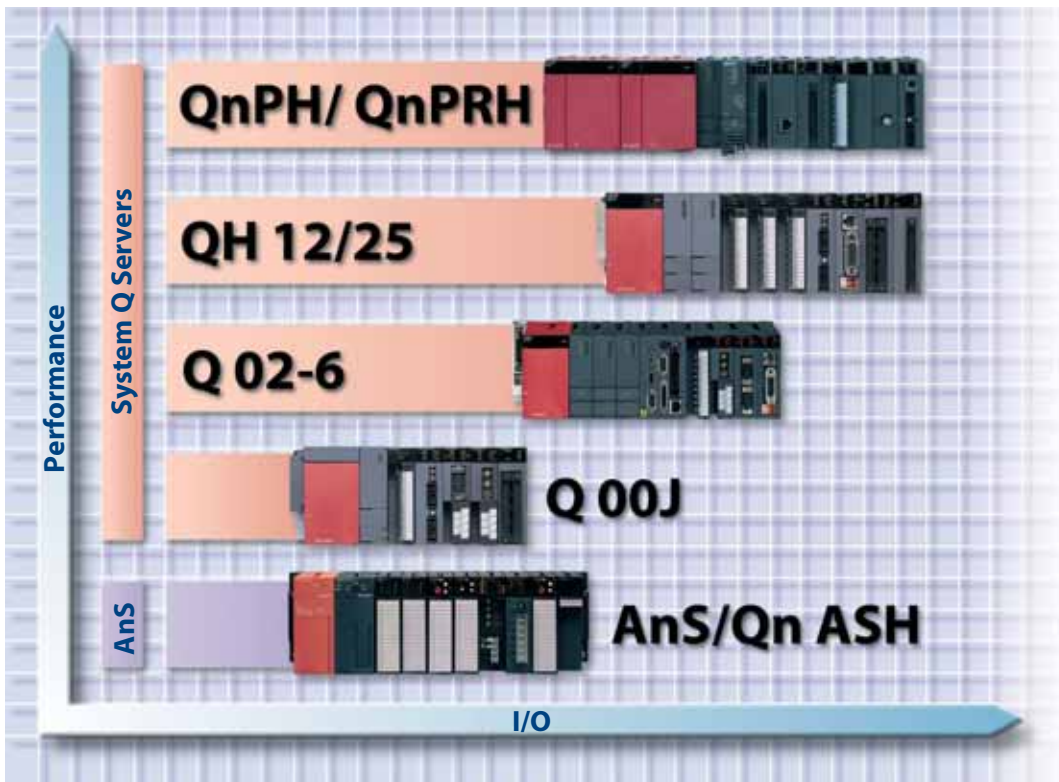

Mitsubishi Electric's modular control solutions span a wide range of capabilities.

The modular concept

Building on its predecessor, the AnSH, System Q is a control concept that allows users to mix and select the best combination of CPUs, communication devices, specialist control modules and discreet I/O on a back-plane. This allows users to configure systems into what they need, when they need it, where they need it.

Multiple capabilities

Basic and advanced PLC CPUs, specialist motion and process controllers and even PCs can be combined into a single SystemQ solution with up to four different CPUs. This gives users a choice of control philosophies, programming concepts and programming languages – all from a single platform.

An automation platform for the future

Flexibility and scalability are key design features that enable System Q to truly be a single Automation Platform. Users can apply simple control to an individual machine or integrated plant wide management all from the same hardware base.

Supporting the System Q platform is a suite of software tools enabling easy and comprehensive integration through EZSocket, Mitsubishi's own middleware. In addition, Mitsubishi also offer software tools that comply with international standards such as IEC1131.3, OPC and Active X. This tremendous flexibility permits users to reduce development time, simplify commissioning, and provide ongoing system maintenance.

Modular control



Reliable control when you need it most.

Basic PLCs

Not every control application requires the full power of System Q. For example, many machine builders embed control technology into their machines and require small compact designs featuring flexible high-speed operation. System Q's Basic PLC CPUs offer just this kind of solution, balancing power and performance against cost. A good example of this is the Q00J CPU.

This all-in-one unit provides power supply, CPU and backplane as a single, ready-to-use unit ideal for small systems that still require powerful performance. Other Basic PLC CPU options include the classic modular designs Q00 and Q01, the first steps on the path to the full System Q automation platform.

PLC CPU Overview		
CPU Type	Basic PLC	Advanced PLC
Model range	Q00J – Q01	Q02 – Q25H
Total Inputs/Outputs	256 – 1024 / 2048	4096/8192
Memory Capacity	58 – 94 kB	32 MB
Program memory	8 k steps – 14 k steps	28 k steps – 252 k steps
Program cycle period per logical instruction	0.20 – 0.1 μ s	79 – 34 ns
Multi CPU capability (Max. 4 CPUs)	Yes on Q00CPU and Q01CPU	Yes – up to 4 per system

Advanced PLCs

For advanced machine designs and controlling manufacturing cells, including infrastructure and site-wide management, System Q's advanced PLC CPUs offer incredible performance and versatility.

Processors are available with a wide range of memory capacities, all of which can be expanded as required. This means that System Q PLCs can support complex programs as well as store large volumes of operation data.

Scalable

With the exception of the embedded Q00J CPU, all System Q PLC processors are interchangeable, which means processing power can be increased as applications grow, protecting your investment in infrastructure and hardware.



Multi CPUs can make light work of complex tasks

Multi Processor support

Up to four separate System Q PLC CPUs can be placed in a single system. These can be used to control their own set of dedicated tasks or for sharing the processing and control load, making the total system highly responsive. This provides users with faster, more dynamic control, leading to better production quality and improved production rates.

Power in motion



High speed and high levels of control and reliability. System Q's automation platform can deliver even in the most demanding applications.

To control these servo systems as well as those made by other manufacturers, System Q offers solutions ranging from individual motion/positioning cards to advanced motion CPUs capable of synchronised operation across many axes.

In control

System Q's unique design allows users to select and use different combinations of CPUs from the same platform. For example, motion CPUs can be employed independently or in tandem with PLC, PC or process CPUs.

Thanks to the dedicated motion control network SSCNETIII, each motion CPU can connect up to 32 servo axes. In addition, three motion CPUs can be used in a single System Q solution to bring advanced motion control to 96 axes.

In control

Modern manufacturers insist on fast, reliable production. This means that machine builders have to find ever-more creative ways of increasing machine performance, reducing commissioning times, and minimizing maintenance. Not an easy task.

One way of achieving these goals is the increased use of servo and motion technology. Mitsubishi Electric leads the way here with innovative servo drives featuring advanced auto tuning, meaning that they practically configure themselves.



System Q brings machine control and motion into harmony.

Motion CPU overview	
CPU Type	Motion Controller
Model	Q172HCPU Q173HCPU
Control axes options	8 32 (up to 96 axes when 3 CPUs are used in one system)
Total Inputs/Outputs	4096/8192
Number of positioning data items	3200 positioning points
Program memory	14 kB PLC program, 543 kB total servo positioning program
Processor speed /cycle time	0.4 ms cycle time (SV13)
Multi CPU capability	Yes – up to 3 Motion CPUs per 4 CPU system

For users who do not need a full motion controller, System Q offers over 12 individual control cards. Each type of special function card is available in a range of 1, 2, 4 or 8 control axes; control methods include open collector and differential output, as well, of course, as the SSCNetIII. Also available are standard, general purpose, pulse train output cards, and high-speed counter cards.



Flexible control options from a single platform.

Given this wide range of motion CPUs and dedicated control cards, it is easy to see how System Q can be customized to work with almost any servo manufacturer's products, as well as being totally optimized for use with Mitsubishi Electric's own advanced servo solutions.

Networking: speed and reliability

SSCNet is a dedicated motion controller network developed by Mitsubishi Electric. It offers many advantages for fast, secure communications between up to 96 servo systems and their host controller.

The latest version is SSCNETIII, a powerful third-generation product. It enables high-speed, full duplex, transfer rates of up to 50MB/s as well as guaranteed network system cycle times of 0.44ms. This extends to all 96 axes, making sure that user applications are really synchronised over all active servo drives.

SSCNET

SERVO SYSTEM CONTROLLER NETWORK

The use of fibre-optic cabling is a great benefit to all users as it eliminates any concerns about stray electrical noise corrupting the high-speed communication process. This means SSCNETIII users enjoy greater reliability and flexibility since the fibre-optic cables can be placed wherever they're needed – even alongside large electrical motors.



Servo and motion solutions are increasingly being used across many applications.

Positioning card overview						
Control method	Open collector		Differential output		Network	
					SSCNET III	SSCNET
Model (* Is the number of axes)	QD75P*	QD70P*	QD75D*	QD70D*	QD75M*	QD75MH*
Control axes options	1, 2, and 4	4 and 8	1, 2, and 4	4 and 8	1, 2, and 4	
Control units	mm, inch, pulse and degree	pulse	mm, inch, pulse and degree	pulse	mm, inch, pulse and degree	
Number of positioning data items	600 data items/axes	10 data items/axes	600 data items/axes	10 data items/axes	600 data items/axes	

Process control you can count on



Reliable system operation is essential in the process industry.

A platform to build on

The strength of System Q's automation platform really comes into its own in traditional specialist industries. The unique flexibility of proven off-the-shelf control components such as I/O and communication devices, teamed with dedicated special devices like process CPUs, assures high functionality, ease of use and targeted control – all within budget.

Two worlds meet

Our dedicated System Q process CPUs build on the already high functionality of Mitsubishi's advanced PLC CPUs. This powerful combination of sequential control overlaid with dedicated process instructions gives users a hybrid control solution with the best of both worlds.

This is complemented in turn by a range of dedicated channel-isolated and high-resolution analogue modules. Here, too, a combination of specialist and standard modules provides the basis for practical and flexible solutions.

High system availability can be maintained through various means, including redundant process CPUs, stand-by network masters, and redundant network configurations, as well as by wire-break detection and a "hot-swap" capability that allows modules to be replaced during live operation.

Programming can be implemented using a wide range of tools such as IEC1131.3 compliant software and the process-dedicated PX Developer.

Process CPUs

System Q's Process CPUs bring the benefits of standard System Q technology into the process environment, reducing both implementation and long-term running costs. These powerful processors combine standard PLC control with 52 dedicated process control functions, including loop controls with two degrees of freedom (DOF) and high-speed PID control.



The high availability of the dual redundant System Q can be applied to a wide range of industries from Food and Utilities to Process, and Chemical.



Complex processes involving liquids, pressures, temperatures can often need fast PID control algorithms.

High reliability systems

The System Q automation platform can also be applied to other areas requiring high reliability, e.g. standby network masters, redundant fieldbus (CC-Link) and redundant power supplies for remote I/O stations.

Redundant CPUs

Mitsubishi Electric's dual-redundant CPUs bring an additional layer of fault tolerance to the control of a whole system. This results in high reliability: if the main CPU, power supply or base unit fails, a secondary system starts immediately (within 21ms) from the same control point.

In addition, selected analogue and temperature control units have a wire-break detection feature enabling them to determine the difference between an actual signal and one that has been lost due to external system damage.

For users this has two major benefits: no operational damage due to a single system failure, and production that continues seamlessly.

Overview of Process CPUs				
CPU Type	Process CPU		Redundant CPU	
Model	Q12PHCPU	Q25PHCPU	Q12PRHCPU	Q25PRHCPU
Total Inputs/Outputs	4096/8192			
Memory Capacity	32 MB			
Program memory	124 k steps	252 k steps	124 k steps	252 k steps
Program cycle period per logical instruction	34 ns			
Multi CPU capability (Max. 4 CPUs)	Yes - up to 4 per system		No	

IT for support, monitoring and control



Integrated, embedded or networked – IT is the link from the operational environment to the management function.

Information technology has emerged as the prime conduit linking the operational site to the management function. Not only can production data, schedules and quality information be shared; maintenance and operations can be activated over the same structures.

Industrial strength IT

System Q is unique in being able to embed a fully equipped Windows™ PC into a robust industrial design directly at the heart of the control system. The potential uses and benefits are enormous: users are completely free to write their own control and directly actuate I/O control.

Alternatively, it can be used as an embedded monitoring point, running a SCADA installation or user-created VB applications.

With a fanless design concept, the unit is designed to have as few moving parts as possible, as these are often the points of operational failure. In fact, this principle extends to the optional silicon hard drive, which has no moving parts at all, making Mitsubishi Electric's System Q PC ideal for an industrial environment.



Flexible and secure PC technology can even be placed within an application.

This rack-based PC solution can be used as a stand-alone controller or in conjunction with any other System Q CPU to create a multidisciplinary automation platform.

As easy as A, B, C

If System Q's automation platform is divided into A for PLC CPUs, and B for process CPUs, then C must surely stand for the industrial "C" controller. This advanced controller can be programmed in standard C or C++, opening up the world of automation and control directly to non-PLC based engineers. Furthermore, "C" programming is an ideal language for many process or complex math-based applications since it has a well-defined structured programming concept and flexible syntax.



System Q's C controller adds a whole new dimension to flexible control

The Q06CCPU module has been meticulously designed to eliminate as many failure-prone elements as possible, including fans and hard drives. Combined with the widely used VX-Works operating system from Wind River, this makes Mitsubishi's C Controller a powerful CPU fit for industrial environments. In addition, programming support for the CoDeSys controller development system is available from 3S-Smart Software Solutions, which provides users with convenient object-oriented environments.

Remote management

System Q offers various solutions to the problem of remote management. These can be used independently or combined into multifunction systems.

■ Networking

System Q supports over 50 different types of networking and communications modules, including Ethernet, MELSECNET/H, FL-NET, Profibus/DP, CC-Link, CANopen, DeviceNET, AS-interface, Modbus TCP, Modbus RTU and GP-IB. Thanks to System Q's single automation platform, communication is as easy as selecting the module you need.

From System Q's single automation platform communication can be as easy as selecting the module you need.



Flexible and reliable communication is a key issue in many application regardless of scale and size.

■ Webservice

The QJ71WS96 is a dedicated webservice module that fits directly onto the System Q backplane. It offers on-board webpages as well as Java scripting and 100MB Ethernet that make it easier than ever to share information.



Web server technology brings intuitive access directly to the heart of the control solution.

■ Telemetry

Mitsubishi Electric offers two different modem solutions: basic and intelligent. Both types are available in triband GSM or PSTN formats and feature completely intuitive set-up software. This makes programming with Haynes control codes a thing of the past.

MES Interface

With the QJ71MES96 module System Q users now have the possibility to connect directly with commercial database applications like Oracle, MS SQL Server and MS Access. The MES module supports bi-directional data transfer with several databases and the event-driven communications reduce the network load. The use of the MES module reduces system complexity and cost, making gateways a thing of the past.

IPC panels

Information technology also comes to the System Q automation platform in the form of industrial personal computers (IPCs). These units provide an ideal solution for placing a PC access point directly in the production environment. Models can be connected directly to System Q or via a network, ensuring that all areas of the operation are kept supplied with up-to-date information directly from System Q.

Overview of System Q PC and C Controller CPUs		
CPU Type	PC	C Controller
Model	PPC-CPU852(MS)-512	Q06CCPU
Total Inputs/Outputs	4096/8192	4096/8192
Memory Capacity	Use of storage cards means data and programs can be stored for later retrieval	Use of storage cards means data and programs can be stored for later retrieval
Program memory	512 MB (main) / 2 MB (cache)	32 MB (main) / 128 kB battery backed
Processor speed/cycle time	Intel Celeron M 600 MHz	RISC processor is 236 MHz
Multi CPU capability (Max. 4 CPUs)	Yes - one per system	Yes

Proven technology

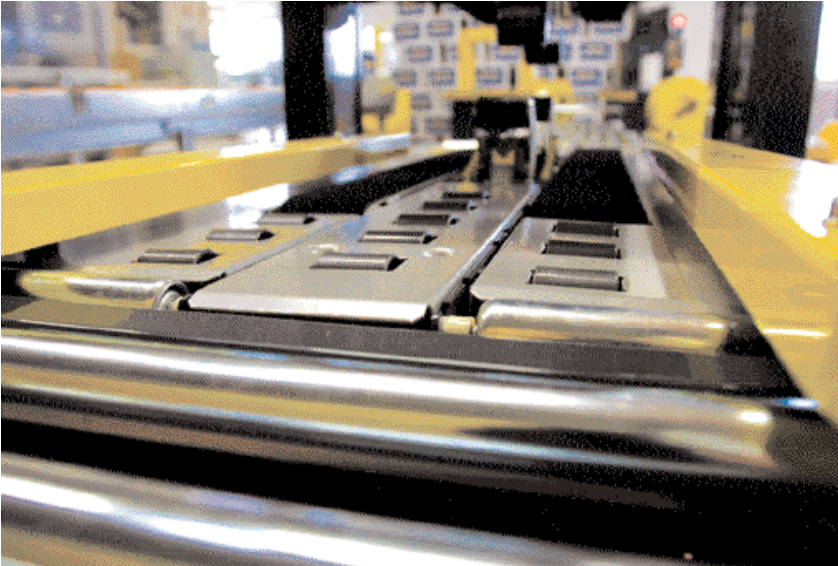

FX1S has been used in a wide range of embedded control applications.

All round control

Working tirelessly and reliably, existing CPUs from Mitsubishi such as the AnS, AnSH, QnAS and QnASH have brought innovation and ease of use to many shop floor applications – qualities shared by the latest generation of control technology: System Q.

Compatibility

For customers who are considering changing to System Q there are many benefits: increased processing speed, multi CPU capabilities, and wider ranges of modules all designed to make the system engineer's life just that little bit easier.

Things to remember

When upgrading from AnS or QnS systems to System Q, the part numbering is simple and familiar – Q replaces A1S, for example; A1SX80 becomes QX80. Programs can be transferred from an existing installation using Mitsubishi's GX and GX IEC



Mitsubishi modular PLC solutions have a reputation for reliability and quality.

Widely used

Users from many different industries have long placed their trust in Mitsubishi modular PLCs to control their processes or machines. In fact, ARC's 2004 Worldwide PLC Survey ranks Mitsubishi as the world's largest volume producer of PLC products.

ARC is protected by ARC Advisory Group copyright 2004.

Overview of modular PLC CPU's							
CPU Type	AnSH			QnAS		QnASH	
Model	A1SHCPU	A2SHCPU	A2SHCPU-S1	Q2ASCPU	Q2ASCPU-S1	Q2ASHCPU	Q2ASHCPU-S1
Total Inputs/Outputs	256	512	1024	512	1024	512	1024
Program memory	8 k steps	14 k steps	30 k steps	28 k steps	60 k steps	28 k steps	60 k steps
Processor speed / logical LD instruction	0.33 μ s	0.25 μ s		0.2 μ s		0.075 μ s	
Suggested System Q alternative	Q00	Q01	Q02	Q02	Q06H	Q02	Q06H

Programming and visualisation

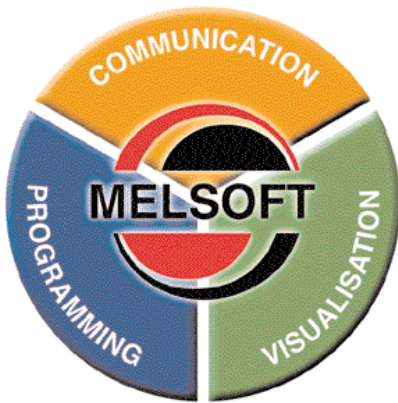

Mitsubishi's MELSOFT suit of software tools brings productivity and ease of use.

One of the largest cost components of any project is not the control hardware but the time required to create and write the application. Mitsubishi's MELSOFT software solutions help you save time by making it easier to reuse existing work, as well as making interfaces simpler and more intuitive. In addition, MELSOFT provides innovative tools to help users increase their productivity in planning, implementation, service and support.

■ Programming

Three software packages are available: one in standard Mitsubishi format, another in compliance with IEC1131.3, and a dedicated process control solution. This enables customers to choose the best solution for their needs. Mitsubishi's programming solutions help you save time by making it easier to reuse existing programming code; they also have simple, intuitive interfaces.



Advanced software packed in an easy to use interface.

■ Communication

MELSOFT communication packages are designed to integrate Mitsubishi products with other software packages by using plug-ins or drivers. The user benefits from the reliability and quality of Mitsubishi hardware combined with the familiarity of software tools such as Microsoft Excel, Active X and OPC.

■ Visualization

Mitsubishi supplies both SCADA- and PC-based HMI solutions for data analysis, maintenance and linking into other high-end business operations packages.

Human Machine Interfaces

In addition to software visualization solutions, Mitsubishi Electric offers one of the world's widest ranges of HMI, GOT and IPC technologies. Solutions range from simple small text screens all the way through to high- resolution touch screens and full-fledged industrial PCs, complementing the range and power of System Q.

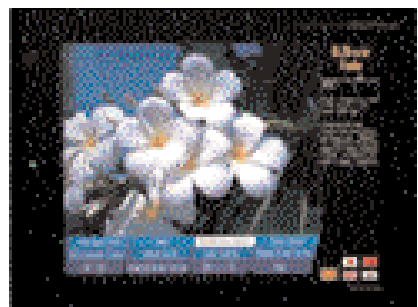

GOT1000 displays offer high resolution and touch screen technology.

Package	GX IEC Developer	GX Developer	PX Developer
IEC1131-3 compliance	Yes	No	No
Languages	LD/IN/FB/ST/SFC	LD/IN/SFC	LD/IN/SFC
Simulator	No	Optional	No
Special function block setup utilities		Yes	Yes

LD = Ladder, IN = Instruction, FB = Function block, ST = Structured Text, SFC = Sequential Function Chart

Plant solutions

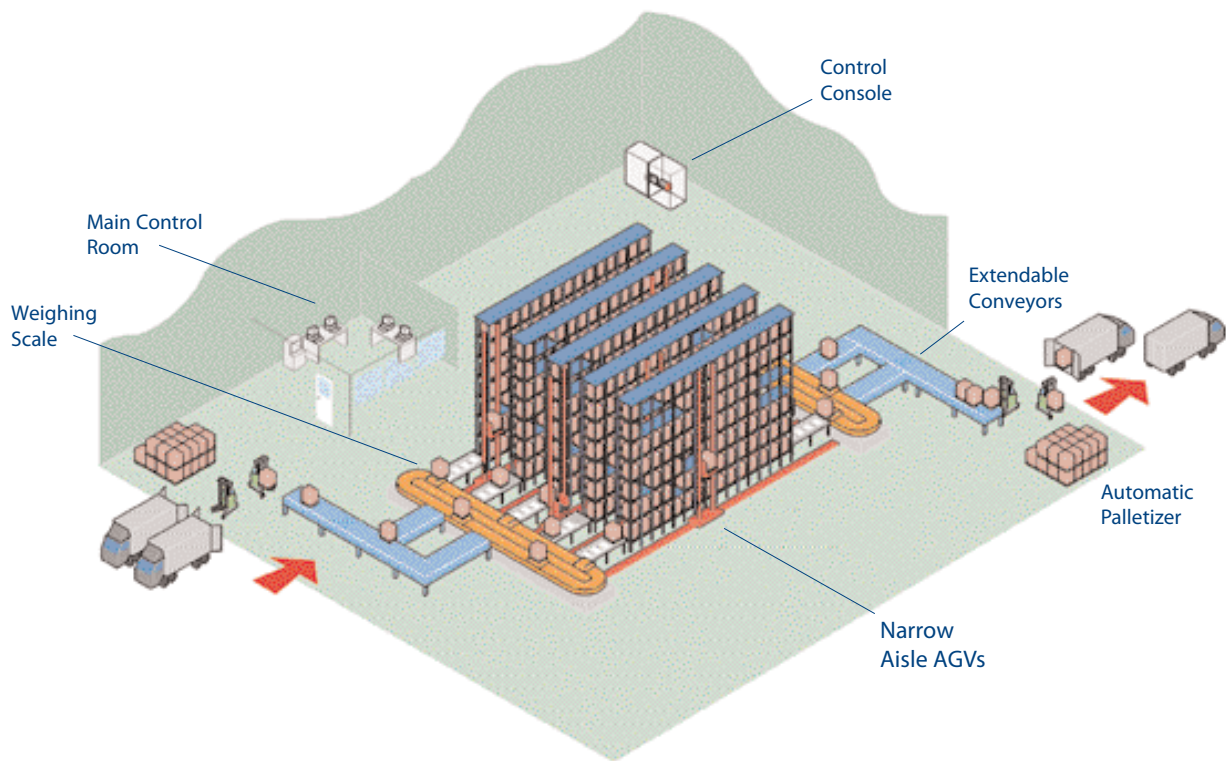

Optimal operation occurs when all elements within a plant are kept constantly running, this can only be achieved with reliable co-ordination and integration.



e-F@ctory turns the idea into a reality.

Companies often mull over and discuss factory or plant-wide management solutions for many years – but without ever actually implanting them. After all, they are understandably reluctant to halt production for an extended period while the new system is being fitted, and find the prospect of organizing and planning the whole activity daunting, especially since they often want to implement a new solution all at once.

Making life easy

Traditionally, the interface between MES and the production environment has been separated by a layer of management PCs and master PLCs used for concentrating data and cell information. With System Q's automation platform, this structure can be simplified by embedding the PC directly on the same backplane. This removes a layer of management structure as well as simplifying implementation.

e-F@ctory

Mitsubishi Electric's e-F@ctory solution answers a lot of these issues. It is based on the System Q automation platform concept. Thanks to System Q's modular design, it is now much easier to implement plant-wide control based on segmented or manufacturing cell solutions.

Each customer's requirements are different and System Q is designed to offer a wide range of solutions that can be easily adapted. For example, System Q enables the use of local embedded webserver technology, meaning that Ethernet and web-based browsing can be used for capturing data. Moreover, a dedicated MES interface allows System Q to "talk" directly to the MES software without any intermediary devices, reducing implementation and on-going maintenance costs.

Communication

Plant-wide operations rely on good communication strategies. System Q's automation platform can support over 50 different forms of communication, including standard RS232, fieldbuses, Ethernet, webservers and redundant networks.

Machine solutions

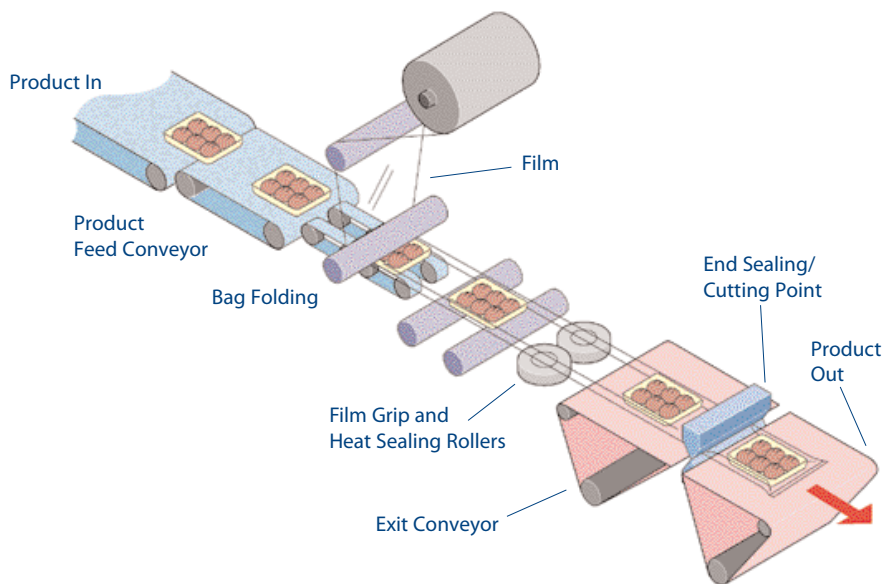

A horizontal packaging machine can present many challenges to the automation engineer.

Each machine presents different challenges to the control system. Sometimes high quantities of I/O are required locally or are networked. Small controller size is often important, while at other times the key factors will be temperature, positioning, or analogue control.

For the machine designer, an ideal solution is to have a standard control philosophy that can be adapted to each machine's individual needs. This is exactly what System Q brings to machine control.

Compact

Due to its modular design, System Q uses less panel space than many other controllers. In addition, Mitsubishi offers a wide range of high-density I/O cards and analogue modules that are ideal for minimizing installation space. For very compact installations, System Q offers an all-in-one solution comprising a backplane, CPU and power supply which is supported by an extensive range of network options for I/O and devices.

Flexible

When designing a control system for a given machine, flexibility is often a key requirement. Many machine manufacturers develop ranges of products which require a basic control concept to which additional features can be added as machine performance increases. The System Q automation platform is ideally suited to this.

System Q encompasses a wide range of modules, including more than 22 different types of temperature and analogue modules, 20 different positioning modules, and a wide range of communication devices.



Example of temperature control.

Supporting this are basic and advanced PLC CPUs as well as webservers, PC CPUs, Process CPUs, C Controllers, Motion CPUs and redundant CPUs.

Easy programming

One of the largest costs in any control solution is the programming and engineering time. System Q overcomes this with user-friendly, intuitive programming tools. In addition, we place great emphasis on reusable program code, employing function blocks and a sequential function chart. Embedded set-up tools support this process, making the configuration of special function modules simple, quick, and easy.

A world of applications



Plant control solutions

Mitsubishi products are found in an almost infinite variety of industrial, infrastructure and service sector contexts, ranging from critical applications in the pharmaceuticals industry to state-of-the-art leisure and entertainment facilities. Here are just a few examples of recent applications:

- Agriculture
 - Irrigation systems
 - Plant handling systems
 - Sawmills
- Building management
 - Smoke detection monitoring
 - Ventilation and temperature control
 - Lift (elevator) control
 - Automated revolving doors
 - Telephone management
 - Energy management
 - Swimming pool management
- Construction
 - Steel bridge manufacturing
 - Tunnel boring systems

- Food and drink - Bread manufacture (mixing/baking)
 - Food processing (washing/sorting/slicing/packaging)
- Leisure
 - Multiplex cinema projection
 - Animated mechatronics (museums/theme parks)
- Medical
 - Respiration machine testing
 - Sterilization
- Pharmaceutical/chemical
 - Dosing control
 - Pollution measurement systems
 - Cryogenic freezing
 - Gas chromatography
 - Packaging
- Plastics
 - Plastic welding systems
 - Energy management systems for injection moulding machines
 - Loading/unloading machines
 - Blow moulding test machines
 - Injection moulding machines
- Printing
- Textiles
- Transportation
 - Sanitation on passenger ships
 - Sanitation on rail rolling stock
 - Fire tender, pump management
 - Waste disposal truck management
- Utilities
 - Waste water treatment
 - Fresh water pumping



Remote management solutions including SCADA, networking, Telemetry and Industrial Modems.

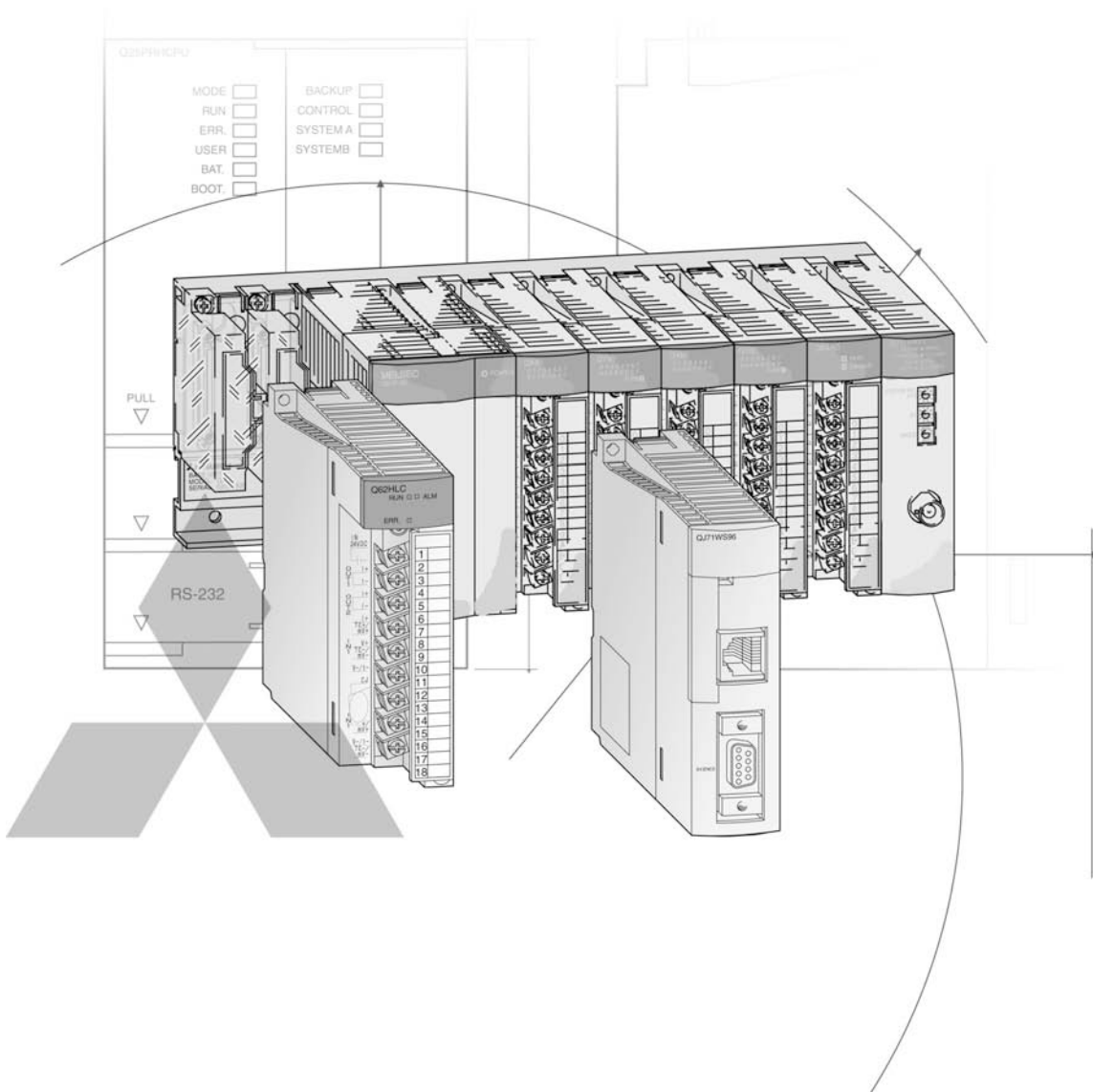

Technical Information Section

Further Publications within the PLC Range

Technical Catalogues

Technical Catalogue Networks

Product catalogue for Master and Slave modules as well as accessories for the use of programmable logic controllers in open and MELSEC networks (art. no. 136730)

Technical Catalogue Alpha, FX1S, FX1N, FX2N, FX3U

Product catalogue for programmable logic controllers and accessories for the MELSEC FX family (art. no. 136744)

Technical Catalogue MMI

Product catalogue for operator terminals, visualisation software and accessories (art. no. 68542)

More information?

This technical catalogue is designed to give an overview of the extensive range of System Q of MELSEC PLCs. If you cannot find the information you require in this catalogue, there are a number of ways you can get further details on configuration and technical issues, pricing and availability.

For technical issues visit the www.mitsubishi-automation.com website.

Our website provides a simple and fast way of accessing further technical data and up to the minute details on our products and services. Manuals and catalogues are available in several different languages and can be downloaded for free.

For technical, configuration, pricing and availability issues contact our distributors and partners.

Mitsubishi partners and distributors are only too happy to help answer your technical questions or help with configuration building. For a list of Mitsubishi partners please see the back of this catalogue or alternatively take a look at the "contact us" section of our website.

About this technical catalogue

This catalogue is a guide to the range of products available. For detailed configuration rules, system building, installation and configuration the associated product manuals must be read. You must satisfy yourself that any system you design with the products in this catalogue is fit for purpose, meets your requires and conforms to the product configuration rules as defined in the product manuals.

Specifications are subject to change without notice. All trademarks acknowledged.

© Mitsubishi Electric Europe B.V., Factory Automation - European Business Group 10/2007

MELSEC System Q

SYSTEM DESCRIPTION

- ◆ Introduction of the Q system 4
- ◆ Configuration and handling..... 10
- ◆ Networks..... 12

BASIC COMPONENTS

- ◆ Base units 14
- ◆ Power supply modules..... 16
- ◆ CPU modules..... 17

DIGITAL MODULES

- ◆ Input modules..... 23
- ◆ Output modules..... 25

SPECIAL FUNCTION MODULES

- ◆ Analog modules..... 27
- ◆ Temperature control modules..... 30
- ◆ Counter modules..... 33
- ◆ Positioning modules..... 34
- ◆ Interface modules..... 37
- ◆ Interrupt modules..... 41

ACCESSORIES

- ◆ Dummy module and System terminals 42
- ◆ Connection cables..... 43
- ◆ Memory cards and connectors 45
- ◆ Adapter and batteries..... 46
- ◆ Accessory for Q PC..... 48

TERMINALS AND DIMENSIONS

- ◆ Terminal assignments..... 50
- ◆ Dimensions 55

PROGRAMMING SYSTEMS

PROGRAMMING

- ◆ MELSOFT software..... 59
- ◆ Visualisation software..... 60
- ◆ Profibus software..... 61

APPENDIX

- ◆ Index..... 63

NETWORK MODULES

- ◆ Please refer to the Networks Technical Catalogue for the MELSEC System Q network modules.

Automation platform MELSEC System Q

Description

With the MELSEC System Q, MITSUBISHI ELECTRIC presents its most powerful and compact modular PLC, with multiprocessor technology for present and future challenges.

The small size, the communications capability and the high-performance multiprocessing are three important characteristics of the MELSEC System Q. Its compactness ensures that it occupies less space in the switchgear cabinet and its diverse communication facilities guarantee flexibility and openness. Depending on the selected CPU type up to 4096 local and up to 8192 remote I/O points can be addressed. This controller is particularly suitable for performing medium- to high-performance automation tasks.

The individual systems can be installed in different MELSEC and open networks (e.g. MELSECNET, CC-Link, Ethernet or Profibus/DP), enabling them to communicate with one another. The number of I/Os can thus be increased several times.

Thanks to the unique combination possibilities of PLC, process, redundancy, PC/C, and motion CPUs a platform is available that meets every automation task.

Special features

- up to 4096 local I/Os
- up to 8192 remote I/Os
- interchangeable intelligence
- multiprocessor technology with 16 different CPU types from 5 families (PLC, process, redundancy, PC and motion)
- wide range of communications facilities
- easy installation
- one system platform for all configurations
- innovative technology for future applications

The MELSEC PLC Family

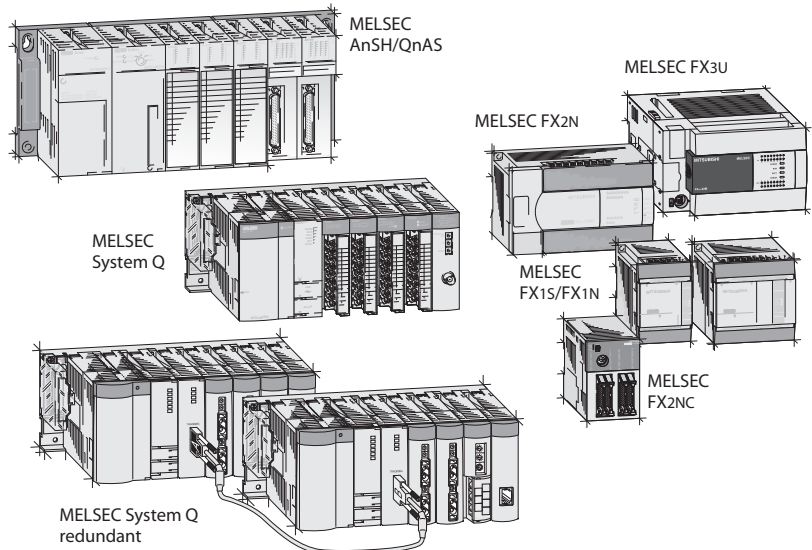

Expandability and performance

As with other Mitsubishi controllers the power of the MELSEC System Q grows with your application – you simply replace or add a CPU. When using the multi processor type CPUs the control and communication tasks are shared by up to four CPUs. Every system can provide a maximum capacity of 4,096 local I/Os or 8,192 remote I/Os.

The integrated memory of up to 252 k program steps (which conforms to 1 MB RAM) can easily be expanded by up to 32 MB memory at any time just by slotting in an extension card (not for Q00(J) and Q01).

Flash ROM cards are also available for permanent storage of your controller programs for the Q02 and H type CPUs. An integrated buffer battery protects the data in the CPU's internal RAM against power failures.

The MELSEC System Q offers state-of-the-art performance by 1 single processor PLC CPUs, 2 process CPUs, 2 redundant PLC process CPUs, 7 multi processor PLC CPUs as well as 2 diverse motion CPUs and 1 PC CPUs.

PLC CPUs (multi processor type)

- **Q00CPU** with 8 k steps program memory and a program cycle period of 0.16 μ s/logical instruction
- **Q01CPU** with 14 k steps program memory and a program cycle period of 0.1 μ s/logical instruction
- **Q02CPU** with 28 k steps program memory and a program cycle period of 0.079 μ s/logical instruction
- **Q02HCPU** with 28 k steps program memory and a program cycle period of 0.034 μ s/logical instruction
- **Q06HCPU** with 60 k steps program memory, program cycle period of 0.034 μ s/logical instruction
- **Q12HCPU** with 124 k steps program memory and a program cycle period of 0.034 μ s/logical instruction
- **Q25HCPU** with 252 k steps program memory and a program cycle period of 0.034 μ s/logical instruction

PLC CPUs (single processor basic type)

- **Q00JCPU** as entry-level model. Here the CPU (8 k/0.2 μ s), base unit and mains adaptor form a compact unit.

Redundant Process CPUs

- **Q12PRHCPU** with 124 k steps program memory and integrated process and redundancy functionality
- **Q25PRHCPU** with 252 k steps program memory and integrated process and redundancy functionality

Process CPUs (multi processor type)

- **Q12PHCPU** with 124 k steps program memory and integrated process function
- **Q25PHCPU** with 252 k steps program memory and integrated process function

Motion CPUs (multi processor type)

- **Q172CPUN** for positioning applications with up to 8 axis (per CPU)
- **Q173CPUN** for positioning applications with up to 32 axis (per CPU)

PC-CPUs (multi processor type)

- **PPC-CPU852(MS)-512** personal computer with Celereon processor, 512 MB RAM and graphics adapter
- **Q06CCPU** C-Controller CPU, real-time operating system, programmable in C++

Selection Criteria

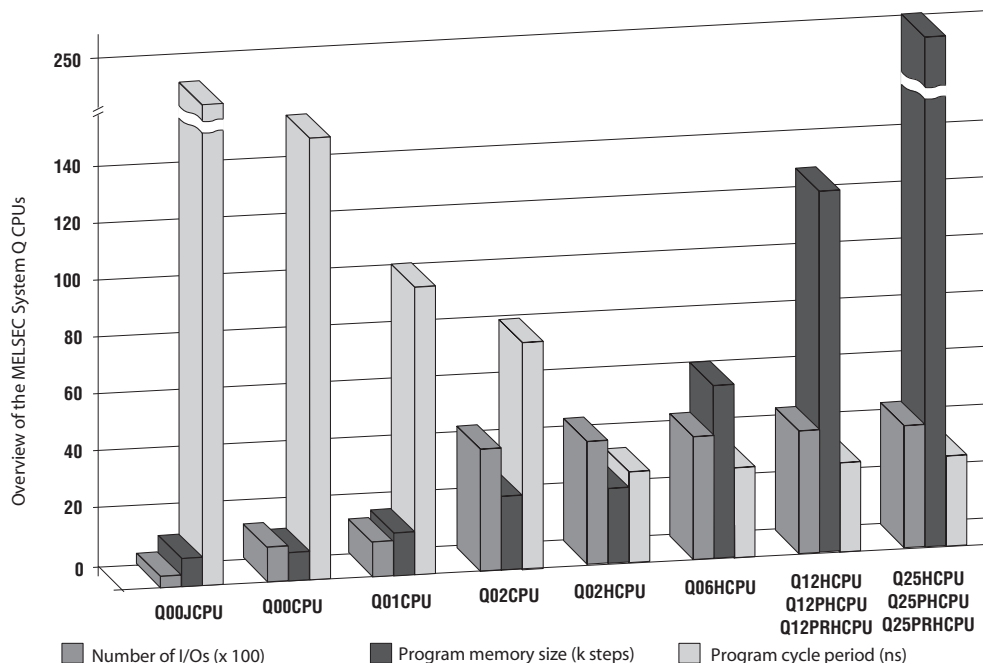

The performance spectrum of the 12 different PLC CPUs offers the right solution for all applications. Combined with the 4 other CPUs possible applications result for high complex processes as well (see also the following page).

Combinations possibilities

Certain combinations are possible for the selection and use of the CPUs. The combination possibilities can be found in the opposite table and in the graphic at the bottom.

Some of the CPUs can be used as a master or as a slave CPU, however the master CPU must always be plugged as the first CPU next to the mains adaptor to the far left.

Combined with other CPUs the PC CPU must be positioned to the far right slot.

Depending on the CPUs used the power supply capacity must be accounted for accordingly (see also page 16).

	Single PLC CPUs	Multi processor PLC CPUs	Motion CPUs	PC-CPUs	C-CPU
CPU types	Q00JCPU, Q12PRHCPU ^② , Q25PRHCPU ^②	Q00CPU, Q01CPU, Q02CPU, Q02HCPU, Q06HCPU, Q12HCPU, Q25HCPU, Q12PHCPU, Q25PHCPU	Q172CPU, Q173CPU	PPC-CPU852(MS)-512	Q06CCPU
Combinations possibilities	Stand-alone	Up to 4 CPUs ^① in combination	In combination with a PLC master CPU	Stand-alone as master. In combination with a PLC Master CPU as slave	Up to 4 CPUs in combination, also with Motion and PLC CPU
Max. number of usable CPUs per system	1 only	Max. 4	Max. 3	Max. 1	Max. 4
Application (hierarchy)	—	Master/slave	Slave	Master/Slave	Master/slave

^① Q00 and Q01CPU in combination with Motion CPU and PC CPU only!
^② Redundant configurations require two systems

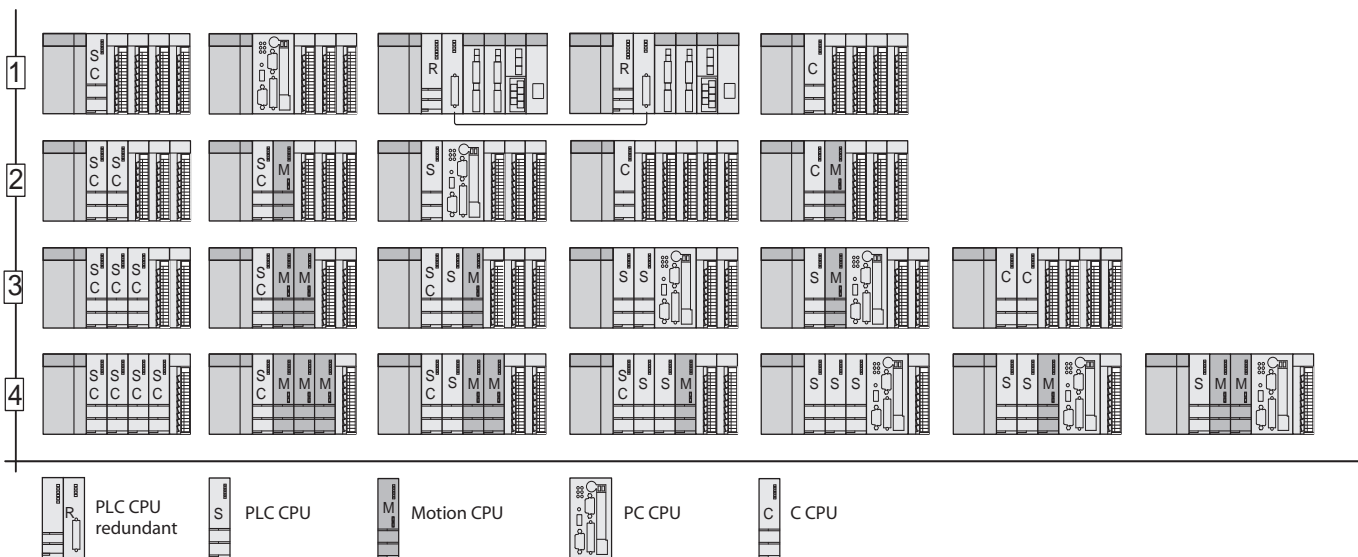

Task Management with Multiple PLC CPUs

Multiple MELSEC System Q series PLC CPUs can be used together to allow a single system to execute controls that are different in tact time, e.g. sequence control and data processing.

Thus sequence control and data processing can be distributed to different CPUs.

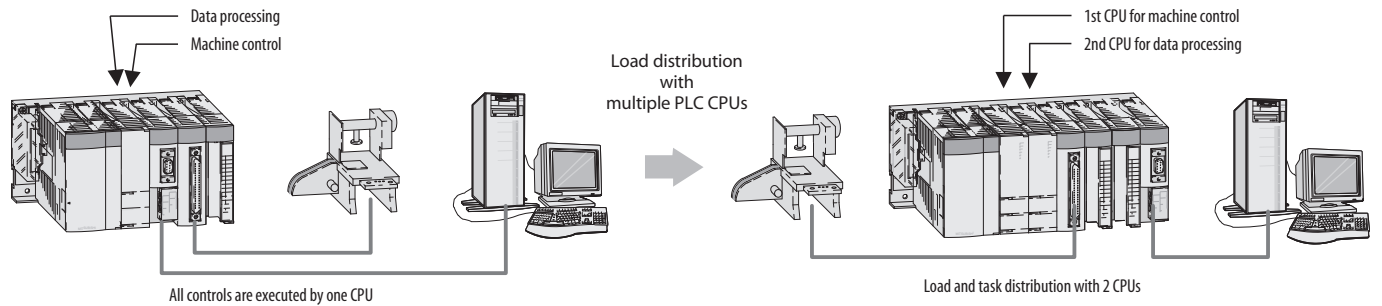

If load in excess of a CPU's processing capability is applied to a large scale system due to a large program size, using multiple CPUs to distribute the load improves the overall performance of the system.

When one process requires fast processing and the other does not, they can be handled respectively by two CPUs, providing

stable and rapid control which is unaffected by the other process.

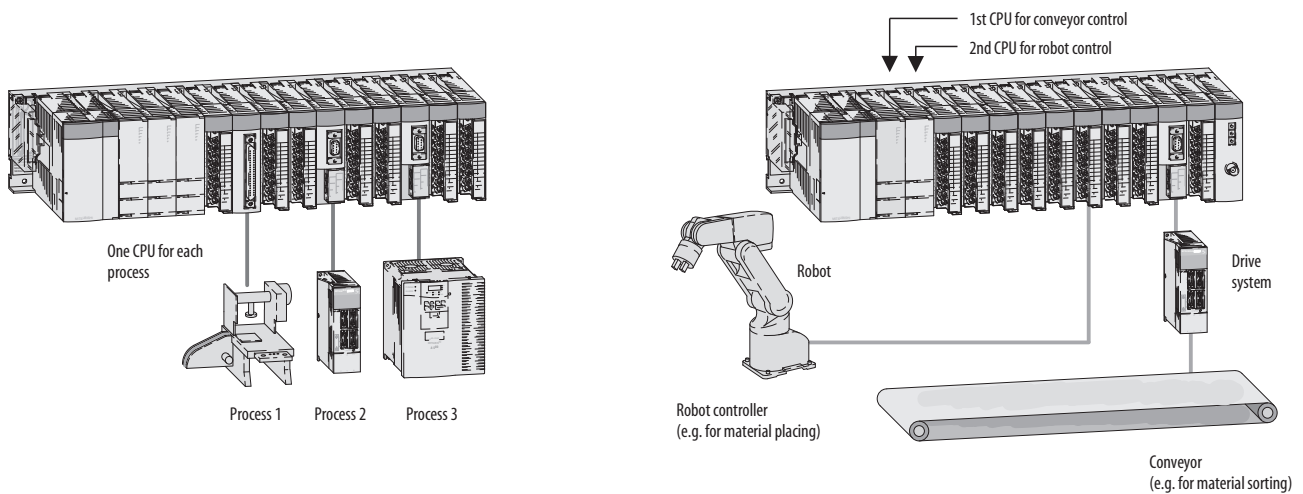

Integration of Motion CPU and Personal Computer CPU

The System Q has the multiple CPU system function which also permits PLC CPUs and Motion CPUs to be loaded together on one base unit. While data exchange is optimized via the back bus of the base unit, space requirements and system costs are significantly reduced at the same time.

A Motion CPU can use the SSCNET that rapidly controls up to 96 axes in a single system and saves wiring. The personal computer CPU (Q-PC) enables the access to I/O modules and intelligent function modules and the communication of all CPUs with each other. When a PC/C-CPU is used the system can also be controlled with a high-level language like C++ or VB

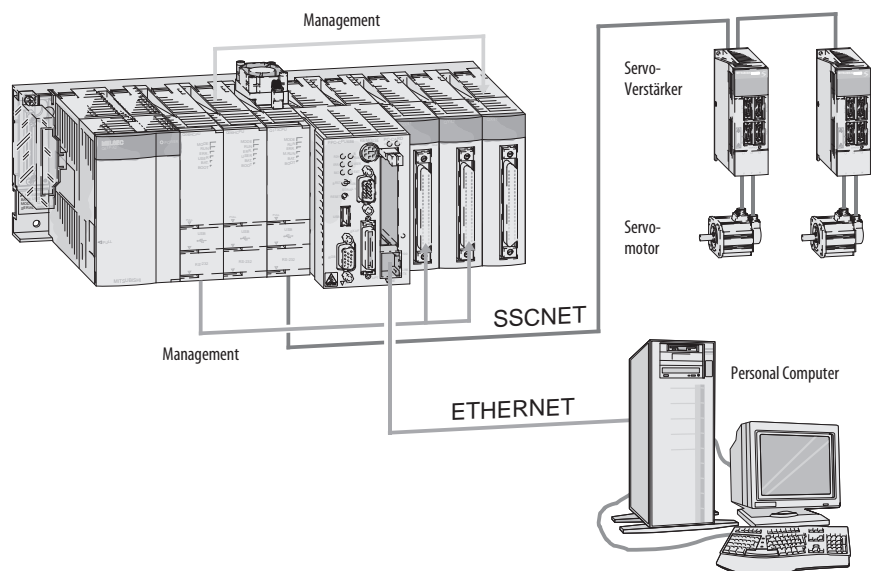

Increasing the Availability of System Q

Redundant System Q

The Q12/25PRHCPU and the QC10/30TR tracking cable can be used to set up a redundant configuration with two identical systems using only standard components. With "hot standby" capabilities redundant setups like this ensure maximum system availability for critical process and manufacturing automation tasks.

Redundant Power Supplies

In combination with the Q38RB base unit and a CPU (except Q00JCPU) the Q64RP and Q63RP redundant power supply units increase operational availability.

Process Capabilities

All redundant power supplies are "hot swappable", i.e. can be replaced while the system is in operation (replace in RUN mode)

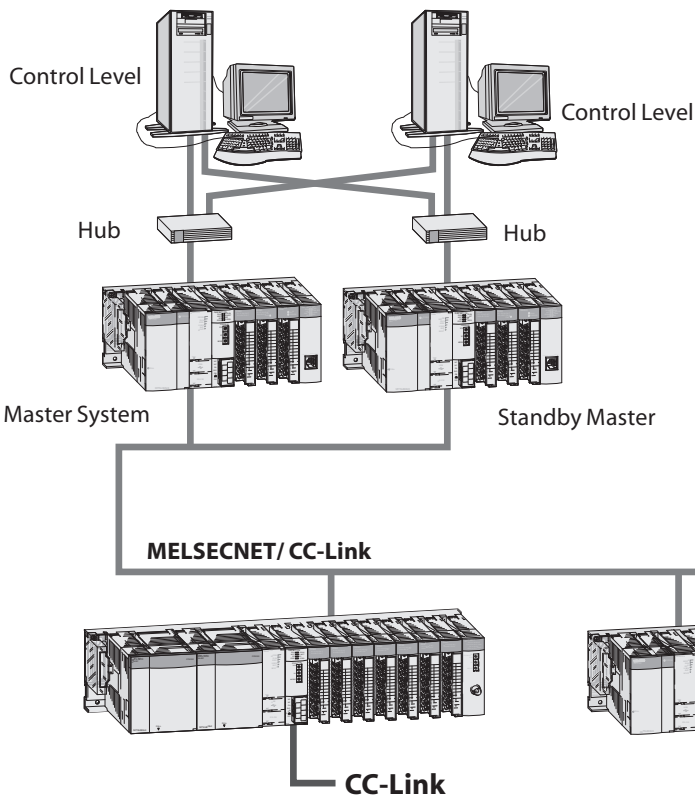
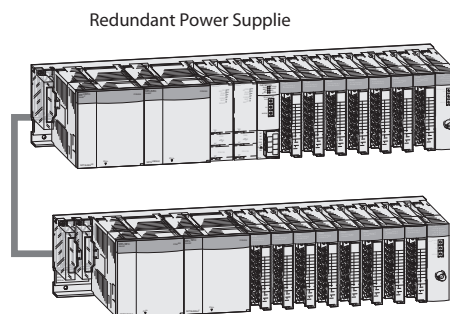
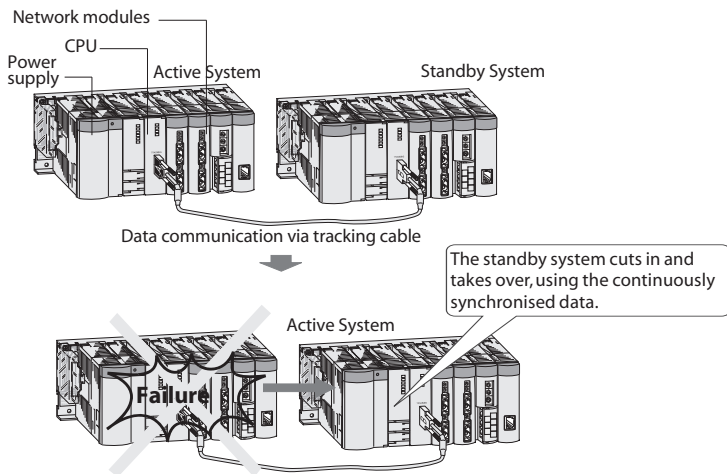

Multiplex Remote System (Standby Master)

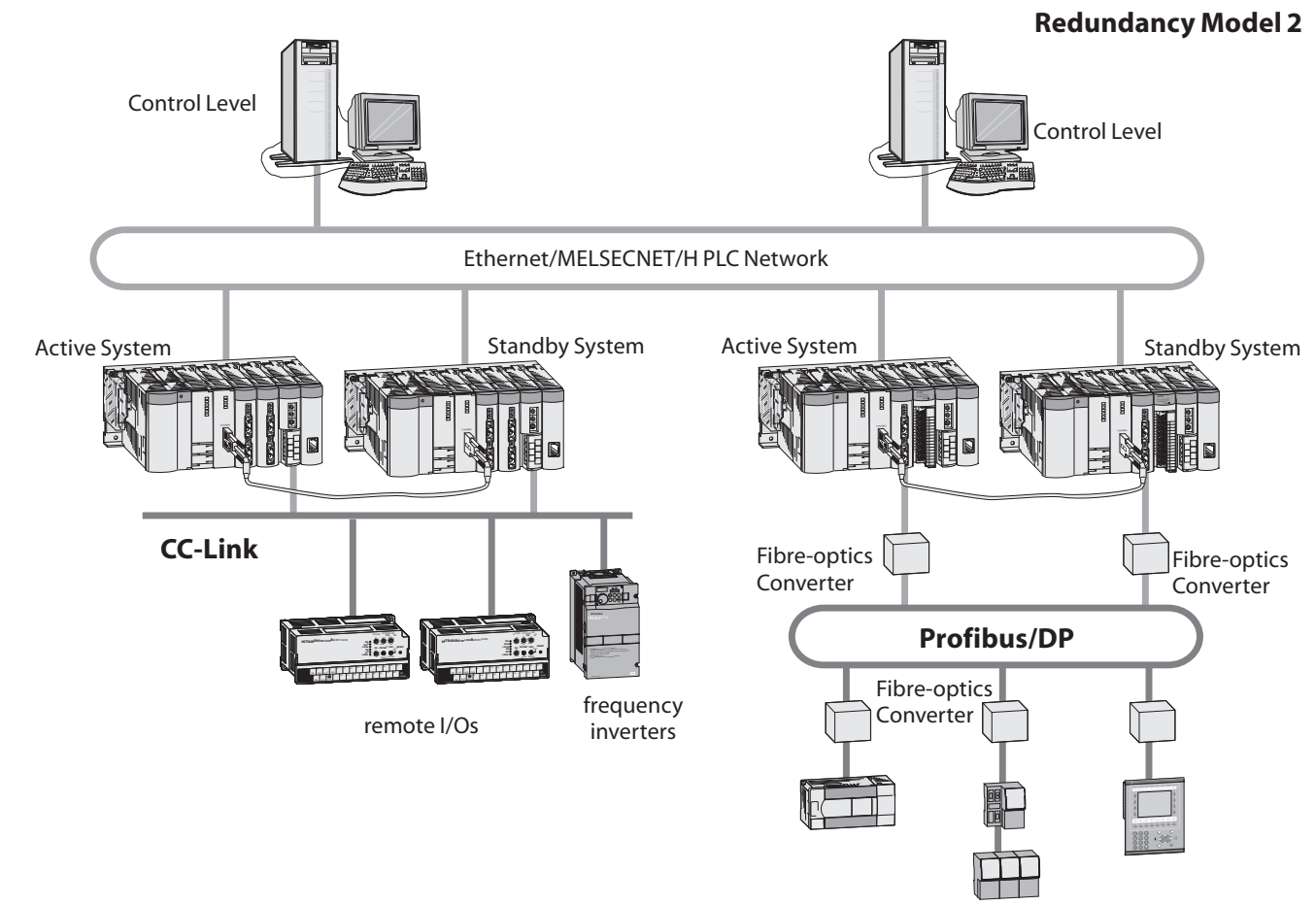
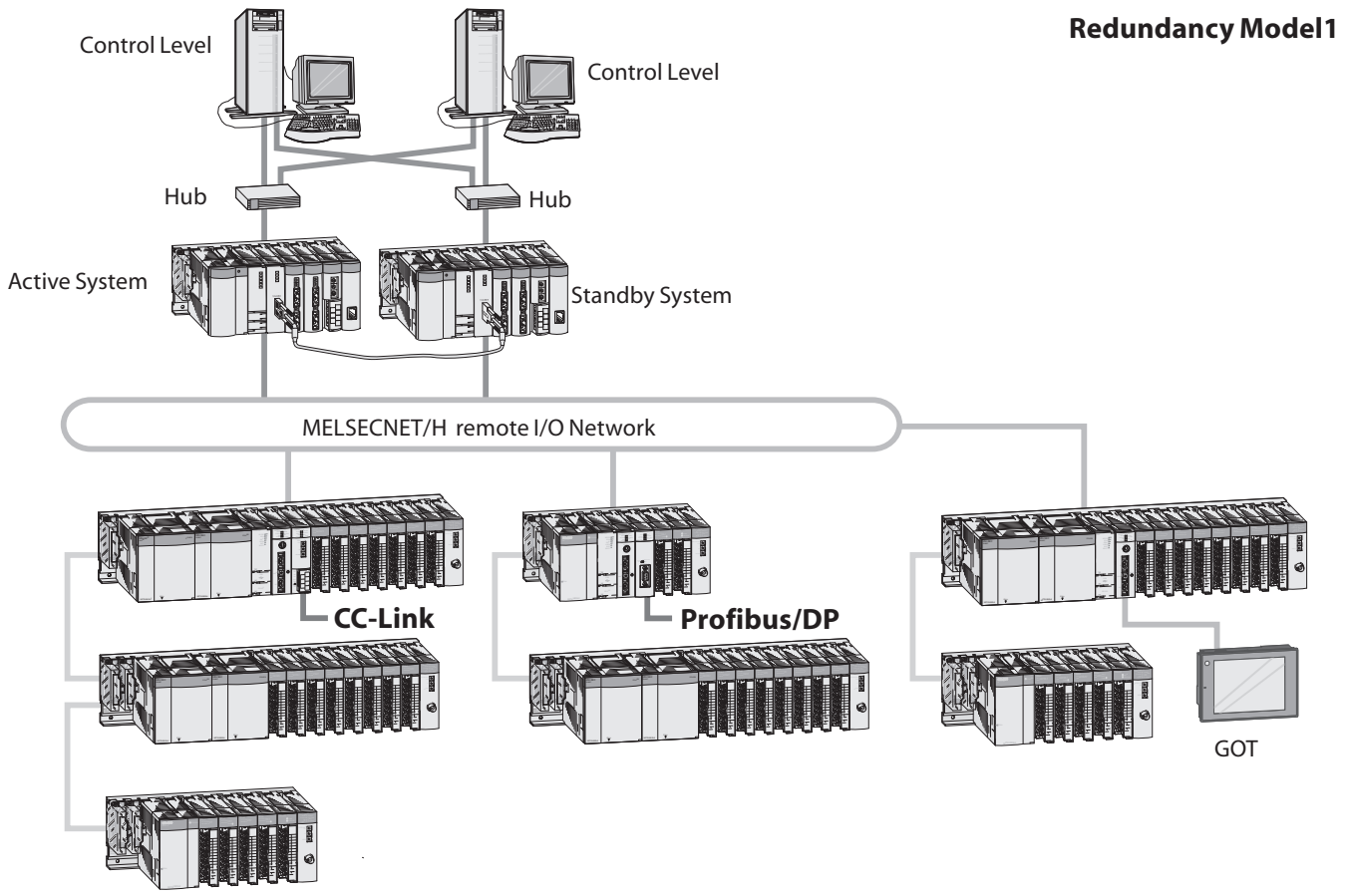

Equipment Features

Owing to the modular concept, the MELSEC system Q has a broad range of use with many possible applications. The following modules are available for assembling the system:

To maximize the operational safety, all modules are isolated from the environment by means of optocouplers. All I/O modules with screw contacts have their own removable terminal blocks which ensures easy handling during installation. The terminal block can be alternatively exchanged for a spring-loaded terminal block (optional).

Use of digital and special function modules

The use of digital and analog modules and most special function modules is dependent only on the maximum addressable number of addresses and thus on the CPU used in each case.

Pulse catch and interrupt modules

Digital input modules for pulse storage and for processing subroutines

Digital input/output modules

for various signal levels with transistor, relay or triac switches

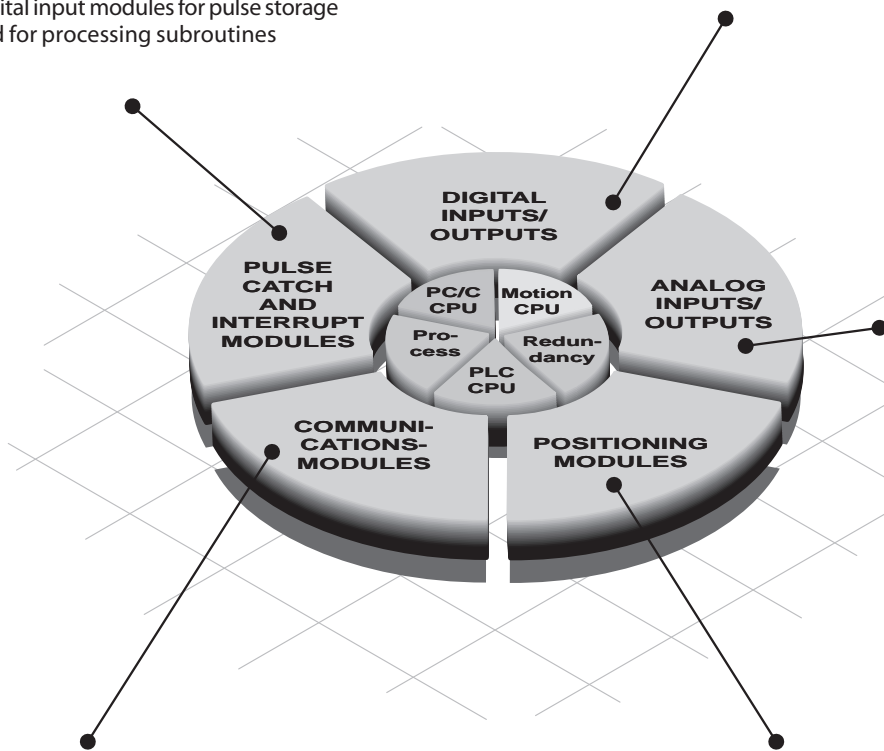

Analog input/output modules
for current/voltage signals and for temperature value acquisition as well as temperature controlling with facility for direct connection of Pt100 resistance thermometers or thermocouples

Communications modules

Interface modules with RS232/RS422/RS485 interface for connection of peripherals or for PLC-PLC coupling.

Network modules for open and proprietary Mitsubishi networks, master modules for the use of remote, analog or digital I/O modules (see also Network Catalogue)

Positioning modules

High-speed counter modules with possibility for connection of incremental shaft encoder or multiaxial positioning modules for servo and step drives with up to 8 axis.

Configuration

System structure

The CPU and modules are held in a base unit which has an internal bus connection for communication between the individual modules and the CPUs. The power for the modules inserted in the base unit is delivered by the power supply module.

The base units are available in 4 different versions with 3 to 12 module slots. Each base unit can be supplemented by means of an extension unit providing additional slots.

If you wish to keep open the option of subsequent extension of your PLC or if you have free slots on your base unit, you can insert dummy modules here. They serve to protect the free slots from soiling or from mechanical effects but can also be used for reserving I/O points.

For cabling larger systems and machines - e.g. in a modular design - the use of remote I/O modules offers additional communications facilities.

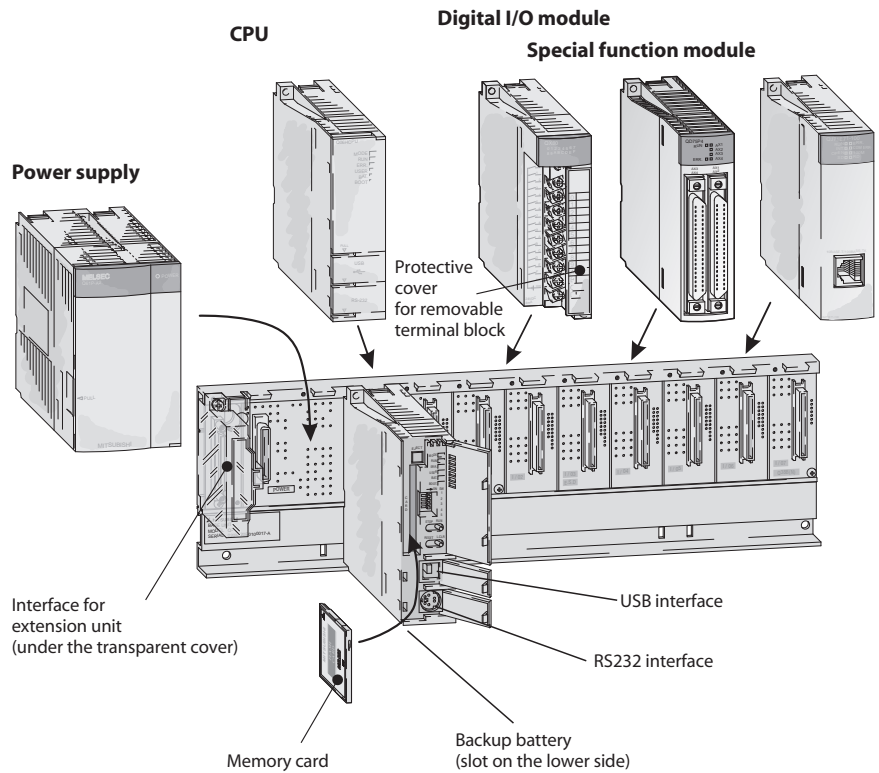

Extension

The base unit and extension units are simply connected to one another by extension cables.

When the Q52B and Q55B are used these cables also supply the necessary 5V DC power supply to the extension base unit.

Up to seven extension units with up to 64 modules can be connected to base units or extension base units. The extension may be in the horizontal or vertical direction and allows a maximum distance of the extensions cables of 13.2 m.

When choosing the power supply module, the total power consumption of the I/O modules, of the special function modules and of the peripherals must be taken into account. If necessary, an extension unit with a further power supply module should be used.

It is also possible to use a redundant power supply configuration to increase availability.

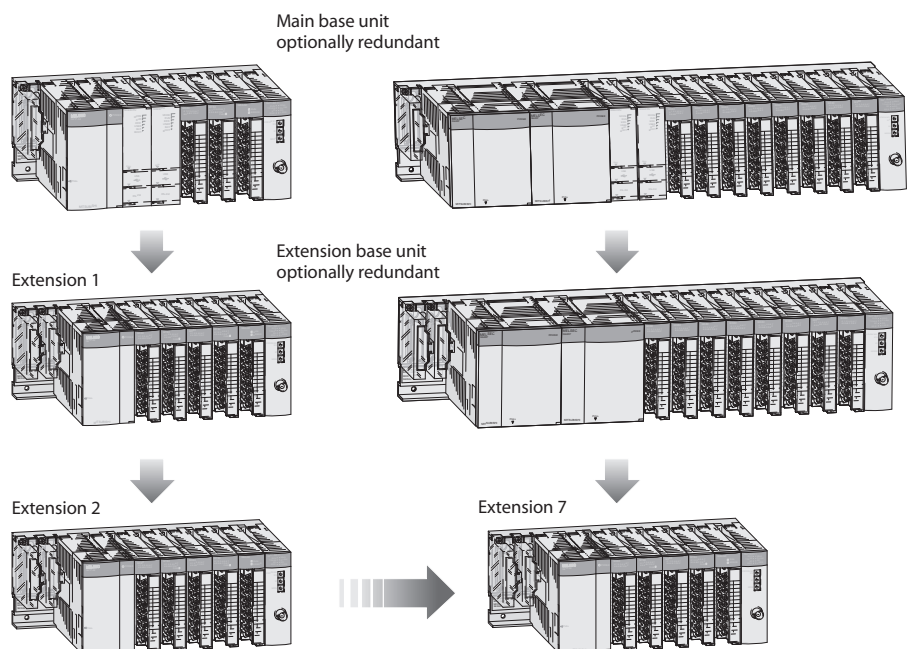

Handling

Mounting the modules

The modules are easily mounted on the base unit with the aid of a guide lug and an optional fixing screw. Installation can thus be carried out quickly and without problems.

If it becomes necessary to change an I/O module, the screw terminal block can be removed beforehand. Thus, it is not necessary to disconnect the entire cabling, but only 2 screws.

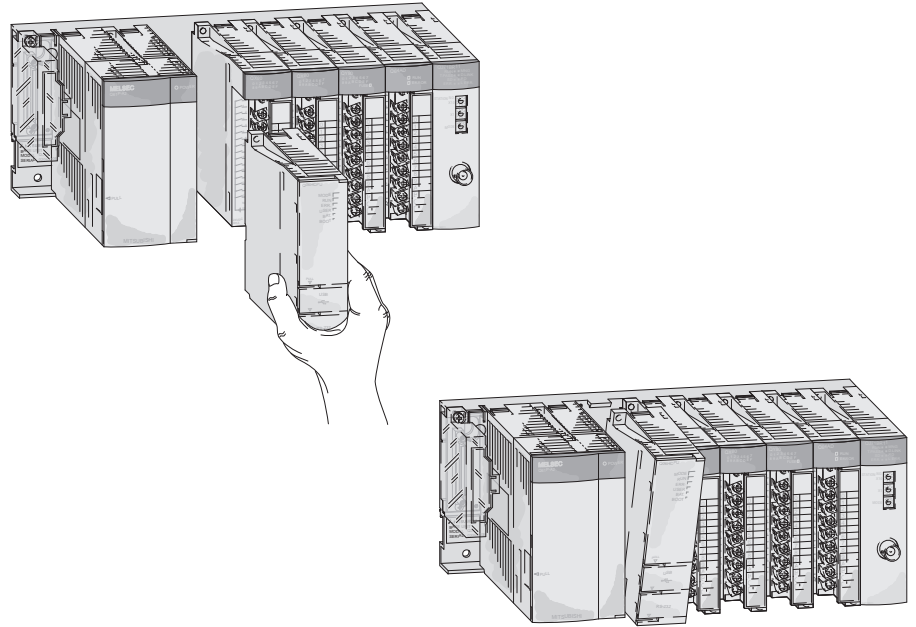

Mounting the base unit

The base unit can be mounted by conventional screw attachments or with a special adapter on a DIN rail.

The individual base units can be mounted either side by side or up to 10 m apart (the length of the extension cables cannot exceed 13.2 metres).

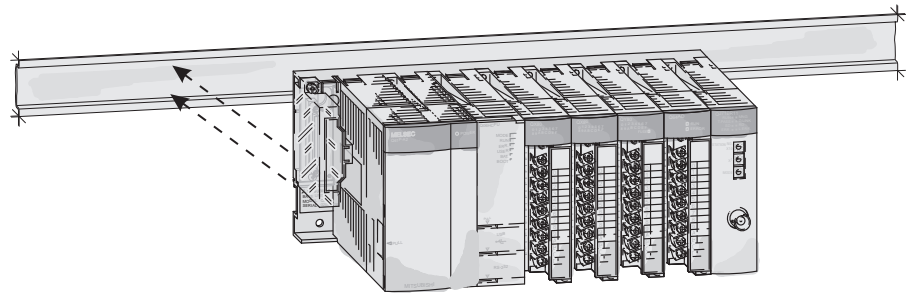

General specifications

General Specifications	Data
Ambient operating temperature	0 – +55 °C
Storage temperature	-25 – +75 °C
Ambient relative humidity	max. 95 % (non-condensing)
Protection	IP 20
Noise durability	1500 Vpp with noise generator; 1 µs at 25 – 60 Hz
Insulation withstand voltage	AC 1500 V, 1 min.
Shock resistance	10 G (3 times each in 3 directions) / EN 61131-2
Vibration resistance	2 G: resistant to vibrations from 10 – 55 Hz for 2 hours along all 3 axes; 0.5 G for DIN rail mounting / EN 61131-2
Insulation resistance	>5 MΩ (500 V DC)
Ground	Class 3
Environment	Avoid environments containing corrosive gases, install in a dust-free location.
Certifications	UL / CSA / CE / DNV / NK / LR / ABS / GL / RINA / BV

MELSEC Networks

TCP/IP ETHERNET

Ready for immediate operation with the worldwide standard TCP/IP protocol. A PC connected to the Ethernet has full access to all PLCs in the Network, all the way down to the I/Os on the production level.

MELSECNET/10/H

Low-cost cabling, brilliantly simple set-up and maximum availability thanks to redundancy and Floating Master. The maximum coverage is up to 30 km.

CC-Link

The network for the control and I/O level comprises capabilities like real-time processing and distributed intelligence. Modules of third-party manufacturers can be integrated.

MELSEC FX Peer-to-Peer

The FX-PPN construction enables a network for up to 8 FX2N controllers as clients. A standard twisted-pair cable can be used as the communications media.

Please refer to the Networks Technical Catalogue for the network modules and accessories for the MELSEC System Q. There you can find further information for the wide network product range of Mitsubishi Electric.

COMMAND LEVEL

TCP/IP ETHERNET

CONTROL LEVEL

CC-Link
MELSECNET/10
MELSECNET/H

PRODUCTION LEVEL

CC-Link
MELSEC FX-PPN

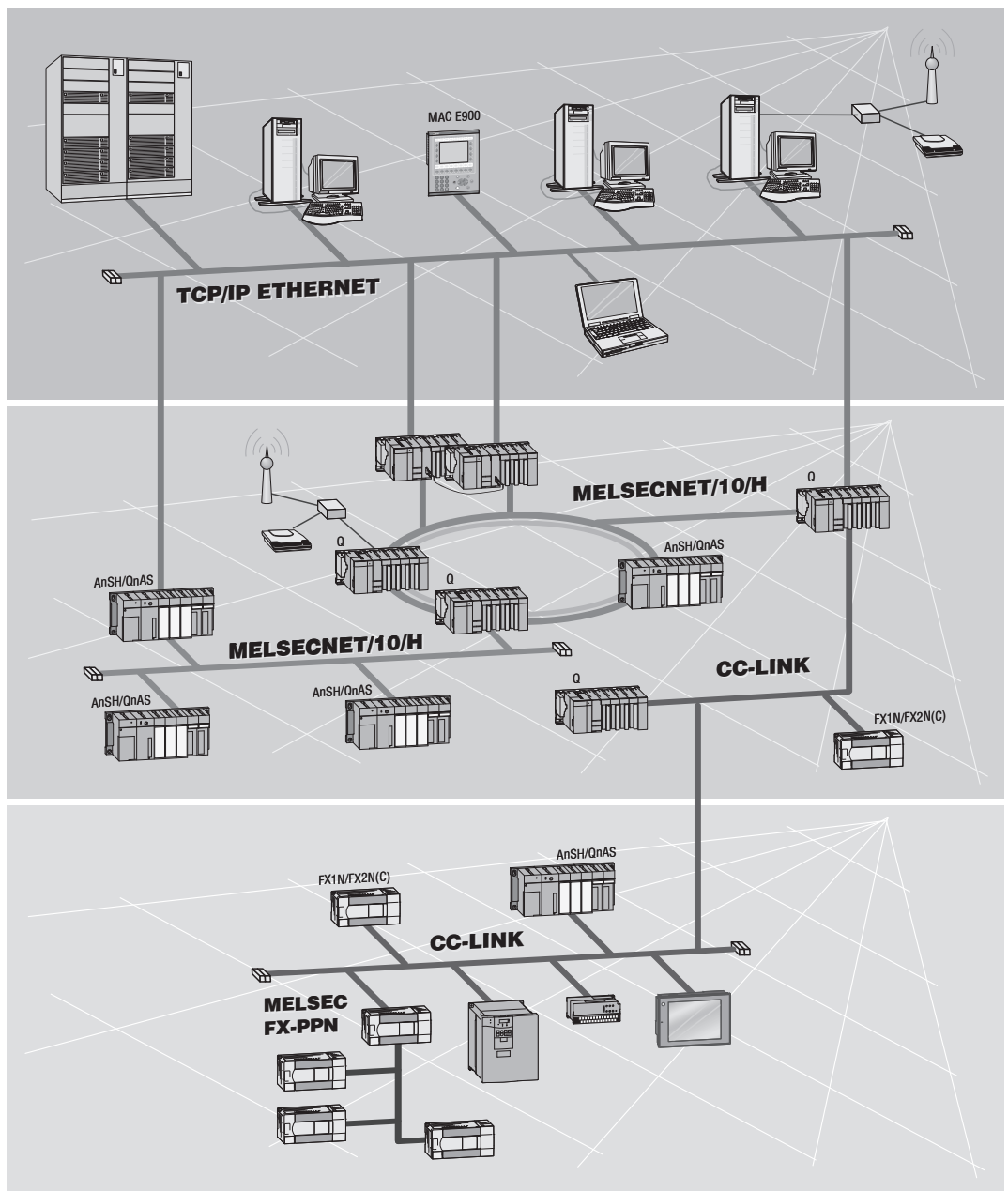

Open Networks

TCP/IP ETHERNET

Ready for immediate operation with the worldwide standard TCP/IP protocol. A PC connected to the Ethernet has full access to all PLCs in the Network, all the way down to the I/Os on the production level.

Modbus/TCP

Non-proprietary protocol using Ethernet, the de facto standard for industrial automation applications

Modbus RTU

Serial protocol for networking master and slaves

CC-Link

The network for the control and I/O level comprises capabilities like real-time processing and distributed intelligence. Modules of third-party manufacturers can be integrated.

Profibus/DP

Enables quick and simple connection of sensors and actuators from different manufacturers to MELSEC PLCs, with data transfer rates of up to 12 Mbaud.

DeviceNet

Cost-effective CAN-based network communications. Fault-resistant network

structure where components of different manufacturers can be integrated quickly and easily.

AS-Interface

International standard for the lowest field bus level. Connection of conventional sensors and actuators with two-core cable.

CANopen

Inexpensive communications network with error-tolerant architecture. Allows fast and simple integration of components from different manufacturers. (FX only)

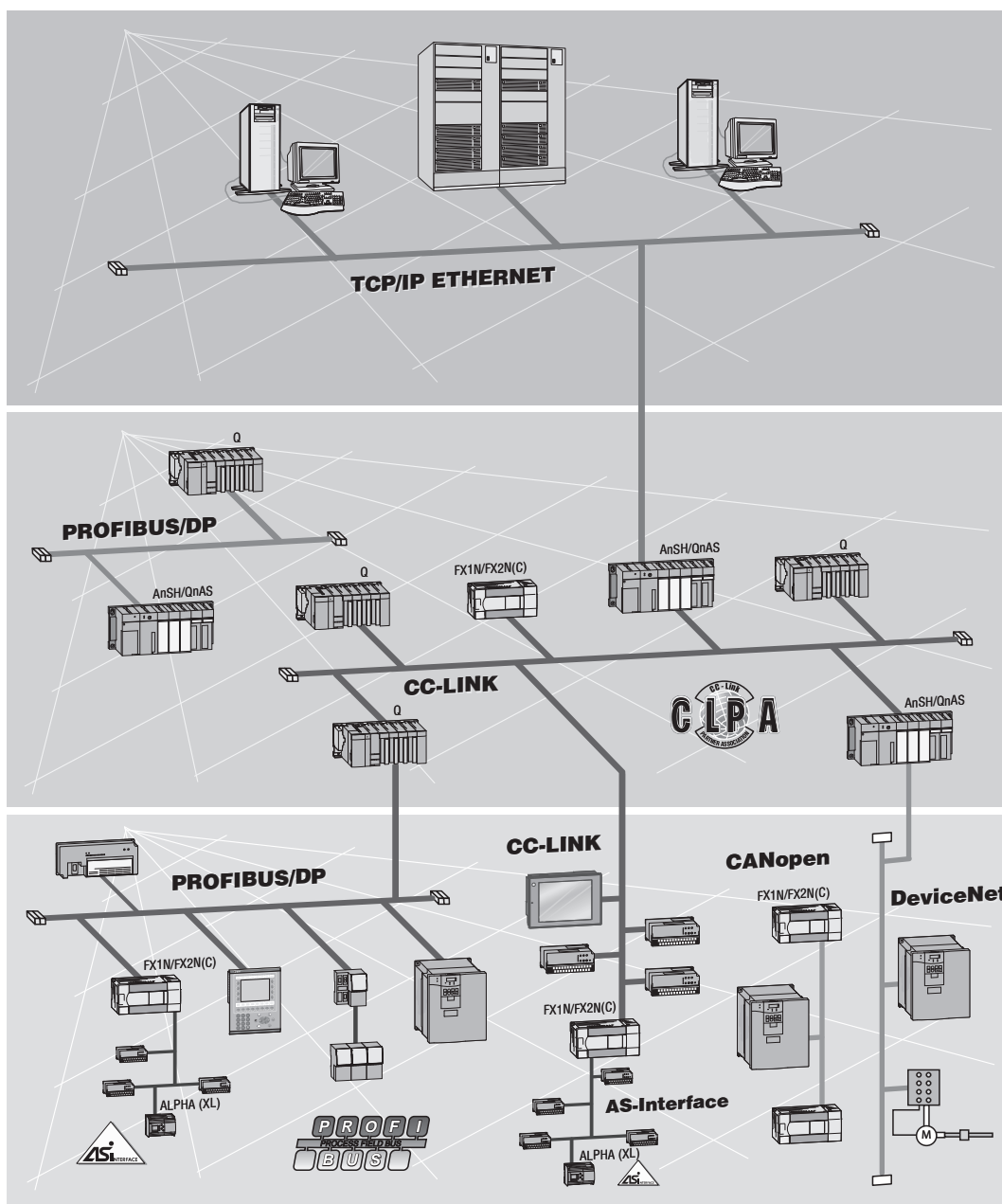

COMMAND LEVEL

TCP/IP ETHERNET

CONTROL LEVEL

Profibus/DP
CC-Link
Modbus/TCP

PRODUCTION LEVEL

Profibus/DP
DeviceNet
AS-Interface
CC-Link
CAN Open
Modbus RTU

■ Main Base Units

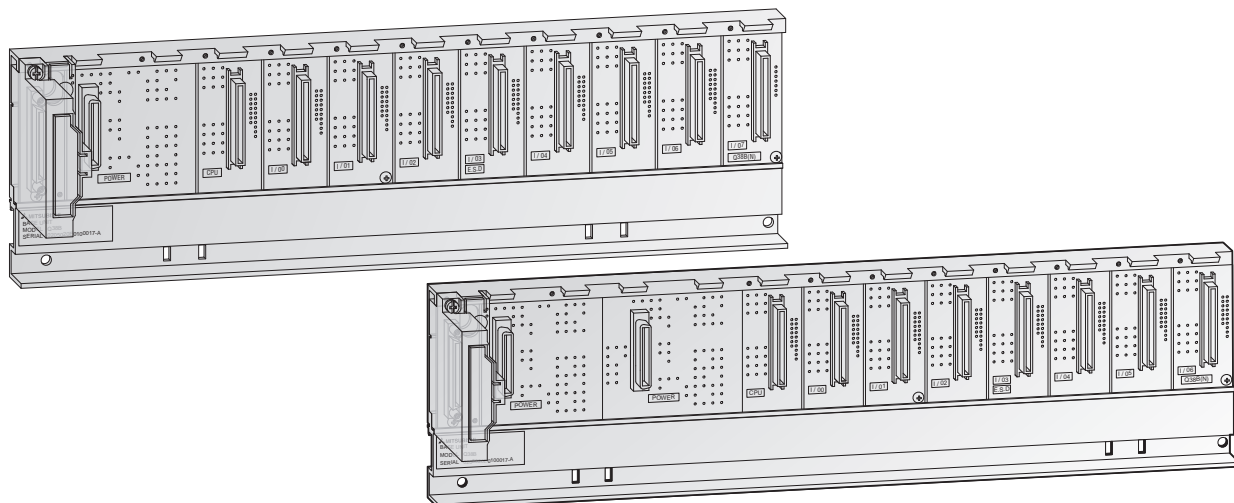

Main base unit

The main base unit is used for holding and coupling CPUs, power supply unit, input modules, output modules, special function modules and field bus connections.

Special features:

- Module addressing is automatic and it is assumed that the base units have 8 slots. Sixteen addresses are assigned to empty slots and non-existent slots (in base units with less than 8 slots). The automatic addressing can be changed with the I/O Assignment function.
- Base units with slots for two redundant power supplies increase the availability of the system.
- The units are mounted by means of screws or on a profiled rail with an integrated adapter.

Specifications	Q33B-E	Q35B-E	Q38B-E	Q38RB-E	Q312B-E	
Slots for power supply modules	1	1	1	2	1	
I/O modules	3	5	8	8	12	
Installation	All base units provide an installation hole $\varnothing 5$ mm and M4 screws.					
Weight	kg	0.21	0.25	0.35	0.45	0.45
Dimensions (W x H x D)	mm	189 x 98 x 44.1	245 x 98 x 44.1	328 x 98 x 44.1	439 x 98 x 44.1	439 x 98 x 44.1
Order information	Art. no.	136369	127586	127624	157573	129566
Accessories	Connection cables (refer to page 36); adapter for DIN rail mounting (refer to page 43)					

■ Extension Base Units

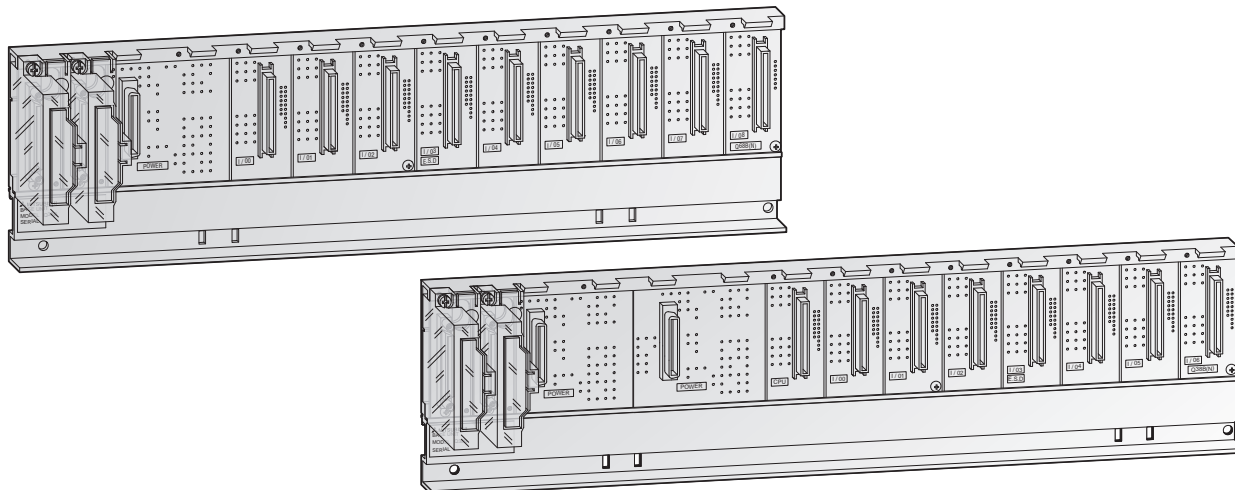

The extension base units are connected to the main base unit by means of assembled bus cables. Thus, a Q system can be expanded to max. 7 extension units with up to 64 I/O modules.

The extension units provide a slot for their own power supply module.

Special features:

- A total of max. 7 extension units can be connected to a base unit.
- The maximum distance from the first to the last base unit is 13.2 m.
- Base units with slots for two redundant power supplies increase the availability of the system.

An extension base unit with a power supply module must be used in the following cases:

- If the power consumption of the inserted modules exceeds the capacity of the power supply module on the base unit.
- If the voltage drops below 4.75 V between the base unit and the extension unit.

Specifications		Q52B	Q55B	Q63B	Q65B	Q68B	Q68RB	Q612B
Slots for power supply modules		—	—	1	1	1	2	1
Slots for I/O modules		2	5	3	5	8	8	12
Installation		All extension units provide an installation hole \varnothing 5 mm and M4 screws.						
Weight	kg	0.14	0.23	0.23	0.25	0.35	0.45	0.45
Dimensions (W x H x D)	mm	106 x 98 x 44.1	189 x 98 x 44.1	189 x 98 x 44.1	245 x 98 x 44.1	328 x 98 x 44.1	439 x 98 x 44.1	439 x 98 x 44.1
Order information	Art. no.	140376	140377	136370	129572	129578	157066	129579
Accessories		Connection cables (refer to page 36); adapter for DIN rail mounting (refer to page 43)						

Power Supply Modules

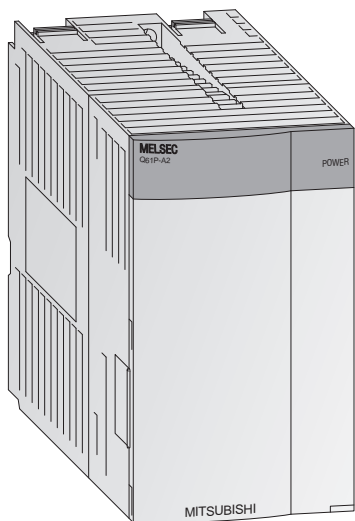

Power supply modules

The power supply modules supply the voltages required for operation to the individual modules. The choice is dependent on the power consumption of the individual modules (this is especially important when using multiple CPUs.)

Special features:

- The readiness for operation is indicated by a LED.
- By use of the power supply Q63P it is possible that controllers can be supplied by means of additional 24 V DC output.
- The power supply modules Q62P can be used world-wide because they support the wide input range from 100 to 240 V AC at 50/60 Hz.
- The Q63RP and Q64RP power supplies can be used with all CPUs (except the Q00JCPU) to increase the system availability level. All redundant power supplies can be replaced while the system is in RUN mode without interrupting control operation.
- Two redundant power supplies in a redundant base unit are required for a redundant power supply configuration.

Specifications		Q61P-A1	Q61P-A2	Q62P	Q63P	Q63RP	Q64P	Q64RP
Input voltage	(+10%, -15%) V AC	100 – 120	200 – 240	100 – 240	—	—	100 – 240	100 – 240
	(+30%, -35%) V DC	—	—	—	24	24	—	—
Input frequency	Hz	50 / 60 (±5 %)	50 / 60 (±5 %)	50 / 60 (±5 %)	—	—	50 / 60 (±5 %)	50 / 60 (±5 %)
Inrush current		20 A within 8 ms	20 A within 8 ms	20 A within 8 ms	81 A within 1 ms	150 A within 1 mss	20 A within 1 ms	20 A within 8 ms
Max. input apparent power		105 VA	105 VA	105 VA	45 W	65 W	160 VA	160 VA
Rated output current	5 V DC	A 6	6	3	6	8.5	8.5	8.5
	24 V DC ±10 %	A —	—	0.6	—	—	—	—
Overcurrent protection	5 V DC	A ≥ 6.6	≥ 6.6	≥ 3.3	≥ 5.5	≥ 5.5	≥ 14.4	≥ 14.4
	24 V DC	A —	—	≥ 0.66	—	—	—	—
Overvoltage protection	5 V DC	V 5.5 – 6.5	5.5 – 6.5	5.5 – 6.5	5.5 – 6.5	5.5 – 6.5	5.5 – 6.5	5.5 – 6.5
Efficiency		≥ 70 %	≥ 70 %	≥ 65 %	≥ 70 %	≥ 65 %	≥ 70 %	≥ 65 %
Insulation withstand voltage	between primary and 5 V DC	2830 V AC, 1 min.	2830 V AC, 1 min.	2830 V AC, 1 min.	500 V AC, 1 min.	500 V AC, 1 min.	2830 V AC, 1 min.	2830 V AC, 1 min.
	between primary and 24 V DC	—	—	2830 V AC, 1 min.	—	—	—	—
Max. compensation time at power failure	ms	20	20	20	10	10	20	20
Power indicator		All modules possess a power LED display.						
Terminal screw size		All modules possess terminal screw size M 3.5 x 7 mm.						
Applicable wire size		0.3 – 2 mm ² (AWG 18–14)	0.3 – 2 mm ² (AWG 18–14)	0.3 – 2mm ² (AWG 18–14)	0.3 – 2 mm ² (AWG 16–22)	0.3 – 2mm ² (AWG 16–22)	0.75 – 2 mm ² (AWG 11–22)	0.75 – 2mm ² (AWG 11–22)
Weight	kg	0.30	0.30	0.39	0.50	0.47	0.40	0.47
Dimensions (W x H x D)	mm	55,2 x 98 x 90	55,2 x 98 x 90	55,2 x 98 x 90	55,2 x 98 x 90	83 x 98 x 115	55,2 x 98 x 115	83 x 98 x 115

■ PLC CPU Modules

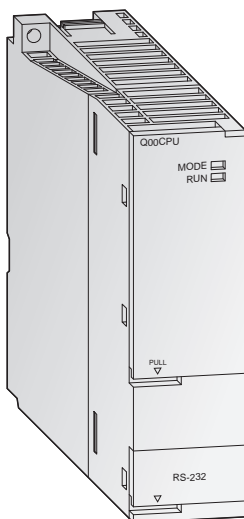

The basic PLC CPUs

The CPU modules of the MELSEC System Q are available as single and multi processor CPUs through which they achieve a wide application range. The performance of the controller here grows with the application by simply replacing the CPU (except Q00J).

While Q00CPU and Q01CPU are classical separate CPUs, the Q00JCPU forms an inseparable unit consisting of CPU, power supply and base unit and thus enables a low-priced entry into the modular PLC technology.

The standard CPUs were developed especially for applications where a compact system configuration easily to be realized is to the fore.

Special features:

- Every CPU is equipped with an RS232C interface for easy programming and monitoring from a personal computer or operating panel.
- Integrated Flash ROMs for memory operation without additional memory cards
- Processing the inputs and outputs with refresh mode

Specifications	Q00JCPU-E	Q00CPU	Q01CPU
Type	Combination of CPU module (single processor), 5 slot base unit and power supply	CPU module (multi processor)	CPU module (multi processor)
I/O points	256/2048	1024/2048	1024/2048
CPU self-diagnostic functions	CPU error detection, Watch Dog, battery error detection, memory error detection, program check, power supply error detection, fuse error detection		
Multi processor operation	Not possible	With PPC-CPU, Q172CPUN, Q173CPUN only	With PPC-CPU, Q172CPUN, Q173CPUN only
Battery buffer	All CPU modules are fitted with a lithium-battery with a life expectancy of 5 years.		
Memory type	ROM	RAM, ROM	RAM, ROM
Memory capacity	overall	94 kByte	94 kByte
	max. for PLC program	8 k steps (32 kByte)	14 k steps (56 kByte)
Program cycle period	0.20 μs/log. instruction	0.16 μs/log. instruction	0.10 μs/log. instruction
Timer (T)	512	512	512
Counter (C)	512	512	512
Internal / special relay (M)	8192	8192	8192
Data register / special register (D)	11136	11136	11136
File register (R) ①	—	32768	32768
Interrupt pointer (I)	128	128	128
Pointer (P)	300	300	300
Annunciator (F)	1024	1024	1024
Index register (Z)	10	10	10
Link relay (B) / link register (W)	2048 / 2048	2048 / 2048	2048 / 2048
Number of connectable extensions	2	4	4
Max. number of insertable modules	16	24	24
Internal power consumption (5 V DC)	220 mA	250	270
Weight	0.66 ② kg	0.13	0.13
Dimensions (W x H x D)	245 x 98 x 98 ② mm	27.4 x 98 x 89.3	27.4 x 98 x 89.3
Order information	Art.no. 140378	138323	138324
Accessories	—		

① Number depends on memory configuration. ② All specifications refer to the entire unit incl. base unit and power supply unit.

PLC CPU Modules

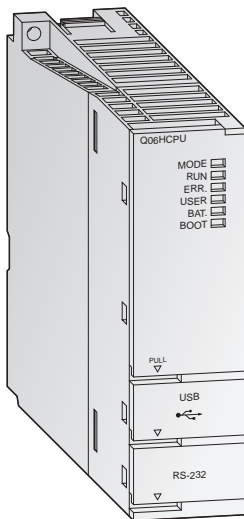

High-performance PLC CPUs

With the high-performance CPUs a high processing speed and expandability are to the fore. They provide a great variety of functions and an even optimized programming and debugging environment to ensure a flexible response to all systems.

The two process CPU models Q12PHCPU and Q25PHCPU have extended control functions with two degrees of freedom, PID cascading and autotuning. These processors also feature a set of 52 process instructions and support an unlimited number of PID loops.

Special features:

- Every multi processor H-CPU is equipped with an USB interface for easy programming and monitoring from a personal computer.
- Processing the inputs and outputs with refresh mode
- Floating point arithmetic according to IEEE 754
- Special statements for processing PID control loops
- Mathematical functions, such as angle/exponential functions and logarithm
- Hot-swap module replacement in RUN mode (with process CPUs)
- Multi processor mode is possible with up to 4 CPU modules.

Specifications	Q02CPU	Q02HCPU	Q06HCPU	Q12HCPU	Q25HCPU	Q12PHCPU	Q25PHCPU	
Type	Multi processor CPU module					Process CPU module		
I/O points	4096/8192	4096/8192	4096/8192	4096/8192	4096/8192	4096/8192	4096/8192	
CPU self-diagnostic functions	CPU error detection, Watch Dog, battery error detection, memory error detection, program check, power supply error detection, fuse error detection							
Multiprocessor mode	Up to 4 CPU modules can be used in combination on one base unit.							
Battery buffer	All CPU modules are fitted with a lithium-battery with a life expectancy of 5 years.							
Memory type	RAM, ROM, FLASH	RAM, ROM, FLASH	RAM, ROM, FLASH	RAM, ROM, FLASH	RAM, ROM, FLASH	RAM, ROM, FLASH	RAM, ROM, FLASH	
Memory capacity	overall	≤ 32 MByte	≤ 32 MByte	≤ 32 MByte	≤ 32 MByte	≤ 32 MByte	≤ 32 MByte	
	max. for PLC program	28 k steps (112 kByte)	28 k steps (112 kByte)	60 k steps (240 kByte)	124 k steps (496 kByte)	252 k steps (1008 kByte)	252 k steps (1008 kByte)	
Program cycle period	79 ns/ log. instruction	34 ns/ log. instruction	34 ns/ log. instruction	34 ns/ log. instruction	34 ns/ log. instruction	34 ns/ log. instruction	34 ns/ log. instruction	
Timer (T)	2048	2048	2048	2048	2048	2048	2048	
Counter (C)	1024	1024	1024	1024	1024	1024	1024	
Internal / special relay (M)	8192	8192	8192	8192	8192	8192	8192	
Data register / special register (D)	12288	12288	12288	12288	12288	12288	12288	
File register (R) ①	32768 / max. 1042432	65536 / max. 1042432	65536 / max. 1042432	131072 / max. 1042432	131072 / max. 1042432	131072 / max. 1042432	131072 / max. 1042432	
Interrupt pointer (I)	256	256	256	256	256	256	256	
Pointer (P)	4096	4096	4096	4096	4096	4096	4096	
Annunciator (F)	2048	2048	2048	2048	2048	2048	2048	
Index register (Z)	16	16	16	16	16	16	16	
Link relay (B) / link register (W)	8192 / 8192	8192 / 8192	8192 / 8192	8192 / 8192	8192 / 8192	8192 / 8192	8192 / 8192	
Number of connectable extensions	7	7	7	7	7	7	7	
Max. number of insertable modules	64	64	64	64	64	64	64	
Internal power consumption (5 V DC)	mA 600	640	640	640	640	640	640	
Max. compensation time at power failure	ms	Varies according to the type of power unit						
Weight	kg 0.20	0.20	0.20	0.20	0.20	0.20	0.20	
Dimensions (W x H x D)	mm 27.4 x 98 x 89.3	27.4 x 98 x 89.3	27.4 x 98 x 89.3	27.4 x 98 x 89.3	27.4 x 98 x 89.3	27.4 x 98 x 89.3	27.4 x 98 x 89.3	
Order information	Art.no.	132561	127585	130216	130217	130218	143529	143530
Accessories		Memory cards (refer to page 45)				Software PX-Developer optional		

① Number depends on memory configuration

■ Redundant PLC CPU Modules

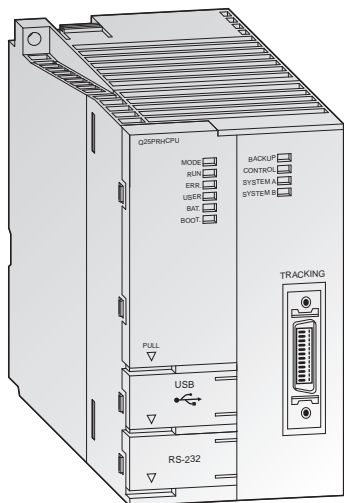

Redundant PLC CPU Modules

In a redundant setup two identically-configured systems are automatically kept synchronised to provide “hot standby” functionality, thus guaranteeing maximum availability and failsafe performance. This significantly reduces down time and restart overheads and costs. The higher purchase price of redundant systems are negligible when compared to the costs they can save in the event of a failure.

If the active system fails the hot standby system cuts in automatically and takes over, without any interruption.

The system’s modular architecture makes it possible to implement different levels of redundancy, as required: Power supply redundancy, master redundancy and controller redundancy.

Special features:

- QnPRH is based on standard components, so existing peripherals can be used.
- Complete integration in existing and non-redundant environments possible.
- Very short switching times possible – user-configurable, min. switching time 22ms (48k words).
- Programmable just like a normal system, using standard software.
- Automatic detection of the active system with MX Components/MX OPC Server communicating with higher-level systems
- Connection of peripherals via redundant ring MELSECNET, CC-Link and Profibus with or without master redundancy possible.

Specifications	Q12PRHCPU	Q25PRHCPU
Type	Process CPU module, high availability	
I/O points	4096/8192	4096/8192
CPU self-diagnostic functions	CPU test, watchdog (time monitoring), battery check, memory test, program plausibility, mains power monitoring, redundancy synchronisation	
Multiprocessor mode	—	
Battery buffer	All CPUs are fitted with a lithium battery with a service life of 5 years.	
Memory type	RAM, ROM, FLASH	RAM, ROM, FLASH
Memory capacity	overall	≤ 32 MByte
	max. for PLC program	124 k steps (496 kByte)
Program cycle period	34 ns/log. instruction	34 ns/log. instruction
Timer (T)	2048	2048
Counter (C)	1024	1024
Internal / special relay (M)	8192	8192
Data register / special register (D)	12288	12288
File register (R)	131072 / max. 1042432	131072 / max. 1042432
Interrupt pointer (I)	256	256
Pointer (P)	4096	4096
Annunciator (F)	2048	2048
Index register (Z)	16	16
Link relay (B) / link register (W)	8192 / 8192	8192 / 8192
Max. number of insertable modules	Max 11 in main base unit, 64 all via MELSECNET remote connection, no central extension unit can be connected	
Internal power consumption (5 V DC)	mA 640	640
Weight	kg 0,30	0,30
Dimensions (W x H x D)	mm 52.2 x 98 x 89.3	52.2 x 98 x 89.3
Order information	Art.no. 157070	157071
Accessories	Software PX-Developer (optional)	

*Tracking cables QC10TR and QC30TR, refer to page 43

PC CPU Module

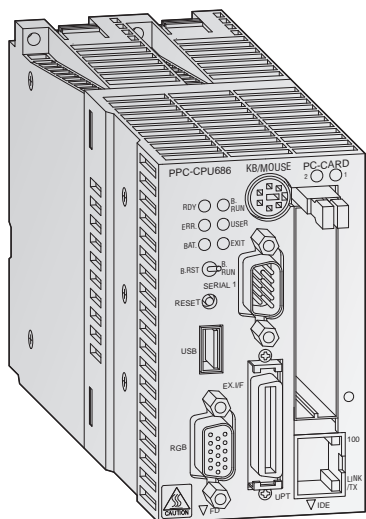

The personal computer for the base unit

The PC CPU module is a compact personal computer of high value which can be installed on the main base unit. Here the Q-PC masters PC typical applications as well as PLC applications. Therefore, it is suitable as an integrated PC within control systems - e.g. for visualization, data bases, and log-trace functions of the Microsoft application or for programming the System Q in a high-level language. In addition, the system can be controlled as soft PLC according to IEC1131 via the optional SX-Controller software. For the connection to the peripherals I/O and special function modules from the MELSEC System Q can be used.

Special features:

- Employing with low power consumption and high speed Intel CPU (600 MHz), enabling processing of a large amount of data at high speed
- Windows 2000 operating system supported (XP version also possible on request)
- Capable of connecting silicon disk units for use in a place subject to vibration and shock
- Outstanding noise immunity
- Fan-less operation and suitable for clean-room applications
- Control of a complete system in a high-level language such as C++ or Visual Basic supported

Specifications		PPC-CPU 852(MS)-512	
Type	Personal Computer CPU		
CPU	Ultra low voltage Intel® Celereon® M processor (FSB 400 MHz)		
Processing frequency	MHz	600	
Memory	512 MB (main) / 2 x 32 kB L1 (cache), 1 x 512 kB L22 (cache)		
Video	Integrated graphics board for a maximum resolution of 1280 x 1024 pixels, 16 mio. colours		
Interfaces	serial (RS232C)	2 (1 integrated 9-pin D-SUB connector and 1 optional interface at the extension box which is connected to "EX I/F")	
	parallel	1	
	USB	4 (3 integrated 9-pin D-SUB connector and 1 optional interface at the extension box which is connected to "EX I/F")	
	keyboard/mouse	1 x PS/2 connector (keyboard and mouse can be used at the same time with the conversion cable PPC-YCAB-01.)	
	LAN	1 x ETHERNET interface (100BASE-TX/10BASE-T)	
	monitor	1 x 15-pin H-DSUB	
Connections for drives	1 x disk drive, 2 x hard disk (silicon hard disks are supported)		
PC card slots	2 PCMCIA, CardBus		
No. of occupied I/O points	4096/8192		
Internal power consumption (5 V DC)	mA	3000	
Weight	kg	0.47	
Dimensions (W x H x D)	mm	55.2 x 98 x 115	
Order information	PPC-SET-Nil	art. no.: 207875	set with 1 x PC CPU module; 512 MB RAM, no hard disk, driver PPC-DRV-02, without operating system
	PPC-SET-Win 2000	art. no.: 207876	set with 1 x PC CPU module; 512 MB RAM, 20 GB hard disk, driver PPC-DRV-02, operating system Windows 2000
	PPC-SET-WinXp pro	art. no.: 207877	set with 1 x PC CPU module; 512 MB RAM, 20 GB hard disk, driver PPC-DRV-02, operating system Windows XP pro
	PPC-SET-WinXp lmb	art. no.: 207878	set with 1 x PC CPU module; 512 MB RAM, 20 GB hard disk, driver PPC-DRV-02, operating system Windows XP lmb
Accessories	Additional hard disks, external drives, cables etc. (refer to page 48); Soft PLC for the Q PC CPU: SX-Controller for Windows NT/2000 without realtime environment (SX-Controller V0100-1LOC-E, art. no.: 144006)		

C-Controller CPU

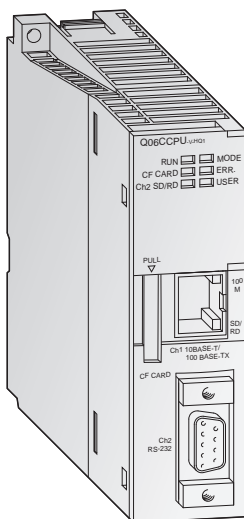

High-level language programming in combination with real time operating system

The C-Controller allows the integration and programming of the automation platform System Q with C++. Using the worldwide established real time operating system VxWorks, realisation of complex tasks, communication and protocols becomes easy.

Special features:

- Integration in the multi CPU layout of System Q through combination with PLC and Motion CPUs or use as stand-alone system.
- Real time operating system VxWorks
- Dedicated development environment of C-/C++ language is "Tornado" by Wind River Systems
- 1 GB Compact Flash card makes handling of large quantities of data easy
- High performance addition to the existing range of automation products
- Ethernet and RS-232 interface on board
- Real time OS VxWorks and Telnet pre-installed
- Standard C/C++ Code can be embedded
- Remote access via networks und support of FTP
- VxWorks communication library and QBF libraries for easy setup
- CoDeSys compatibility

Specifications	Q06CCPU-V-H01
Number of I/Os	4096 (X/Y0 – X/YFFF)
Memory	Standard ROM: 16 MB (user area: 6 MB); Work RAM: 32 MB (user area: 14 MB); Battery-backed-up RAM: 128 kB
Operating system	VxWorks Version 5.4 (preinstalled)
Programming language	C or C++
Development tool	Tornado 2.1 (licenses with special conditions for Mitsubishi users are available directly from Wind River)
Communication interfaces	RS232 (1 ch.), 10BASE-T/100BASE-TX (1 ch.)
Data format	1 start bit, 7 or 8 data bits, 1 or 0 parity bits, 1 or 2 stop bits
Parity check	Parity checking can be activated by the user
Checksum	Checksum can be activated by the user
Data communications control	By control of the RS and CS signals (user-configurable)
Connection of external wiring	9-pin SubD (RS-232), RJ45 (Ethernet)
CF card I/F	1 slot for a TYPE I card (Max 1 GB CF card is supported)
Integrated clock	Year, month, day, minute, second, weekday (automatic leap year adjustment)
Max. compensation time at power failure	Depends on power supply
Internal power consumption (5 V DC)	0.71A
Weight	kg 0.17
Dimensions (W x H x D)	mm 27.4 x 98 x 89.3
Order information	Art. no. 165353
Accessories	Programming via Ethernet, cross-link cable (X-Link) may be required. Programming software C-Controller Configurator V0100-1LOC-E; art. no. 165367 A special development suite (Tornado, WindView, Sniff+) for the Q06CCPU is available worldwide from any Wind River branch, just quote our contract no. 209356. A free demo version is available for testing.

■ Motion CPU Modules

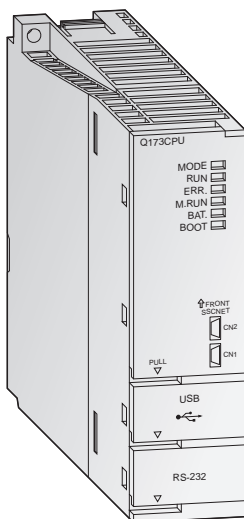

The high-speed dynamic motion CPU

The motion controller CPU controls and synchronizes the connected servo amplifiers and servo motors. A motion system besides the controller CPU as well includes a PLC CPU. Only after combining a highly dynamic positioning control and a PLC an innovative and autarkical motion control system is created.

While the Motion CPU controls large-scale servo movements the PLC CPU is responsible for the machine control and the communication at the same time.

Special features:

- Using multiple CPUs to distribute the load improves the overall performance of the whole system
- Use of up to 3 motion CPUs within one system
- Large scale control system for up to 96 axes per system
- Interpolation of 4 axes simultaneously
- Software cam control
- Virtual and real master axes
- Integration in the high-speed SSCNET network for communication with high-performance servo amplifiers at up to 5.6 Mbit/s

Specifications	Q172CPUN	Q172HCPU	Q172HCPU-T	Q173CPUN	Q173HCPU	Q173HCPU-T	
Type	Motion CPU	Motion-CPU	Motion-CPU	Motion CPU	Motion-CPU	Motion-CPU	
I/O points	8192	8192	8192	8192	8192	8192	
No. of control axes	8	8	8	32	32	32	
Interpolation functions	Linear interpolation for up to 4 axes, circular interpolation for 2 axes, helical interpolation for 3 axes						
Positioning	method	PTP (point to point), speed control/speed-position control, fixed pitch feed, constant speed control, position follow-up control, speed switching control, high-speed oscillation control, synchronous control (SV22)					
	acceleration/deceleration control	Automatic trapezoidal acceleration/deceleration, S-curve acceleration/deceleration					
	compensation	Backlash compensation, electronic gear					
Programming language	Motion SFC, dedicated instructions, software for conveyor assembly (SV13), virtual mechanical support language (SV22)						
Processing speed	SV13	0.88 ms (1. – 8. axis)			0.88 ms (1. – 8. axis), 1.77 ms (9. – 16. axis), 3.55 ms (17. – 32. axis)		
	SV22	0.88 ms (1. – 4. axis), 1.77 ms (5. – 8. axis)			0.88 ms (1. – 4. axis), 1.77 ms (5. – 12. axis), 3.55 ms (13. – 24. axis), 7.11 ms (25. – 32. axis)		
Program capacity	14 k steps						
No. of positioning points	3200						
Program execution	number of multi executed programs	Max. 256					
	number of multi active steps	Max. 256 steps in all programs					
	executed tasks	normal	Executed in motion main cycle				
		interrupt	Executed in fixed cycles (0.88 ms, 1.7 ms, 3.5 ms, 7.1 ms, 14.2 ms) 16 external interrupt points (Q160 interrupt module inputs), executed with interrupt from PLC CPU (when executing the S(P).GINT instruction)				
NMI	16 points; executed when input ON is set among an interrupt module (e.g. Q160)						
Interfaces	USB, RS232C, SSCNET	USB, RS232C, SSCNET	USB, RS232C, SSCNET, Teaching Uni	USB, RS232C, SSCNET	USB, RS232C, SSCNET	USB, RS232C, SSCNET, Teaching Unit	
Real I/O points (PX/PY)	256 (these I/Os can be allocated directly to the motion CPU)			256 (these I/Os can be allocated directly to the motion CPU)			
Certifications	—	CE, UL & cUL	CE, UL & cUL	—	CE, UL & cUL	CE, UL & cUL	
Internal power consumption (5 V DC)	A 1.62	1.62	1.62	1.75	1.75	1.75	
Weight	kg 0.25	0.25	0.25	0.25	0.25	0.25	
Dimensions (W x H x D)	mm 27.4 x 98 x 114.3	27,4 x 98 x 89,3	27,4 x 98 x 89,3	27.4 x 98 x 114.3	27.4 x 98 x 114.3	27.4 x 98 x 114.3	
Order information	Art. no. 142695	162417	162419	142696	162416	162418	
Accessories	Manual pulse generator, encoder, interface module (for detailed informations please refer to the technical catalogue "Motion Controller System Q".)						

Digital Input Modules

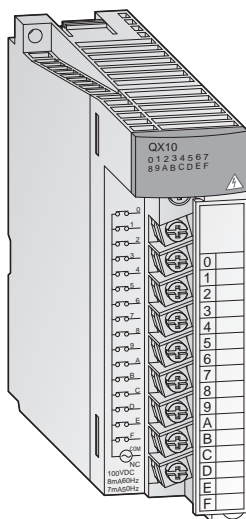

Detection of process signals

Various input modules are available for converting the digital process signals with different voltage levels into the levels required by the PLC.

Special features:

- Potential isolation between process and control by means of an optocoupler is a standard feature.
- Indication of input status via LEDs
- Modules with 16 connection points have removable terminal blocks with screws.
- Assembled cables are available for modules with plugs (Q32CBL: 3 m or 5 m; Q40CBL: 3 m or 5 m).
- Different system terminals for module wiring simplification are available (refer to page 39)

Specifications		QX10	QX28	QX40	QX40-S1	QX41	QX41-S1	QX42	QX42-S1
Input points		16	8	16	16	32	32	64	64
Insulation method		Photocoupler isolation between input terminals and PC power for all modules.							
Rated input voltage		100 – 120 V AC (50 / 60 Hz)	100 – 240 V AC (50/60 Hz)	24 V DC	24 V DC	24 V DC	24 V DC	24 V DC	24 V DC
Operating voltage range		V 85 – 132	85 – 264	20.4 – 28.8	20.4 – 28.8	20.4 – 28.8	20.4 – 28.8	20.4 – 28.8	20.4 – 28.8
Max. simultaneously ON ^③ (at rated voltage)		100 % ^②	100 %	100 % (sink type)	100 % (sink type)	100 % (sink type)	100 % (sink type)	100 % ^② (sink type)	100 % ^② (sink type)
Inrush current		200 mA for 1 ms (at 132 V AC)	200 mA for 1 ms (at 132 V AC)	—	—	—	—	—	—
Rated input current		mA 7 (100 V AC, 50 Hz), 8 (100 V AC, 60 Hz)	7 (100 V AC, 50 Hz), 8 (100 V AC, 60 Hz), 14 (200 V AC, 50 Hz), 17 (200 V AC, 60 Hz)	approx. 4	approx. 6	approx. 4	approx. 4	approx. 4	approx. 4
ON	voltage	V ≥ AC 80	≥ AC 80	≥ DC 19	≥ DC 19	≥ DC 19	≥ DC 19	≥ DC 19	≥ DC 19
	current	mA ≥ AC 5	≥ AC 5	≥ DC 3	≥ DC 4	≥ DC 3	≥ DC 4	≥ DC 3	≥ DC 3
OFF	voltage	V ≤ AC 30	≤ AC 30	≤ DC 11	≤ DC 11	≤ DC 11	≤ DC 9.5	≥ DC 11	≥ DC 9.5
	current	mA ≤ AC 1	≤ AC 1	≤ DC 1.7	≤ DC 1.7	≤ DC 1.7	≤ DC 1.5	≥ DC 1.7	≥ DC 1.5
Load resistance		kΩ approx. 18 (50 Hz) approx. 15 (60 Hz)	approx. 15 (50 Hz) approx. 12 (60 Hz)	approx. 5.6	approx. 3.9	approx. 5.6	approx. 5.6	approx. 5.6	approx. 5.6
Response time	OFF → ON	ms ≤ 15 (100 V AC, 50/60 Hz)	≤ 15 (100 V AC, 50/60 Hz)	1 – 70 ^①	0.05 – 1.2 ^①	1 – 70 ^①	0.05 – 1.2 ^①	1 – 70 ^①	0.05 – 1.2 ^①
	ON → OFF	ms ≤ 20 (100 V AC, 50/60 Hz)	≤ 20 (100 V AC, 50/60 Hz)	1 – 70 ^①	0.15 – 1.3 ^①	1 – 70 ^①	0.15 – 1.3 ^①	1 – 70 ^①	0.05 – 1.3 ^①
Common terminal arrangement		16	8	16	16	32	32	32	32 x 2
Power indicator		All modules possess a status LED per input/output.							
Connection terminal		18-point removable terminal block	18-point removable terminal block	18-point removable terminal block	18-point removable terminal block	40-pin connector	40-pin connector	Two 40-pin connectors	Two 40-pin connectors
No. of occupied I/O points		16	16	16	16	32	32	64	64
Applicable wire size		mm ² 0.3 – 0.75	0.3 – 0.75	0.3 – 0.75	0.3 – 0.75	0.3	0.3	0.3	0.3
Internal power consumption (5 V DC)		mA 50 (all input points ON)	50 (all input points ON)	50 (all input points ON)	60 (all input points ON)	75 (all input points ON)	75 (all input points ON)	90 (all input points ON)	90 (all input points ON)
Weight		kg 0.17	0.20	0.16	0.20	0.15	0.15	0.18	0.18
Dimensions (W x H x D)		mm 27.4 x 98 x 90	27.4 x 98 x 90	27.4 x 98 x 90	27.4 x 98 x 90	27.4 x 98 x 90	27.4 x 98 x 90	27.4 x 98 x 90	27.4 x 98 x 90
Order information		Art. no. 129581	136396	132572	136574	132573	146921	132574	146922
Accessories		40-pin connector and ready to use connection cables and system terminals (refer to page 42–44); Spring clamp terminal block for exchange against the standard screw terminal block (refer to page 47);							

① CPU parameter setting (default setting: 10 ms) ② at 45 °C ③ Please refer to page 51 for diagrams showing the simultaneously switchable inputs.

Digital Input Modules

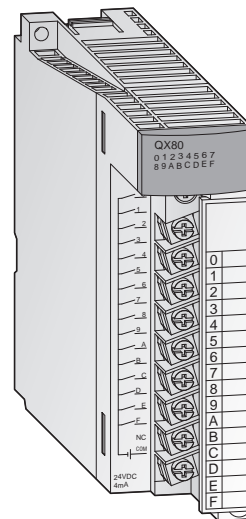
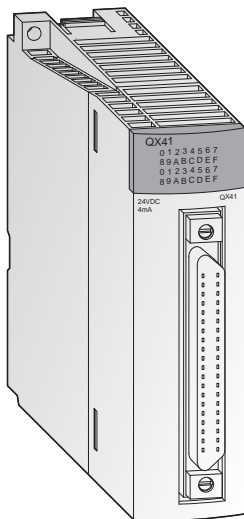

Specifications	QX50	QX70	QX71	QX72	QX80	QX81	QX82	QX82-51
Input points	16	16	32	64	16	32	64	64
Insulation method	Photocoupler isolation between input terminals and PC power for all modules.							
Rated input voltage	48 V DC	5 – 12 V DC	5 – 12 V DC	5 – 12 V DC	24 V DC	24 V DC	24 V DC	24 V DC
Operating voltage range	V 40.8 – 52.8	4.25 – 14.4	4.25 – 14.4	4.25 – 14.4	20.4 – 28.8	20.4 – 28.8	20.4 – 28.8	20.4 – 28.8
Max. simultaneously ON ^③ (at rated voltage)	100 %	100 %	100 %	100 %	100 %	100 %	100 % ^②	100 % ^②
Inrush current	—	—	—	—	—	—	—	—
Rated input current	mA approx. 4	approx. 1.2 (at 5 V DC) approx. 3.3 (at 12 V DC)	approx. 1.2 (at 5 V DC) approx. 3.3 (at 12 V DC)	approx. 1.2 (at 5 V DC) approx. 3.3 (at 12 V DC)	approx. 4	approx. 4	approx. 4	approx. 4
ON	voltage V ≥ DC 28	≥ DC 3.5	≥ DC 3.5	≥ DC 3.5	≥ DC 19	≥ DC 19	≥ DC 19	≥ DC 19
	current mA ≥ DC 2.5	≥ DC 1	≥ DC 1	≥ DC 3	≥ DC 3	≥ DC 3	≥ DC 3	≥ DC 3
OFF	voltage V ≤ DC 10	≥ DC 1	≤ DC 1	≤ DC 1	≤ DC 11	≤ DC 11	≤ DC 11	≤ DC 9.5
	current mA ≤ DC 1.7	≥ DC 0.1	≤ DC 0.1	≤ DC 0.1	≤ DC 1.7	≤ DC 1.7	≤ DC 1.7	≤ DC 1.5
Load resistance	kΩ approx. 11.2	approx. 3.3	approx. 3.3	approx. 3.3	approx. 5.6	approx. 5.6	approx. 5.6	approx. 5.6
Response time	OFF → ON ms 1 – 70 ^①	1 – 70 ^①	1 – 70 ^①	1 – 70 ^①	1 – 70 ^①	1 – 70 ^①	1 – 70 ^①	0.1 – 1 ^①
	ON → OFF ms 1 – 70 ^①	1 – 70 ^①	1 – 70 ^①	1 – 70 ^①	1 – 70 ^①	1 – 70 ^①	1 – 70 ^①	0.1 – 1 ^①
Common terminal arrangement	16	16	32	32 x 2	16	32	32 x 2	32 x 2
Power indicator	All modules with 16 and 32 inputs possess a status LED per input. For modules with 64 inputs the indication is switchable.							
Connection terminal	18-point removable terminal block	18-point removable terminal block	40-pin connector	40-pin connector x 2	18-point removable terminal block	Compact connector 37-pin D-Sub	40-pin connector x 2	40-pin connector x 2
No. of occupied I/O points	16	16	32	64	16	32	64	64
Applicable wire size	mm ² 0.3	0.3 – 0.75	0.3	0.3	0.3 – 0.75	0.3	0.3	0.3
Internal power consumption (5 V DC)	mA 50 (all input points ON)	55 (all input points ON)	70 (all input points ON)	85 (all input points ON)	50 (all input points ON)	75 (all input points ON)	90 (all input points ON)	90 (all input points ON)
Weight	kg 0.13	0.14	0.12	0.13	0.16	0.16	0.18	0.18
Dimensions (W x H x D)	mm 27.4 x 98 x 90	27.4 x 98 x 90	27.4 x 98 x 90	27.4 x 98 x 90	27.4 x 98 x 90	27.4 x 98 x 90	27.4 x 98 x 90	27.4 x 98 x 90
Order information	Art. no. 204678	136397	136398	136399	127587	129594	150836	150837

Accessories 40-pin connector and ready to use connection cables and system terminals (refer to page 42–44); Spring clamp terminal block for exchange against the standard screw terminal block (refer to page 47)

^① CPU parameter setting (default setting: 10 ms) ^② at 45 °C ^③ Please refer to page 51 for diagrams showing the simultaneously switchable inputs.

Digital Output Modules

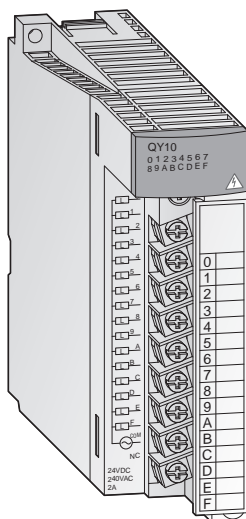

Adapted output technology

The MELSEC System Q output modules have different switching elements for adaptation to many control tasks.

Special features:

- Output modules with relay, transistor or triac switches
- Potential isolation between process and control by means of an optocoupler is a standard feature
- Modules with potential isolation between the channels
- Modules with 16 protection points have removable terminal blocks with screws
- Assembled cables are available for modules with D-sub plugs (Q32CBL: 3 m or 5 m; Q40CBL: 3 m or 5 m).
- Different system terminals for simplified cabling and to supplement the performance of the modules are available (refer to page 42).

Specifications	QY10	QY18A	QY22	QY40P	QY41P	QY42P	QY50
Outputs	16	8	16	16	32	64	16
Output type	Relay	Relay	Triac	Transistor (sink type)	Transistor (sink type)	Transistor (sink type)	Transistor (sink type)
Common terminal arrangement points	16	8	16	16	32	32	16
Insulation method	Relay	Relay	Photocoupler isolation between output terminals and PC power				
Rated output voltage	24 V DC / 240 V AC	24 V DC / 240 V AC	100 – 240 V AC	12 / 24 V DC (sink type)	12 / 24 V DC (sink type)	12 / 24 V DC (sink type)	12 / 24 V DC (sink type)
Operating voltage range	—	—	—	10.2 – 28.8 V DC	10.2 – 28.8 V DC	10.2 – 28.8 V DC	10.2 – 28.8 V DC
Min. switching load	5 V DC (1 mA)	5 V DC (1 mA)	24 V AC (100 mA) 100 V AC (25 mA) 240 V AC (25 mA)	—	—	—	—
Max. switching voltage	125 VDC / 264 VAC	125 VDC / 264 VAC	—	—	—	—	—
Max. output current	A 2	2	0.6	0.1	0.1	0.1	0.5
Output current per group TYP	A 8	8	4.8	1.6	2	2	4
Inrush current	—	—	—	0.7 for 10 ms	0.7 for 10 ms	0.7 for 10 ms	0.7 for 10 ms
Leakage current at OFF	mA	—	—	≤ 0.1 mA	≤ 0.1 mA	≤ 0.1 mA	≤ 0.1 mA
Response time	OFF → ON	ms ≤ 10	≤ 10	1	≤ 1	≤ 1	≤ 1
	ON → OFF	ms ≤ 12	≤ 12	1	≤ 1	≤ 1	≤ 1
Life	mechanical	Switching 20 million times		—	—	—	—
	electrical	Switching 100000 times or more		—	—	—	—
Max. switching frequency	Switching 3600 times/h		—	—	—	—	—
Noise suppression	—	—	RC-	Zener diode	—	—	Zener diode
Fuse	A	—	—	—	short-circuit proof	short-circuit proof	6.7
Power indicator	All modules possess a status LED per output.						
Fuse blown indicator	—	—	—	—	—	—	LED
Connection terminal	18-point removable terminal block				40-pin connector	40-pin connector x 2	18-point removable terminal block
No. of occupied I/O points	16	16	16	16	32	64	16
Applicable wire size	mm ² 0.3 – 0.75	0.3 – 0.75	0.3 – 0.75	0.3 – 0.75	0.3	0.3	0.3 – 0.75
Ext. power supply req.	voltage	—	—	—	12 – 24 V DC	12 – 24 V DC	12 – 24 V DC
	current	mA	—	—	10 (24 V DC)	20 (24 V DC)	20 (24 V DC)
Internal power consumption (5 V DC)	mA	430	430	250	65	105	150
Weight	kg	0.22	0.22	0.40	0.16	0.15	0.17
Dimensions (W x H x D)	mm	27.4 x 98 x 90	27.4 x 98 x 90	27.4 x 98 x 90	27.4 x 98 x 90	27.4 x 98 x 90	27.4 x 98 x 90
Order information	Art. no.	129605	136401	136402	132575	132576	132577
Accessories	40-pin connector and ready to use connection cables and system terminals (refer to page 42–44); Spring clamp terminal block for exchange against the standard screw terminal block (refer to page 47);						

Digital Output Modules

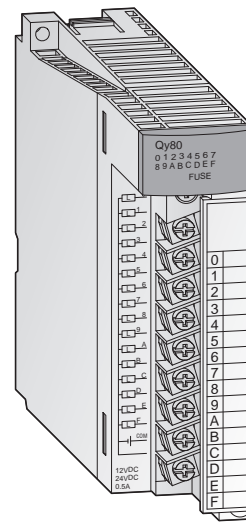
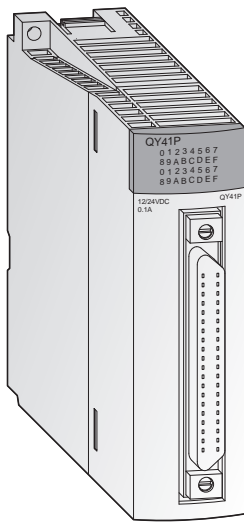

Specifications		QY68A	QY70	QY71	QY80	QY81P
Outputs		8	16	32	16	32
Output type		Transistor (sink/source type)	Transistor (sink type)	Transistor (sink type)	Transistor (source type)	Transistor (source type)
Common terminal arrangement	points	All independent	16	32	16	32
Insulation method		Photocoupler isolation between output terminals and PC power				
Rated output voltage		5 – 24 V DC	5 / 12 V DC (sink type)	5 / 12 V DC (sink type)	12 / 24 V DC (source type)	12 / 24 V DC (source type)
Operating voltage range		4.5 – 28.8 V DC	—	—	10.2 – 28.8 V DC	10.2 – 28.8 V DC
Min. switching load		—	—	—	—	—
Max. switching voltage		—	—	—	—	—
Max. output current	A	2	0.016	0.016	0.5	0.1
Output current per group TYP	A	—	0.256	0.512	4	2
Inrush current		8 A for 10 ms	40 mA for 10 ms	40 mA for 10 ms	4 A for ≤ 10 ms	0.7 A for ≤ 10 ms
Leakage current at OFF	mA	≤ 0.1	—	—	≤ 0.1	≤ 0.1
Response time	OFF → ON	ms	≤ 3	≤ 0.3	1	1
	ON → OFF	ms	≤ 10	≤ 0.3	1	1
Life	mechanical	—	—	—	—	—
	electrical	—	—	—	—	—
Max. switching frequency		—	—	—	—	—
Noise suppression		Zener diode	—	—	Zener diode	Zener diode
Fuse	A	—	1.6	1.6	4 A (2 pieces)	short-circuit proof
Power indicator		All modules possess a status LED per output.				
Fuse blown indicator		—	LED	LED	LED	LED
Connection terminal		18-point removable terminal block	18-point removable terminal block	40-pin connector	18-point removable terminal block	Compact connector 37-pin D-Sub
No. of occupied I/O points		16	16	32	16	32
Applicable wire size	mm ²	0.3 – 0.75	0.3 – 0.75	0.3	0.3 – 0.75	0.3
Ext. power supply req.	voltage	—	5 / 12 V DC	5 – 12 V DC	12 – 24 V DC	12 – 24 V DC
	current	mA	—	90 (12 V DC)	170 (12 V DC)	20 mA (24 V DC)
Internal power consumption (5 V DC)	mA	110	95	150	80	95
Weight	kg	0.14	0.14	0.10	0.17	0.15
Dimensions (W x H x D)	mm	27.4 x 98 x 90	27.4 x 98 x 90	27.4 x 98 x 90	27.4 x 98 x 90	27.4 x 98 x 90
Order information	Art. no.	136403	136404	136405	127588	129607
Accessories		40-pin connector and ready to use connection cables and system terminals (refer to page 42–44); Spring clamp terminal block for exchange against the standard screw terminal block (refer to page 47);				

■ Analog Input Modules

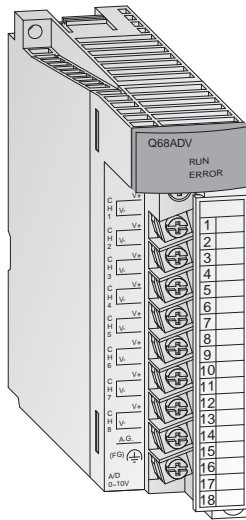

Detection of analog process signals

The analog input modules convert analog process signals, for example pressure, flow or fill level, linearly into digital values, which are further processed by the Q CPU.

Special features:

- Up to 8 channels per module (Q68AD□) and up to 256 channels per system (Q CPU)
- Resolution of 0.83 mV and 3.33 μA (Q64AD)
- Conversion time of 80 μs/channel (Q68AD□)
- Calculation of average value over the time or measurement cycles can be configured
- Potential isolation between process and control by means of an optocoupler is a standard feature.
- All modules are provided with a removable terminal block fastened with screws.

Specifications		Q64AD	Q68ADV	Q68ADI
Input points		4	8	8
Analog input		-10 V / +10 V (0 mA / +20 mA)	-10 V / +10 V	0 mA / +20 mA
Resolution		16 bits binary (incl. sign)	16 bits binary (incl. sign)	16 bits binary (incl. sign)
Load resistance	voltage	MΩ 1	1	1
	current	Ω 250	250	250
Max. input	voltage	V ±15	±15	±15
	current	mA ±30	±30	±30
I/O characteristics ^①	analog input	-10 – +10 V	0 – 20 mA	-10 – +10 V
	digital output	1/4000, 1/12000, 1/16000	1/4000, 1/8000, 1/12000	1/4000, 1/12000, 1/16000
Max. resolution	voltage input	2.5 mV 1.25 mV 0.83 mV	—	2.5 mV 5 mV 1.25 mV 1 mV
	current input	—	10 μA 5 μA 3.33 μA	—
Overall accuracy		±0.4 % (0 – 55 °C), ±0.1 % (20 – 30 °C)	±0.4 % (0 – 55 °C), ±0.1 % (20 – 30 °C)	±0.4 % (0 – 55 °C), ±0.1 % (20 – 30 °C)
Max. conversion time		80 μs/channel (+ 160 μs with temperature drift compensation)	80 μs/channel (+ 160 μs with temperature drift compensation)	80 μs/channel (+ 160 μs with temperature drift compensation)
Insulation method		Photocoupler isolation between output terminals and PC power for all modules.	Photocoupler isolation between output terminals and PC power for all modules.	Photocoupler isolation between output terminals and PC power for all modules.
I/O points		16	16	16
Connection terminal		All modules are fitted with a terminal block with 18 screw terminals.	All modules are fitted with a terminal block with 18 screw terminals.	All modules are fitted with a terminal block with 18 screw terminals.
External power consumption		Not necessary	Not necessary for any module	Not necessary for any module
Applicable wire size	mm ²	0.3 – 0.75	0.3 – 0.75	0.3 – 0.75
Internal power consumption (5 V DC)	mA	630	640	640
Weight	kg	0.14	0.19	0.19
Dimensions (W x H x D)	mm	27.4 x 98 x 90	27.4 x 98 x 90	27.4 x 98 x 90
Order information	Art. no.	129615	129616	129617

① ±0.4 % (0 – 55 °C), ±0.1 % (20 – 30 °C)

■ Analog Input Modules

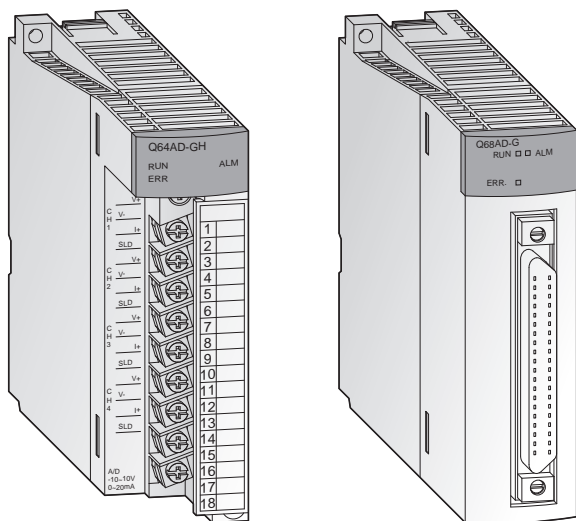

Channel isolated and high resolution

The analog input modules convert analog process signals into digital values with high accuracy. All channels are isolated between each other and against the external power supply with high dielectric withstand voltage for both.

Special features:

- Potential isolation between each channel and between process and control is a standard feature.
- High resolution: 32 bit signed binary
- High accuracy with a reference accuracy of $\pm 0.05\%$ and a temperature coefficient of $\pm 71.4 \text{ ppm}/^\circ\text{C}$
- Integrated short circuit protection by limiting the input current
- Signal conditioning function for the Q62AD-DGH
- Q66AD-DG signal converter
- A primary delay filter smoothes out the line of digital output values by a user-defined time constant
- All modules are provided with a removable terminal block fastened with screws.

Specifications	Q62AD-DGH	Q64AD-GH	Q66AD-DG	Q68AD-G	
Input points	2	4	6	8	
Analog input	+4 mA / +20 mA	-10 V / +10 V (0 mA / +20 mA)	0 mA / +4 mA / +20 mA	-10 V / +10 V (0 mA / +20 mA)	
Resolution	16 / 32 bits binary (incl. sign)	16 / 32 bits binary (incl. sign)	16 bits binary (incl. sign)	16 bits binary (incl. sign)	
Load resistance	voltage $\text{M}\Omega$	—	—	—	
	current Ω	250	250	250	
Max. input	voltage V	± 15	—	± 15	
	current mA	± 30	± 30	± 30	
I/O characteristics	analog input	4 – 20 mA	-10 – +10 V	0 – 20 mA	
	digital output	0 – 32000 (16 bits) 0 – 64000 (32 bits)	-32000 to +32000 (16 bits), -64000 to +64000 (32 bits), 0 – 32000 (16 bits), 0 – 64000 (32 bits)	-96 to +4095 (16 bits), -288 to +12287 (16 bits)	-12288 to +12287 (16 bits), -16384 to +16383 (16 bits), -32768 to +32767 (16 bits)
Max. resolution	voltage input	—	0 to 10 V: 156.3 μV (32 bits), 312.6 μV (16 bits), 0 to 5 V: 78.2 μV (32 bits), 156.4 μV (16 bits), 1 to 5 V: 62.5 μV (32 bits), 125.0 μV (16 bits), -10 to 10 V: 156.3 μV (32 bits), 312.6 μV (16 bits)	—	0 to 10 V: 0.625 mV (16 bits), 0 to 5 V: 0.416 mV (16 bits), 1 to 5 V: 0.333 mV (16 bits), -10 to 10 V: 0.625 mV (16 bits), user defined: 0.333mV (16 bits)
	current input	4 to 20 mA: 0.25 μA (32 bits), 0.50 μA (16 bits) user defined: 0.151 μA (32 bits), 0.303 μA (16 bits)	0 to 20 mA: 0.312 μA (32 bits), 0.625 μA (16 bits) 4 to 20 mA: 0.25 μA (32 bits), 0.50 μA (16 bits) user defined: 0.151 μA (32 bits), 0.303 μA (16 bits)	0 to 20 mA: 1.66 μA (16 bits) 4 to 20 mA: 1.33 μA (16 bits) user defined: 1.33 μA (16 bits)	0 to 20 mA: 1.66 μA (16 bits) 4 to 20 mA: 1.33 μA (16 bits) user defined: 1.33 μA (16 bits)
Overall accuracy	$\pm 0.05\%$	$\pm 0.05\%$	$\pm 0.1\%$	$\pm 0.1\%$	
Temperature coefficient	$\pm 71.4 \text{ ppm}/^\circ\text{C}$ (0.00714 %/ $^\circ\text{C}$)	$\pm 71.4 \text{ ppm}/^\circ\text{C}$ (0.00714 %/ $^\circ\text{C}$)	$\pm 71.4 \text{ ppm}/^\circ\text{C}$ (0.00714 %/ $^\circ\text{C}$)	$\pm 71.4 \text{ ppm}/^\circ\text{C}$ (0.00714 %/ $^\circ\text{C}$)	
Max. conversion time	10 ms/2 channels	10 ms/4 channels	10 ms/channel	10 ms/channel	
Insulation method	Photocoupler isolation between each channel	Photocoupler isolation between each channel	Transformer isolation between the input channels and between the channels and PLC power	Transformer isolation between the input channels and between the channels and PLC power	
I/O points	16	16	16	16	
Connection terminal	All modules are fitted with a terminal block with 18 screw terminals.	All modules are fitted with a terminal block with 18 screw terminals.	40-pin connector at the front	40-pin connector at the front	
External power consumption	24 V DC, 360 mA	Not necessary	24 V DC, 360 mA	Not necessary	
Applicable wire size	mm^2 0.3 – 0.75	0.3 – 0.75	0.3	0.3	
Internal power consumption (5 V DC)	220 mA	890	420	460	
Weight	kg 0.19	0.20	0.22	0.16	
Dimensions (W x H x D)	mm 27.4 x 98 x 90	27.4 x 98 x 90	27.4 x 102 x 130	27.4 x 102 x 90	
Order information	Art. no. 145036	143542	204676	204675	

■ Analog Output Modules

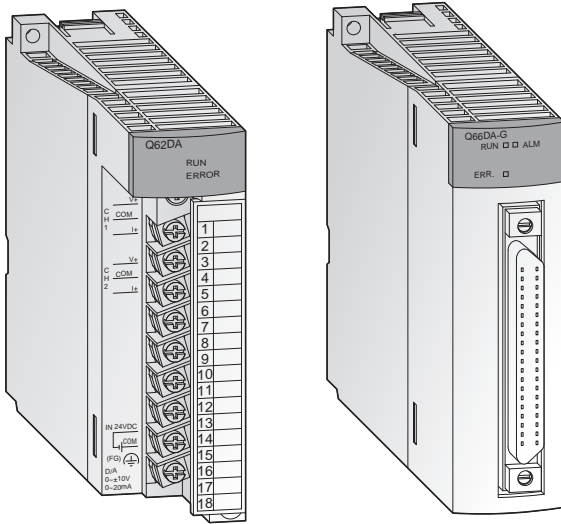

Output of analog control signals

The analog output modules convert digital values predetermined by the CPU into an analog current or voltage signal. For example, frequency inverters, valves or slide valves are controlled by means of these signals.

Special features:

- Up to 8 channels per module (Q68DA□) and up to 256 channels per system
- Resolution of 0.333 mV and 0.83 μA
- Conversion time of 80 μs / channel
- Potential isolation between process and control by means of an optocoupler is a standard feature. Additional potential isolation between the channels for the Q62DANQ, 62DAN-FGQ, 68DAVN and Q68DAIN.
- Disconnection detection function that monitors the output values by means of re-conversion and limit exceeding function (Q62DAN-FG only)
- The modules are provided with a removable terminal block fastened with screws.

3 SPECIAL FUNCTION MODULES

Specifications	Q62DAN	Q62DA-FG	Q64DAN	Q66DA-G	Q68DAVN	Q68DAIN			
Output points	2	2	4	6	8	8			
Digital input	-4096 – +4095 -12288 – +12287 -16384 – +16383	-4096 – +4095 -12288 – +12287 -16384 – +16383	-4096 – +4095 -12288 – +12287 -16384 – +16383	-4096 – +4095 -12288 – +12287 -16384 – +16383	-4096 – +4095 -12288 – +12287 -16384 – +16383	-4096 – +4095 -12288 – +12287 -16384 – +16383	-4096 – +4095 -12288 – +12287 -16384 – +16383		
Analog output	-10 V DC – +10 V DC (0 mA – +20 mA DC)	-10 V DC – +10 V DC (0 mA – +20 mA DC)	-10 V DC – +10 V DC (0 mA – +20 mA DC)	-12 V DC – +12 V DC (0 mA – +22 mA DC)	-10 V DC – +10 V DC	0 mA – +20 mA DC			
Load resistance	voltage output	1 kΩ – 1 MΩ	1 kΩ – 1 MΩ	1 kΩ – 1 MΩ	1 kΩ – 1 MΩ	—			
	current output	0 – 600 Ω	0 – 600 Ω	0 – 600 Ω	—	0 – 600 Ω			
Max. outputs	voltage	V ±12	±13	±12	±13	±12	—		
	current	mA 21	23	21	23	—	21		
Voltage output^①									
I/O characteristics	voltage output	0 – 5 V	0 – 5 V	1 – 5 V	1 – 5 V	-10 – +10 V	-10 – +10 V	user defined	user defined
	digital input	0 – 4000	0 – 12000	0 – 4000	0 – 12000	-4000 – 4000	-16000 – 16000	-4000 – 4000	-12000 – 12000
Max. resolution	1.25 mV	0.416 mV	1.0 mV	0.333 mV	2.5 mV	0.625 mV	0.75 mV	0.333 mV	
Current output^②									
I/O characteristics	current output	0 – 20 mA	0 – 20 mA	4 – 20 mA	4 – 20 mA	user defined	user defined	user defined	user defined
	digital input	0 – 4000	0 – 12000	0 – 4000	0 – 12000	-4000 – 4000	-16000 – 16000	-4000 – 4000	-12000 – 12000
Max. resolution	5 μA	4 μA	1.66 μA	1.33 μA	1.5 μA	0.75 μA	0.625 μA	0.333 μA	
Overall accuracy	±0.3 % conforms to voltage ±30 mV, current ±60 μA (at 0 – 55 °C); ±0.1 % conforms to voltage ±10 mV, current ±20 μA (at 20 – 30 °C)								
Max. conversion time	80 μs / channel	10 ms / 2 channels	80 μs / channel	6 ms / Kanal	80 μs / channel	80 μs / channel	80 μs / channel		
Insulation method	Photocoupler isolation between output terminals and PLC power	Each output is photocoupler isolated between each other and against the PLC power	Photocoupler isolation between output terminals and PLC power	Transformer isolation between the output channels and between the channels and PLC power.	Photocoupler isolation between output terminals and PLC power	Photocoupler isolation between output terminals and PLC power			
I/O points	16	16	16	16	16	16			
Connection terminal	Removable terminal block with 18 screw terminals	Removable terminal block with 18 screw terminals	Removable terminal block with 18 screw terminals	40-pin connector at the front	Removable terminal block with 18 screw terminals	Removable terminal block with 18 screw terminals			
Applicable wire size	mm ² 0.3 – 0.75	0.3 – 0.75	0.3 – 0.75	—	0.3 – 0.75	0.3 – 0.75			
Internal power consumption (5 V DC)	mA 330	370	340	620	390	380			
Weight	kg 0.19	0.20	0.19	0.22	0.18	0.18			
Dimensions (W x H x D)	mm 27.4 x 98 x 90	27.4 x 98 x 90	27.4 x 98 x 90	27.4 x 102 x 130	27.4 x 98 x 90	27.4 x 98 x 90			
Order information	Art. no. 200689	145037	200690	204677	200691	200692			

① Values are valid for all modules except for Q68DAIN; ② Values are valid for all modules except for Q68DAVN

■ Analog Modules for Temperature Measurement

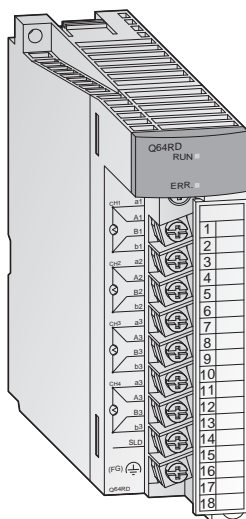

Temperature measurement by thermocouple

These modules are designed to convert external platinum temperature-measuring resistor input values into 16 or 32-bit signed binary temperature measurement values and scaling values.

The reference temperature is determined by means of a Pt100 resistance thermometer for the Q64RD module (Q64RD-G additionally with Ni100 resistors) and by means of a thermocouple for the Q64TD and Q64TDV-GH modules.

Special features:

- Temperature of 4 channels can be measured by one module
- Two kinds of platinum temperature measuring resistors compliant with the JIS, IEC and DIN standards are supported.
- The disconnection of a platinum temperature-measuring resistor or cable can be detected on each channel
- Selection of sampling processing/time averaging processing/count averaging processing
- Error compensation by offset/gain value setting
- Alarm output when limit value is exceeded
- Potential isolation between process and control by means of an optocoupler is a standard feature. Additional potential isolation between the channels for Q64TDV-GH and Q64RD-G.
- Removable terminal block fastened with screws.

Specifications	Q64RD	Q64RD-G	Q64TD	Q64TDV-GH
Input channels	4	4	4	4
Connectable thermocouple type	Pt100 (conforms to JIS C 1604-1989 and DIN IEC 751), JPt100 (conforms to JIS C 1604-1981)	Pt100 (conforms to JIS C 1604-1997 and DIN IEC 751-1983), JPt100 (conforms to JIS C 1604-1981), Ni100Ω (conf. to DIN 43760-1987)	K, E, J, T, B, R, S, N (conforms to JIS C1602-1995, IEC 584-1 and 584-2)	K, E, J, T, B, R, S, N (conforms to JIS C1602-1995, IEC 584-1 and 584-2)
Temperature measuring range	Pt100: -200 – 850 °C, JPt100: -180 – 600 °C	Pt100: -200 – 850 °C, JPt100: -180 – 600 °C, Ni100Ω: -60 – 180 °C	Depends on the thermocouple used	Depends on the thermocouple used
Temperature scaling value	16-bit, signed binary: -2.000 – +8.500 32-bit, signed binary: -200.000 – +850.000	16-bit, signed binary: -2.000 – +8.500 32-bit, signed binary: -200.000 – +850.000	16-bit, signed binary: -2.700 – +18.200 32-bit, signed binary: —	16-bit, signed binary: -25.000 – +25.000 32-bit, signed binary: —
Max. resolution	°C 0.025	0.025 °C	B, R, S, N: 0.3 °C; K, E, J, T: 0.1 °C	B: 0.7 °C; R, S: 0.8 °C; K, T: 0.3 °C; E, J: 0.1 °C; N: 0.4 °C; Voltage: 4 μV
Cold junction temp. compensation accuracy	—	—	±1.0 °C	±1.0 °C
Overall accuracy	±0.08 % (accuracy relative to full-scale value) at ambient temperature 25 ± 5 °C	±0.04 % (accuracy relative to full-scale value) at ambient temperature 25 ± 5 °C	Depends on the thermocouple used	Depends on the thermocouple used
Max. conversion time	40 ms / channel	40 ms per channel	20 ms / channel	20 ms / channel
Analog inputs	4 channels/module	4 channels/module	4 channels/module + Pt100 connection	4 channels/module + Pt100 connection
Temp. measurement output current	mA 1	1	—	—
Insulation method	Transformer insulation between power supply and temperature inputs	Photocoupler isolation between each channel and PLC power. Transformer isolation between measuring input and channel	Transformer insulation between thermocouple inputs as well as thermocouple and earth	Transformer isolation between each channel and between the channels and PLC power
Disconnection detection	For each channel independent	For each channel independent	For each channel independent	For each channel independent
I/O points	16	16	16	16
Connection terminal	All modules are fitted with a removable terminal block with 18 screw terminals.			
Applicable wire size	mm ² 0.3 – 0.75	0.3 – 0.75	0.3 – 0.75	0.3 – 0.75
Internal power consumption (5 V DC)	mA 600	620	500	500
Weight	kg 0.17	0.20	0.25	0.25
Dimensions (W x H x D)	mm 27.4 x 98 x 90	27.4 x 98 x 112	27.4 x 98 x 90	27.4 x 98 x 90
Order information	Art. no. 137592	154749	137591	143544

Temperature Control Modules

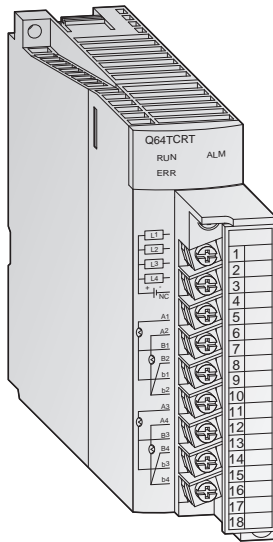

Temperature control modules with PID algorithm

These modules enable PID algorithm temperature control without placing any load on the PLC CPU for the temperature control tasks.

Special features:

- Four temperature input channels
- Auto-tuning function for the 4 PID control circuits
- Temperature control can continue even when the PLC program is stopped
- Transistor output with pulse train to drive the actuator in the control circuit
- The module is provided with a removable terminal block fastened with screws.

Specifications		Q64TCRT	Q64TCRTBW	Q64TCTT	Q64TCTTBW
Control output	type	Transistor	Transistor	Transistor	Transistor
Inputs		4 channels per module	4 channels per module / broken wire detection	4 channels per module	4 channels per module / broken wire detection
Supported thermocouples		Pt100 (-200 – +600 °C), JPt100 (-200 – +500 °C)		R, K, J, T, S, B, E, N, U, L, P L II, W5Re/W26Re	
Sampling cycle		0.5 s / 4 channels	0.5 s / 4 channels	0.5 s / 4 channels	0.5 s / 4 channels
Control output cycle	s	1 – 100	1 – 100	1 – 100	1 – 100
Input filter		1 – 100 s (0 s: input filter OFF)	1 – 100 s (0 s: input filter OFF)	1 – 100 s (0 s: input filter OFF)	1 – 100 s (0 s: input filter OFF)
Temperature control method		PID ON/OFF impulse or 2-position control		PID ON/OFF impulse or 2-position control	
PID constant range	PID constant setting	Setting with automatic tuning possible		Setting with automatic tuning possible	
	proportional band P	0.0 – 1000 % (0 %: 2-position control)		0.0 – 1000 % (0 %: 2-position control)	
	integral time I	1 – 3600 s	1 – 3600 s	1 – 3600 s	1 – 3600 s
	differential time D	1 – 3600 s (0 setting for PID control)	1 – 3600 s (0 setting for PID control)	1 – 3600 s (0 setting for PID control)	1 – 3600 s (0 setting for PID control)
Target value setting range		Within the temperature range of the Pt100 sensor used		Within the temperature range of the thermocouple used	
Dead band setting range		0.1 – 10.0 %	0.1 – 10.0 %	0.1 – 10.0 %	0.1 – 10.0 %
Transistor output	output signal (sink)	ON/OFF pulse	ON/OFF pulse	ON/OFF pulse	ON/OFF pulse
	rated load voltage	10 – 30 V DC	10 – 30 V DC	10.2 – 30 V DC	10.2 – 30 V DC
	max. load current	0.1 A/1 point, 0.4 A/common	0.1 A/1 point, 0.4 A/common	0.1 A/1 point, 0.4 A/common	0.1 A/1 point, 0.4 A/common
	max. rush current	400 mA for 10 ms	400 mA for 10 ms	400 mA for 10 ms	400 mA for 10 ms
	max. voltage drop when ON	0.1 V DC (TYP) 0.1 A 2.5 V DC (MAX) 0.1 A	0.1 V DC (TYP) 0.1 A 2.5 V DC (MAX) 0.1 A	0.1 V DC (TYP) 0.1 A 2.5 V DC (MAX) 0.1 A	0.1 V DC (TYP) 0.1 A 2.5 V DC (MAX) 0.1 A
	response time	OFF → ON: < 2 ms ON → OFF: < 2 ms	OFF → ON: < 2 ms ON → OFF: < 2 ms	OFF → ON: < 2 ms ON → OFF: < 2 ms	OFF → ON: < 2 ms ON → OFF: < 2 ms
Insulation method		Transformer	Transformer	Transformer	Transformer
I/O points		16 / 1 slot	32 / 2 slots	16 / 1 slot	32 / 2 slots
Connection terminals		All modules are fitted with a terminal block with 18 screw terminals.			
Applicable wire size	mm ²	0.3 – 0.75	0.3 – 0.75	0.3 – 0.75	0.3 – 0.75
Internal power consumption (5 V DC)	mA	550	60	550	640
Weight	kg	0.2	0.3	0.2	0.3
Dimensions (W x H x D)	mm	27.4 x 98 x 90	27.4 x 98 x 90	27.4 x 98 x 90	27.4 x 98 x 90
Order information	Art. no.	136386	136387	136388	136389

Loop Control Module

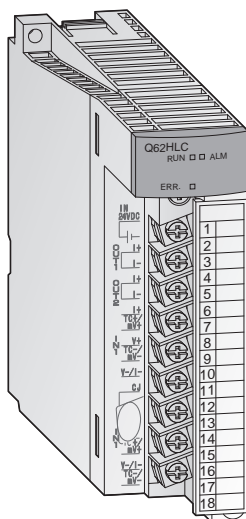

For fast response control

The Q62HLC loop control module uses a continuous proportional PID control format, which features a sampling period of 25 ms for high-accuracy, high-resolution thermocouple inputs, microvoltage inputs, voltage inputs, current inputs and current outputs. These features make the Q62HLC ideal for applications such as rapid temperature increase control, pressure control and flow rate control.

Special features:

- Staggering 25 ms sampling and control update time make the Q62HLC to one of the fastest control module in the market
- Supports sensor types, such as thermocouple, microvoltage, voltage and current input range
- Continuous proportional PID control by 4 to 20 mA current output results in highly stable and accurate control
- Control program profiles can be specified where set values and PID constants are automatically changed at specific times.
- Cascade control can be performed with channel 1 as the master and channel 2 as the slave.

Technische Daten		Q62HLC	
Number of input channels		2	
Analog input	thermocouple	°C	-200 – +2300 (0.1 °C resolution)
	micro voltage	mV	-100 – +100 (0.5 – 10 µV resolution)
	voltage	V	-10 – +10 (0.05 – 1 mV resolution)
	current	mA	0 – 20 (0.8 – 1 µA resolution)
Digital output		-2000 – +23000, -10000 – +10000, -10000 – +10000, 0 – 20000	
Supported thermocouples		K, J, T, S, R, N, E, B, PL II, W5re/W26Re	
Max. conversion speed		25 ms / 2 channels	
Normal mode rejection ratio		60 dB or more (50/60 Hz)	
Common mode rejection ratio		120 dB or more (50/60 Hz)	
Input filter (primary delay digital filter)		0.0 to 100.0 s	
Sensor compensation value setting		-50.00 to 50.00 %	
Control method		Continuous proportional control	
PID constant range	PID constant setting		Setting possible by auto-tuning
	proportional band (P)		Thermocouple: 0.1 to full scale °C; micro voltage, voltage, current: 0.1 – 1000.0 %
	integral time (I)	s	0.0 to 3276.7
	differential time (D)	s	0.0 to 3276.7
Set value setting range		Thermocouple: input range of thermocouple being used	
Dead band setting range		0.1 to 10.0 %	
I/O points		16	
Isolation		Transformer isolation between the input channels and between the inputs and ground	
Connection terminals		Terminal block with 18 screw terminals.	
Applicable wire size	mm ²	0.3 – 0.75	
External power supply		24 V DC, 70 m A	
Internal power consumption (5 V DC)	mA	270	
Weight	kg	0.25	
Dimensions (W x H x D)	mm	27.4 x 98 x 112	
Order information	Art. no.	200693	

■ High-Speed Counter Modules

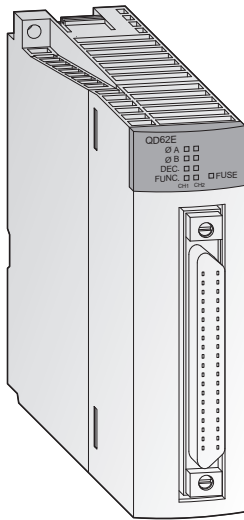

High-speed counter with automatic detection of rotation direction

These counter modules detect signals with a frequency which cannot be detected by normal input modules. For example, simple positioning tasks or frequency measurements can be realized.

Special features:

- Input for incremental shaft encoder with automatic forward and reverse detection
- Preset count via external signals or the PLC program with the aid of the PRESET function
- Ring counter function for counting up to a predefined value with automatic resetting to the starting value
- Functions such as speed measurement, definition of switching points or periodic counting are available.
- The modules QD62□ are provided with a 40-pin connector interface (for suitable connectors, please refer to the chapter "Accessories").
- The module QD60P8-G is provided with a removable terminal block fastened with screws.

Specifications	QD62E	QD62	QD62D	QD60P8-G
Counter inputs	2	2	2	8
Signal levels	5 / 12 / 24 V DC (2 – 5 mA)	5 / 12 / 24 V DC (2 – 5 mA)	5 / 12 / 24 V DC (2 – 5 mA) (RS422A)	5 / 12 / 24 V DC
Max. counting frequency	kHz 200	200	500 (differential)	30
Max. counting speed	1-phase-input kHz 200 or 100	200 or 100	500 or 200	30
	2-phase-input kHz 200 or 100	200 or 100	500 or 200	—
Counting range	32 bits + sign (binary), -2147483648 bis +2147483647	32 bits + sign (binary), -2147483648 bis +2147483647	32 bits + sign (binary), -2147483648 bis +2147483647	16 bits binary: 0 – 32767 32 bits binary: 0 – 99999999 32 bits binary: 0 – 2147483647
Counter type	All modules are equipped with UP/DOWN preset counter and ring counter function.			Moving average function, alarm output and pre-scale function
Comparison range	32 bits + sign (binary)	32 bits + sign (binary)	32 bits + sign (binary)	32 bits + sign (binary)
External digital input points	Preset, function start			
Rated voltage/current for external input	5 / 12 / 24 V DC (2 – 5 mA)	5 / 12 / 24 V DC (2 – 5 mA)	5 / 12 / 24 V DC (2 – 5 mA) (RS422A)	5 / 12 / 24 V DC
External digital output points (coincidence signal)	2 points/channel 12 / 24 V DC 0.1 A/point, 0.4 A/common (source)	2 points/channel 12 / 24 V DC 0.5 A/point, 2.0 A/common (sink)	2 points/channel 12 / 24 V DC 0.5 A/point, 2.0 A/common (sink)	—
I/O points	16	16	16	32
Connection terminal	40-pin connector interface on the front	40-pin connector interface on the front	40-pin connector interface on the front	Terminal block with 18 screw terminals
Applicable wire size	mm ² 0.3	0.3	0.3	0.3 – 0.75
Internal power consumption (5 V DC)	mA 330	300	380	580
Weight	kg 0.12	0.11	0.12	0.17
Dimensions (W x H x D)	mm 27.4 x 98 x 90	27.4 x 98 x 90	27.4 x 98 x 90	27.4 x 98 x 90
Order information	Art. no. 128949	132579	132580	145038
Accessories	40-pin connector and ready to use connection cables and system terminals (refer to page 40–42)			

Positioning Modules

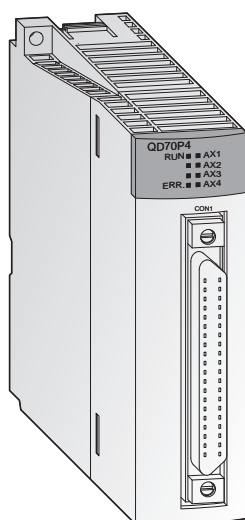

Multi-axis positioning

The modules are especially designed for systems including multiple axes that do not require any extensive control. The QD70P4 controls up to 4 axes and the QD70P8 up to 8 axes. Since any number of positioning modules can be used the number of axes to be controlled as well is unlimited.

Special features:

- Control of 4 or 8 axes by one module and more than 8 axes by using multiple modules
- Quick start of up to 8 axes simultaneously (0.1 ms per axis after start command from the CPU)
- Various positioning control systems are selectable.
- Easy parametrizing and positional data setup via optionally available positioning software GX Configurator-PT

Specifications	QD70P4	QD70P8
Number of control axes	4	8
Interpolation	—	
Points per axis	10 (by PLC program or with the positioning software GX Configurator PT)	
Output signal	Pulse chain	
Output frequency	kHz 1 – 200 000	
Positioning method	PTP positioning; speed/locus positioning; path control	
Positioning	units	Absolute data: -2 147 483 648 – 2 147 483 647 pulse Incremental method: -2 147 483 648 – 2 147 483 647 pulse Speed/position switching control: 0 – 2 147 483 647 pulse
	speed	0 – 200 000 pulse/s
	acceleration/deceleration processing	Automatic, acceleration and deceleration step by step
	acceleration and deceleration time	0 – 32767 ms
Pulse output type	Open collector output	
Max. servo motor cable length	m 2	2
I/O points	32	32
Applicable wire size	0.3 mm ² (with connector A6CON1); AWG24 (with connector A6CON2)	
Internal power consumption (5 V DC)	mA 550	740
External power consumption (24 V DC)	mA 65	120
Weight	kg 0.15	0.17
Dimensions (W x H x D)	mm 27.4 x 98 x 90	27.4 x 98 x 90
Order information	Art. no. 138328	138329
Accessories	40-pin connector and ready to use connection cables and system terminals (refer to page 40–42)	

■ Positioning Modules

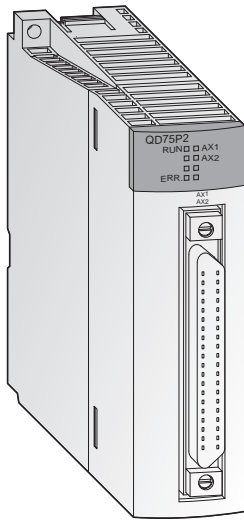

Positioning with an open control loop

The modules generate the travel command via a pulse chain. The speed is proportional to the pulse frequency and the distance travelled is proportional to the pulse length.

Special features:

- Control of up to three axes with linear interpolation (QD75P4) or circular interpolation (QD75P2, QD75P4)
- Storage of up to 600 positional data in the flash ROM (no back-up battery necessary)
- Units of travel can be defined in pulses, mm, inches or degrees.
- Configuration and presetting of all 600 positional data is performed via the PLC program or with the aid of the programming software GX Configurator QP. This software runs under Windows 95/98 and Windows 2000/NT.

Specifications	QD75P1	QD75P2	QD75P4
Number of control axes	1	2	4
Interpolation	—	2 axis linear and circular interpolation	2, 3, or 4 axis linear and 2 axis circular interpolation
Points per axis	600 pieces of data with PLC program, 100 pieces of data with GX Configurator QP		
Output type	Open collector	Open collector	Open collector
Output signal	Pulse chain	Pulse chain	Pulse chain
Output frequency	1 – 200 kHz	1–200	1–200
Positioning	method	PTP control: absolute data and/or incremental; speed/position switching control: incremental; locus/speed control: incremental; path control: absolute data and/or incremental	
	units	Absolute data: -2 147 483 648 – 2 147 483 647 pulse -21 474 836 48 – 214 748 364.7 μm -21 474.83648 – 21 474.83647 inch 0 – 359.99999 degree Incremental method: -2 147 483 648 – 2 147 483 647 pulse -214 748 364.8 – 214 748 364.7 μm -21 474.83648 – 21 474.83647 inch -21 474.83648 – 21 474.83647 degree	
		Speed/position switching control: 0 – 2 147 483 647 pulse 0 – 21 474 8364.7 μm 0 – 21 474.83647 inch 0 – 21 474.83647 degree	
	speed	1 – 1 000 000 pulse/s 0.01 – 20 000 000.00 mm/min 0.001 – 200 000.000 degree/min 0.001 – 200 000.000 inch/min	
	acceleration/deceleration processing	Automatic trapezoidal or S-pattern acceleration and deceleration or automatic S-pattern acceleration and deceleration	
	acceleration and deceleration time	1 – 8388608 ms (4 patterns each can be set)	
	rapid stop deceleration time	1 – 8388608 ms	
Max. length for servo motor cable	m	2	2
I/O points		32	32
Internal power consumption (5 V DC)	mA	400	580
Weight	kg	0.15	0.16
Dimensions (W x H x D)	mm	27.4 x 98 x 90	27.4 x 98 x 90
Order information	Art. no.	132581	132582
Accessories		40-pin connector and ready to use connection cables and system terminals (refer to page 40–42); Programming software: GX Configurator QP, art. no.: 132219	

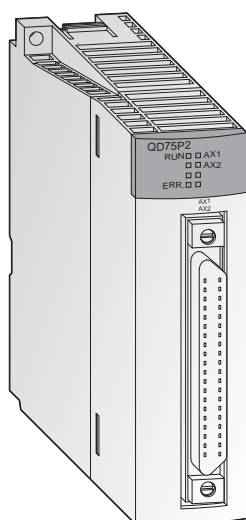
Positioning Modules

Long distance positioning

The modules QD75D1, QD75D2, and QD75D4 are suitable for bridging long distances between module and drive system. The modules provide differential outputs that allow large motor cable lengths.

QD75D1, QD75D2, and QD75D4 are designed for the operation across the motion network SSCNET.

Special features:

- Control of up to four axes with linear interpolation (QD75D4/QD75M4) or two axes circular interpolation (QD75D2/QD75M2, QD75D4/QD75M4)
- Storage of up to 600 positional data in the flash ROM (no back-up battery necessary)
- Units of travel can be defined in pulses, mm, inches or degrees.
- Configuration and presetting of all 600 positional data is performed via the PLC program or with the aid of the programming software GX Configurator QP. This software runs under Windows 95/98 and Windows 2000/NT.

Specifications	QD75D1	QD75M1	QD75D2	QD75M2	QD75D4	QD75M4
Number of control axes	1	1	2	2	4	4
Interpolation	—	—	2 axis linear and circular interpolation		2, 3, or 4 axis linear and 2 axis circular interpolation	
Points per axis	600 pieces of data with PLC program, 100 pieces of data with GX Configurator QP					
Output type	Differential driver	SSCNET	Differential driver	SSCNET	Differential driver	SSCNET
Output signal	Pulse chain	BUS	Pulse chain	BUS	Pulse chain	BUS
Output frequency	kHz	1–1000	1–1000	1–1000	1–1000	1–1000
Positioning	method	PTP control: absolute data and/or incremental; speed/position switching control: incremental; locus/speed control: incremental; path control: absolute data and/or incremental				
	units	Absolute data:	-2 147 483 648	-2 147 483 647	pulse	
			-21 474 8364.8	-214 748 364.7	µm	
			-21 474.83648	-21 474.83647	inch	
		0	359.99999	degree		
	Incremental method:	-2 147 483 648	-2 147 483 647	pulse		
		-214 748 364.8	-214 748 364.7	µm		
		-21 474.83648	-21 474.83647	inch		
		-21 474.83648	-21 474.83647	degree		
	Speed/position switching control:	0 – 2 147 483 647		pulse		
		0 – 21 474 8364.7		µm		
		0 – 21 474.83647		inch		
		0 – 21 474.83647		degree		
	speed	1 – 1 000 000		pulse/s		
		0.01 – 20 000 000.00		mm/min		
		0.001 – 200 000.000		degree/min		
		0.001 – 200 000.000		inch/min		
	acceleration/deceleration processing	Automatic trapezoidal or S-pattern acceleration and deceleration or automatic S-pattern acceleration and deceleration				
	acceleration and deceleration time	1 – 8388608 ms (4 patterns, each can be set)				
	rapid stop deceleration time	1 – 8388608 ms				
Max. length for servo motor cable	m	10	30	10	30	10
I/O points		32	32	32	32	32
Internal power consumption (5 V DC)	mA	520	520	560	560	820
Weight	kg	0.15	0.15	0.15	0.15	0.16
Dimensions (W x H x D)	mm	27.4 x 98 x 90	27.4 x 98 x 90	27.4 x 98 x 90	27.4 x 98 x 90	27.4 x 98 x 90
Order information	Art. no.	129675	142153	129676	142154	129677
Accessories		40-pin connector and ready to use connection cables and system terminals (refer to page 40–42); Programming software: GX Configurator QP, art. no.: 132219				

Interface Modules

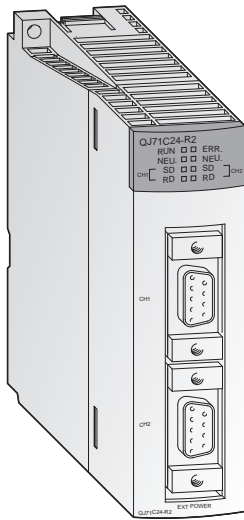

Data exchange with peripheral devices

This module enables communication with peripheral devices via a standard RS232 interface. The peripherals are connected point-to-point on a 1:1 basis.

Special features:

- The QJ71C24N provides one RS232 and one RS422/485 interface. The QJ71C24-R2 provides two RS232 interfaces and the QJ71C24N-R4 two RS422/485 interfaces.
- Enables PCs connected to the system to access the full data set of the MELSEC System Q CPU using graphic process supervision or monitoring software
- Integrated flash ROM memory for logging quality, productivity or alarm data that can be printed out when required
- Module and communications status shown by LEDs
- Communications test and monitor function are possible with the software GX-Configurator UT

Specifications		QJ71C24N	QJ71C24N-R2	QJ71C24N-R4	QJ71MB91	
Interface	channel 1	RS232 (9-pin Sub-D)	RS232 (9-pin Sub-D)	RS422 / RS485 (screw terminals)	RS232 (9-pin Sub-D)	
	channel 2	RS422 / RS485 (screw terminals)	RS232 (9-pin Sub-D)	RS422 / RS485 (screw terminals)	RS422 / RS485 (screw terminals)	
Communications mode		Full duplex / half duplex	Full duplex / half duplex	Full duplex / half duplex	Full duplex / half duplex	
Synchronisation		Asynchronous communications	Asynchronous communications	Asynchronous communications	Master/Slave	
Data transfer	rate	Bit/s	50 – 230400 (channel 1 only) 115200 (channel 1+2 simultaneously)	50 – 230400 (nur Kanal 1) 115200 (channel 1+2 simultaneously)	50 – 230400 (channel 1 only) 115200 (channel 1+2 simultaneously)	300 – 115200
	distance RS232	m	15	15	—	15
	distance RS422/485	m	1200 (if both channels are used)	—	1200 (if both channels are used)	1200
Max. no of stations in a multidrop network		no restrictions / 64	—	no restrictions / 64	Master (32 slaves) Slave (242)	
Data format		1 start bit, 7 or 8 data bits, 1 or 0 parity bits, 1 or 2 stop bits	1 start bit, 7 or 8 data bits, 1 or 0 parity bits, 1 or 2 stop bits	1 start bit, 7 or 8 data bits, 1 or 0 parity bits, 1 or 2 stop bits	Modbus RTU	
Error correction		Parity check, checksum	Parity check, checksum	Parity check, checksum	—	
DTR/DSR control		YES / NO selectable	YES / NO selectable	—	—	
X ON / X OFF (DC1 / DC3)		YES / NO selectable	YES / NO selectable	YES / NO selectable	—	
I/O points		32	32	32	32	
Internal power consumption (5 V DC)		mA	310	260	390	310
Weight		kg	0.2	0.2	0.2	0.2
Dimensions (W x H x D)		mm	27.4 x 98 x 90	27.4 x 98 x 90	27.4 x 98 x 90	27.4 x 98 x 90
Order information		Art. no.	149500	149501	149502	167757

High-Speed Communication Modules

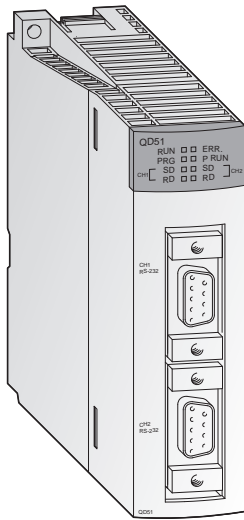

Programmable interface module

This module works through its own program independently of the PLC CPU. Thus, peripherals can be operated or mathematical operations performed without imposing an additional load on the PLC CPU. Programming is in AD51H-BASIC.

Special features:

- Two RS232C interfaces and one RS422/485 interface
- Two BASIC programs can be operated in parallel (multitasking).
- The tasks can be stored in the module as interpreter programs or in compiled form.
- The integrated Flash ROM is used for storage.
- Online and offline program creation is possible.
- The module and communication status is indicated by means of LEDs.
- Support for plain ASCII data exchange with connected devices such as barcode readers, scales and identification systems

Specifications			QD51-R24	QD51
Interfaces	type		1 x RS422/485, 1 x RS232	2 x RS232
Microprocessor	type		V53A (20 MHz)	V53A (20 MHz)
Number of parallel tasks			Max. 2	Max. 2
Start conditions for tasks			Started by power on, started by the start command from another task, start by an interruption from the PC CPU.	
Data transfer	rate	bit/s	≤ 38 400	≤ 38 400
	distance	m	500 (RS422/485), 15 (RS232C)	15 (RS232C)
Program language			AD51H-BASIC	AD51H-BASIC
Internal memory	program memory	kbyte	64 x 1 task or 32 x 2 tasks	64 x 1 task or 32 x 2 tasks
	common memory for tasks	kbyte	8	8
	data buffer to PLC	kbyte	6	6
	extension relays		1024	1024
	extension data registers		1024 (2 kbyte)	1024 (2 kbyte)
Memory backup capability			Provided for common memory, extension relay and extension register.	Provided for common memory, extension relay and extension register.
Memory for programs			Flash memory: 64 kbyte	Flash memory: 64 kbyte
I/O points			32 (1 slot)	32 (1 slot)
Internal power consumption (5 V DC)	mA		310	260
Weight	kg		0.2	0.2
Dimensions (W x H x D)	mm		27.4 x 98 x 90	27.4 x 98 x 90
Order information	Art. no.		136385	136384
Accessories			For both modules: programming software for PC/AT (MS-DOS): SW11X-AD51HPE, art. no.: 33102	

■ Web Server Module



Access to the System Q via the Internet

The web server module QJ71WS96 enables remote monitoring and maintenance of a System Q PLC system via the Internet.

Special features:

- Very easy setting functions integrated
- User needs only a Web browser for setting and monitoring.
- RS232 interface for modem connection
- Various connections for data exchange are possible: ADSL, modem, LAN, etc.
- Sending and receiving data via mail or FTP
- Integration of a self-designed web site and Java applets is possible
- Standard connection via ETHERNET to exchange data between other PLCs or PCs
- Events and CPU data protocol, storage functions

Specifications		QJ71WS96	
Module type		Web server, FTP server/client	
Transmission method		ETHERNET: CSMA/CD	
Interface	type	10BASE-T/100BASE-TX (mode is recognized automatically)	
Communications speed	Mbps	10BASE-T: 10 Mbps / 100BASE-TX: 100 Mbps	
Max. segment length	m	100 (between hub and node)	
RS-232 communications data	interface	RS232, 9-pin D-SUB	
	transfer type	Duplex	
	synchronisations method	Start/stop synchronisation	
	transfer speed	MBit/s	9.6 / 19.2 / 38.4 / 57.6 / 115.2
	transmission distance	m	Max. 15
	data format		1 start bit, 8 data bits, 1 stop bit
	transfer control		Floating control is possible (RS/CS)
Memory capacity	MB	5 (Standard-ROM); expandable with Compact Flash™ Card up to 512	
I/O points		32	
Internal power consumption (5 V DC)	mA	650	
Weight	kg	0.17	
Dimensions (W x H x D)	mm	27.5 x 98 x 90	
Order information	Art. no.	147115	

MES Interface Module

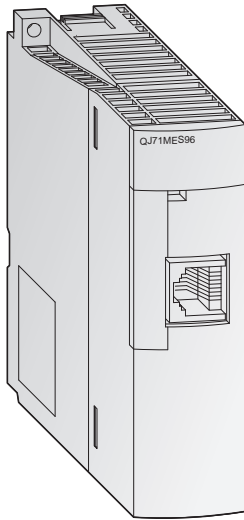

Direct connection from the shop floor to the MES databases

The new Qseries MES module allows users to interface their production control systems directly to an MES database. (MES: Manufacturing Execution System).

Special features:

- It removes the need for an interfacing PC layer - reducing hardware costs and installation time.
- It removes the need for specialist interfacing software run on the PC layer; saving on expensive software and services while reducing installation costs.
- It simplifies the MES architecture reducing the total commissioning time.
- It can improve reliability and accessibility as the module is based on industrial PLC design standards.
- The simplified system provides greater direct data visibility increasing the opportunity to achieve higher productivity.

Technische Daten		QJ71MES96
Module type		MES interface module
Transmission method		ETHERNET
Interface	type	10BASE-T/100BASE-TX
Data base interface function	common	Interacts with databases via user-defined jobs
	tag function	Collects device data of the PLC CPUs on the network in units of tags
	trigger monitoring function	Monitors the status of conditions (time, tag, values etc.) that initiate jobs
	trigger buffering function	The MES interface module buffers the data and trigger time to internal memory
	SQL text transmission	Automatically generates the correct SQL message according to requirements of each supported database type.
	arithmetic processing	Formulas can be applied to data before sending from the MES interface module.
	program execution	Executes programs in the application server computer at the beginning and end of a job.
Software functions	no. of connected databases	32 items/project max.
	supported databases	Oracle® 8i, Oracle® 9i, Oracle® 10g, Microsoft® SQL Server 2000, Microsoft® SQL Server 2000 Desktop Engine (MSDE2000), Microsoft® Access 2000, Microsoft® Access 2003
	no. of data settings	64 items/project max. (256 components/tag, 4096 components/project)
Memory capacity		1 Compact Flash™ card can be installed
I/O points		32
Internal power consumption (5 V DC)	mA	650
Weight	kg	0.16
Dimensions (W x H x D)	mm	27.5 x 98 x 90
Order information	Art. no.	200698

Interrupt Module

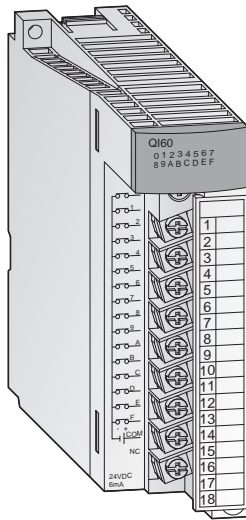

Branching to subroutines

The interrupt module QI60 is suitable for applications demanding quick responses.

Special features:

- Every input in this module is assigned to a pointer which serves as a branch mark for a subroutine.
- If an interrupt/alarm signal is applied at an input, the PLC program is interrupted after it has worked through the current statement and a subroutine assigned to the input is first processed.
- Galvanic isolation between process and controller by means of a photocoupler is a standard feature
- Only one QI60 can be installed per PLC system

Specifications		QI60	
Input points		16	
Rated input voltage	V DC	24 (sink type)	
Operating voltage range	V DC	24	
Max. input points simultaneous ON		100 %	
Input	resistance	kΩ	ca. 3.9
	current	mA	ca. DC 4 / 8
ON	voltage	V	≥ DC 19
	current	mA	≥ DC 4
OFF	voltage	V	≤ DC 11
	current	mA	≤ DC 1.7
Response time	OFF → ON	ms	≤ 0.2
	ON → OFF	ms	≤ 0.3
Status display of inputs		LED	
Insulation method		All modules are fitted with photocoupler isolation between input terminals and internal circuit.	
No. of occupied I/O points		16	
Connection terminal		The module is fitted with a terminal block with 18 screw terminals.	
Applicable wire size	mm ²	0.3 – 0.75	
Internal power consumption (5 V DC)	mA	60 (all points ON)	
Weight	kg	0.20	
Dimensions (W x H x D)	mm	27.4 x 98 x 90	
Order information	Art. no.	136395	

Dummy Module

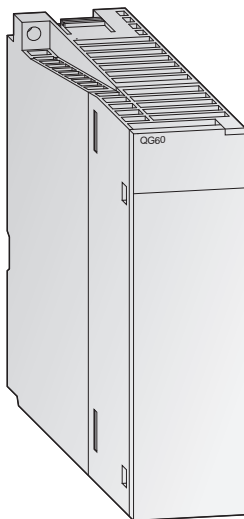

Place keeper and mechanical protection

The dummy module QG60 protects unused slots on the base unit from dust and reserve I/O addresses.

Special features:

- Tough protection of unused slot
- Unified front view

Specifications	QG60	
I/O points	0 – 1024 (selectable)	
Application	Used to protect any vacant slot from dust.	
Current consumption	mA	—
Weight	kg	0.07
Dimensions (W x H x D)	mm	27.4 x 98 x 90
Order information	Art. no.	129853

System Terminals

Transfer modules for simplified system cabling

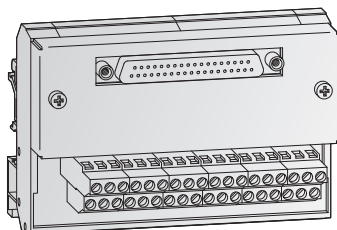

The system terminals are transfer modules for simplified cabling and to supplement the performance of the modules. In particular, these terminals permit a far higher output current through the addition of a transistor, relay or triac. Furthermore there are also terminals with built-in serial diodes for parallel switching available.

With the aid of prefabricated, screened cables that can also be supplied (see below), this connection concept provides independence from the output module connector technology and various special function modules.

For easy cabling the system terminals ST16-3 and ST32-3 have connection rows for voltage terminals (24 V / 0 V).

Specification	ST32	ST32-DI0D	ST32-3	ST40	ST16-3	ST16-SOCKET	
Operation range	Input/output modules	Output modules	Input/output modules	Special function modules	Input/output modules	Output modules	
Channels	32	32	32	40	16	16	
Design	Plain	Serial diode integrated	3 terminal rows with voltage terminals	Plain	3 terminal rows with voltage terminals	Sockets for relay, transistor or triac	
Application	All I/O modules with type 37 D-Sub connector	All output modules with type 37 D-Sub connector	All I/O modules with type 37 D-Sub connector	QD62E, QD62D, special function modules with 40-pin connector	All I/O modules with screw terminals	All output modules with type 37 D-Sub connector	
Dimensions (W x H x D)	mm	112.5 x 77 x 62	112.5 x 77 x 62	180 x 77 x 75	112.5 x 77 x 60	112.5 x 77 x 75	180 x 77 x 56
Order information	Art. no.	146888	146890	146891	146893	146894	146895
Accessories	Plug relay 6 A (16 pcs.) ST16-RELAY-6A for ST16-SOCKET; art. no.: 146897 Plug transistor 2 A (16 pcs.) ST16-TRANSISTOR-2A for ST16-SOCKET; art. no.: 146899 Plug triacs 1 A (16 pcs.) ST16-TRIAC-1A for ST16-SOCKET; art. no.: 146900 Jumper cable ST-JUMPER to bridge 16 terminal screws; art. no.: 146915						

Connection Cables

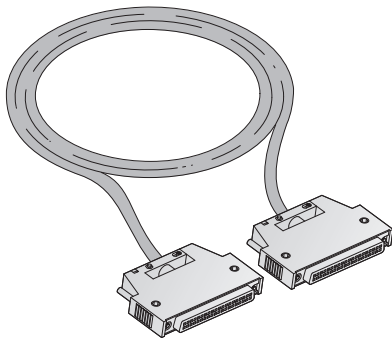

Connection cables for system terminals

The connection cables are for the connection of the system terminals to the input/output or special function modules of the MELSEC range. Thanks to the different lengths that are available, the correct cable can be selected for every application.

The connection cables Q16ST-CAB□□M are additionally equipped with an exchange block for changing to spring clamp terminals instead of the screw terminal block.

Specifications	Q16-ST-CAB-06M	Q16-ST-CAB-15M	Q16-ST-CAB-30M	Q32-ST-CAB03M	Q32-ST-CAB06M	Q32-ST-CAB15M	Q32-ST-CAB30M	Q40-ST40-CAB-06M	Q40-ST40-CAB-15M	Q40-ST40-CAB-30M	QD62E-CAB-06M	QD62E-CAB-15M	QD62E-CAB-30M	
Operation range (system terminal)	ST16	ST16	ST16	ST16/ST32	ST16/ST32	ST16/ST32	ST16/ST32	ST40	ST40	ST40	ST40	ST40	ST40	
Application	All I/O modules with screw terminal connection*			All I/O modules with type 37 D-Sub connector				All modules with 40-pin connector			For QD62E			
Length	m	0.6	1.5	3.0	0.3	0.6	1.5	3.0	0.6	1.5	3.0	0.6	1.5	3.0
Order information	Art. no.	146902	146903	146904	146905	146906	146907	146908	146909	146910	146911	146912	146913	146914

*for exchange of the standard terminal block against a spring clamp terminal block

Connection Cables

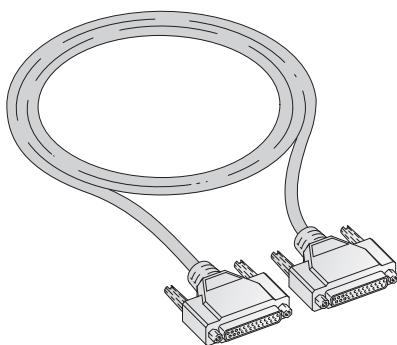

Connection cable for extension units

These connection cables are used for connecting base units to the extension units. They have been cut to the correct length for each application.

When the extension cables are used multiple, the overall distance of the cables should be within 13.2 m.

Specifications	QC05B	QC06B	QC12B	QC30B	QC50B	QC100B	
For extension base units	Q52B, Q55B	Q63B, Q65B, Q68B, Q612B	Q63B, Q65B, Q68B, Q612B	Q63B, Q65B, Q68B, Q612B	Q63B, Q65B, Q68B, Q612B	Q63B, Q65B, Q68B, Q612B	
Length	m	0.45	0.6	1.2	3.0	5.0	10.0
Order information	Art. no.	140380	129591	129642	129643	129644	129645

Tracking Cable

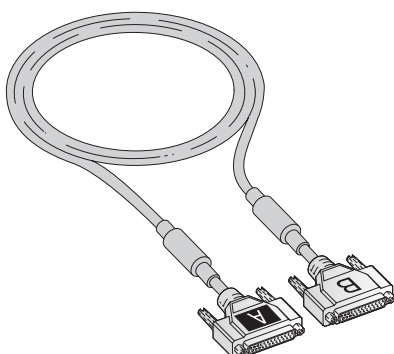

Connection cable for redundant CPUs

The tracking cable connects the two CPUs in a redundant system. Use only the QC10TR or QC30TR cables!

The connectors of the tracking cables are labelled A and B for System A and System B. When both systems are started at the

same time System A will be the active controller and System B will be the standby system.

The length of the extension cables cannot exceed 13.2 metre

Specifications	QC10TR	QC30TR	
Purpose	Connection of the two CPU modules in a redundant system (QnPRHCPU)		
Length	m	1.0 m	3.0 m
Order information	Art. no.	157068	157069

Programming Cable

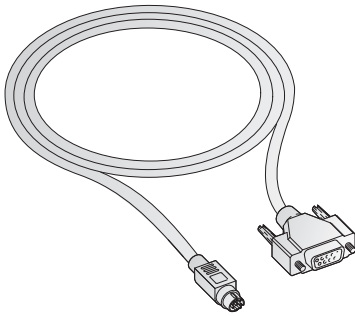

Programming cable for USB and RS232 interface

The programming cables QC30R2 and QC30-USB are used for programming a MELSEC system Q CPU via the RS232 or USB interface.

The programming cable provides a 9-pin D-sub connector for the PC side and a

6-pin Mini-DIN connector for the PLC interface.

The USB cable is especially suited for a fast connection between PC and CPU.

Specifications	QC30R2	QC30-USB
Connection cable for	Connection between a PCs and a MELSEC system Q PLC via RS232 interface	Connection between a PCs and a MELSEC system Q PLC via USB interface
Length	m 3.0	3.0
Order information	Art. no. 128424	136577
Accessories	Connector disconnection prevention holder Q6HLD-R2	

Connector Disconnection Prevention Holder

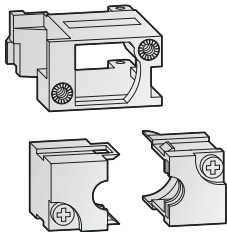

Disconnection prevention for RS232 cable

The connector disconnection prevention holder Q6HLD-R2 securely locks the RS232 connector of the programming cable to the CPU and prevents the connector from

accidentally loosening (e.g. when connected to an HMI operator terminal).

Specifications	Q6HLD-R2	
Application	Programming cable QC30R2	
Order information	Art. no.	140381

Adapter Cables

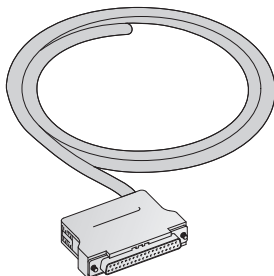

Assembled cable with D-SUB plug

The cables Q32CBL-3m and Q32CBL-5M are used for connecting the modules QX81 and QY81P of the MELSEC Q.

Specifications	Q32CBL-3M	Q32CBL-5M	Q32CBL-10M
Connection cable for	type QX81/QY81P	QX81/QY81P	QX81/QY81P
Length	m 3.0	5.0	10.0
Order information	Art. no. 136575	136576	158066

40-Pin Connectors

Connectors A6CON

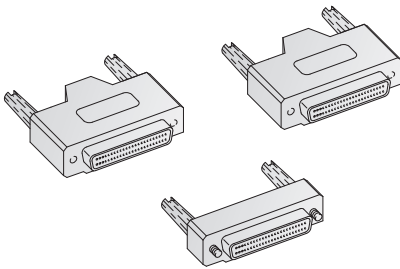

The 40-pin connectors are available in four different connection versions that differ in the way the leads are connected.

These connectors are required for all modules that connect to external signals via a 40-pin plug connection.

Whilst for the connectors A6CON-1 to A6CON-3 the cable is attached straight into the connector, in the case of the A6CON-4 the lead is angled.

Specifications		A6CON-2	A6CON-3	A6CON-4
Connector		Crimp-contact type	Pressure displacement type	Soldering type
Applicable wire size	mm ²	0,3	0,3	0,3
Order information	Art. no	134140	134141	146923

Connection Cables with Connectors

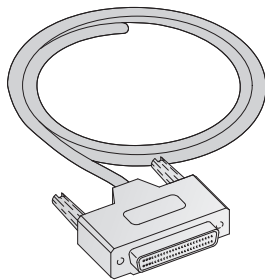

Assembled cables

The cables Q40CBL-3M and Q40CBL-5M serve as connecting cables for I/O modules with 40-pin plug connection.

The cables are prefabricated, i.e. a 40-pin connector is already attached to one cable end.

The cables FA-CBLQ75M□□ are ready made cables for the connection of the positioning modules QD75D1/D2/D4 or QD75P1/P2/P4 to a Mitsubishi servo amplifier MR-J2-Super or MR-C.

Specifications		Q40CBL-3M	Q40CBL-5M	Q40CBL-10M	FA-CBLQ75M2J2-P	FA-CBLQ75M2C-P	FA-CBLQ75PM2J2	FA-CBLQ75PM2C
Application range		All System Q modules with 40-pin connectors, like e.g. QX71, QX72, QY41P, QY42P			QD75D1/D2/D4 for connection with MELSERVO MR-J2-S	QD75D1/D2/D4 for connection with MELSERVO MR-C	QD75P1/P2/P4 for connection with MELSERVO MR-J2-S	QD75P1/P2/P4 for connection with MELSERVO MR-C
Specifications	m	3.0	5.0	10.0	2.0	2.0	2.0	2.0
Order information	Art. no.	140991	140997	158068	147697	147698	147699	147700

Memory Cards

MELSEC System Q memory cards

All System Q CPUs have a permanently installed RAM. This memory can be extended with a variety of external memory cards.



Specifications		Q2MEM-1MBS	Q2MEM-2MBS	Q2MEM-2MBF	Q2MEM-4MBF	Q2MEM-8MBA	Q2MEM-16MBA	Q2MEM-32MBA
Memory	type	SRAM	SRAM	Flash	Flash	ATA	ATA	ATA
Memory capacity		1 MB	2 MB	2 MB	4 MB	8 MB	16 MB	32 MB
Order information	Art. no.	127627	145399	127591	129646	129647	129648	129649

■ PCMCIA Adapter Unit

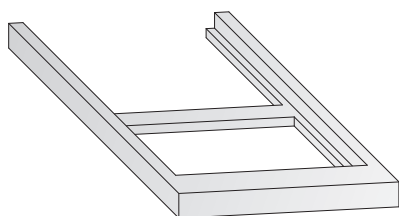

Memory card adapter

The memory card adapter Q2MEM-ADP is used for the PCMCIA slot of the PLC for data transferring.

Specifications		Q2MEM-ADP
For memory cards	type	All MELSEC Q memory cards
Order information		Art. no. 129650

■ Battery Q2MEM-BAT



Memory card buffer battery

The lithium battery Q2MEM-BAT is a replacement battery for the SRAM memory card Q2MEM-1MBS.

Specifications		Q2MEM-BAT
For memory card	type	Q2MEM-1MBS and Q2MEM-2MBS
Voltage	V DC	3.0
Capacity	mAh	48
Order information		Art. no. 129854

■ Battery Q6BAT

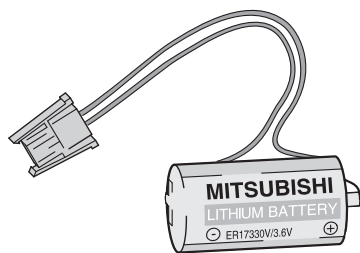

Buffer battery

The lithium battery Q6BAT is the replacement for the battery integrated for data backup in any MELSEC System Q CPU.

Specifications		A6BAT
Voltage	V DC	3,0
Capacity	mAh	1800
Dimensions (Ø x H)	mm	Ø16 x 30
Order information		Art. no 130376

DIN Rail Mounting Adapter

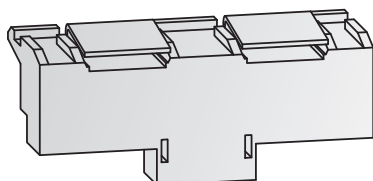
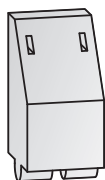

Adapter for mounting a MELSEC System Q on a DIN rail

The mounting adapter is used for easy and quick mounting the MELSEC Q base units on a DIN rail.

Specifications	Q6DIN1	Q6DIN2	Q6DIN3
For base units	Q38B/Q312B/Q68B/Q612B	Q35B/Q65B	Q33B/Q63B
Dimensions (W x H x D)	mm 328 x 98	245 x 98	198 x 98
Order information	Art. no. 129673	129674	136368

Interchangeable Terminal Blocks for I/O Modules

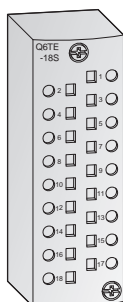

Terminal blocks for screw-less wiring

As an alternative to the standard screw terminal blocks for the input/output modules, there are two different screw-less terminal blocks available.

The spring clamp terminal block Q6TE-18S permits the connection of single or multiple-wire copper conductors, whereby the stripped cable ends are pressed vertically

into the terminal and are held by a traction spring.

In the case of the Q6TA32 terminal block, contact is made by pressing in the wire with the optional insertion tool without having to strip the wire first. This allows for rapid wiring of the terminals.

Specifications	Q6TE-18S	Q6TA32
Type	Spring clamp terminal block	IDC terminal block adapter
Applicable modules	All System Q modules with terminal block for 18 screw terminals	QX41, QX71, QY41P, QY71
Applicable wire size	mm ² 0.3 – 1.5	0.5
Weight	kg 0.07	0.08
Order information	Art. no. 141646	145034
Accessory	—	Insertion tool Q6TA32TOL, art. no.: 145035

Extension Device Box

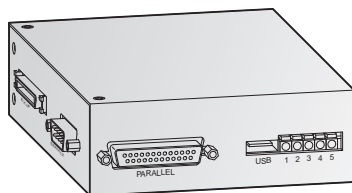

Extension by additional interfaces

Each extension device box extends the PC-CPU by one RS232, one USB, and one parallel interface.

Furthermore, additional potential free remote contacts are included which support e.g. the polling of the watchdog timer or a remote shutdown.

The extension device box is connected to the "EX I/F" connector on the front panel of the CPU module.

Specifications	PPC-COT-01	PPC-DINAD-01
Type	Interface extension box	DIN-rail mounting adapter for the extension device box
Interface	1 x RS232, 1 x USB, 1 x parallel	
Order information	Art. no. 139819	140127

Memory Media for Q-PC

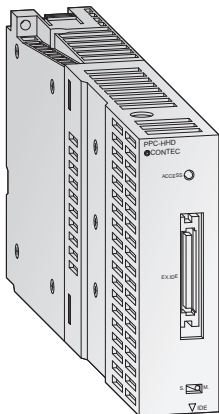

Memory units

8 different disk drives are available for the Q-PC that can be inserted additionally into the base unit directly beside the CPU module. The connection to the CPU is established via a short cable link underneath the modules.

Besides a conventional hard disk with a storage capacity of 5 GB a number of so called silicon disks for the use under ambient conditions subject to strong vibrations or shocks is available.

Specifications	PPC-HDD (MS)A	PPC-CF-1GB-R
Type	Hard disk	CF Card
Memory capacity	20 GB	1 GB
Order information Art. no.	207879	207880
Accessories	Hard disk vibration protection PPC-HBR-01; art. no.: 140126	

4 ACCESSORIES

External Drive for Q-PC

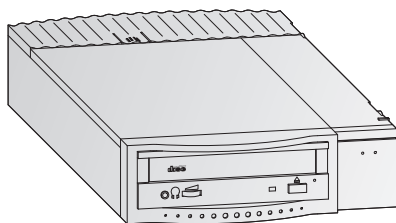

Disk drives

For the Q-PC a special external floppy disk drive and a special CD-ROM drive are available.

The drives provide their own casing and are connected to the Q-PC via cable.

Specifications	PPC-IPC-CDD-02
Type	CD/DVD-ROM
Description	external drive incl. cable
Order information Art. no.	207881

Cable

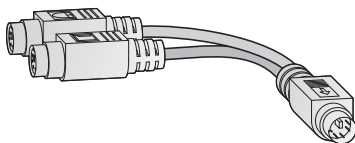

If both, mouse and keyboard are intended to be connected at the same time, the Y-adapter PPC-YCAB-01 is required.

The cable PPC-SCC-01 extends the Q-PC by one serial interface.

Specifications	PPC-YCAB-01	PPC-SCC-01
Type	Mouse and keyboard cable	Cable for 2nd serial interface
Design	PS/2 Y cable	EX/IF connection to 9-pin D-Sub
Order information Art. no.	140484	139820

Power Supply Modules

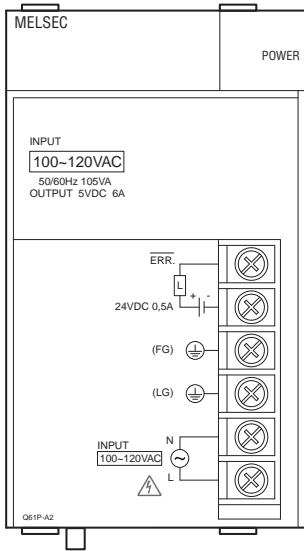

Q61P-A1

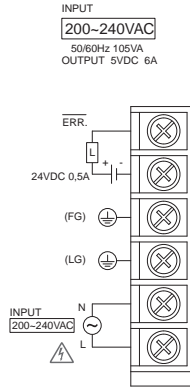

Q61P-A2

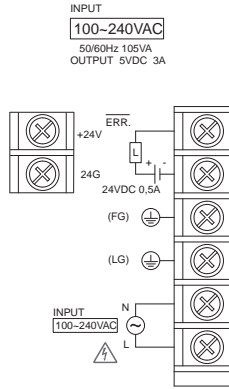

Q62P

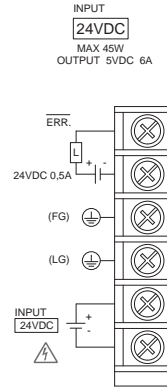

Q63P

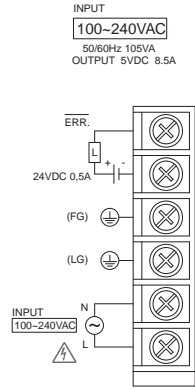

Q64P

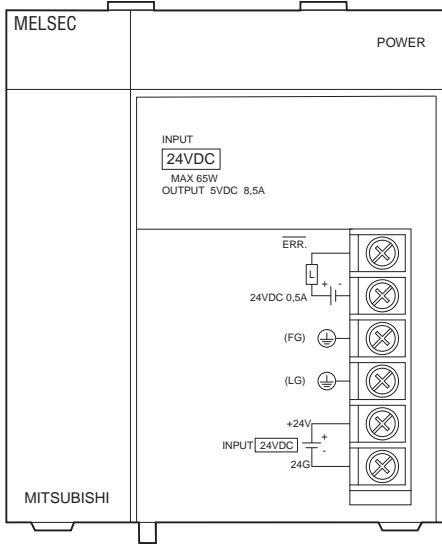

Q63RP

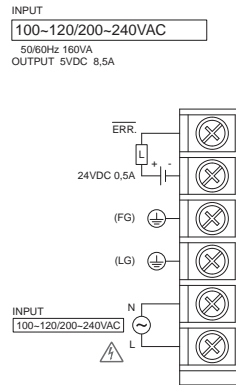

Q64RP

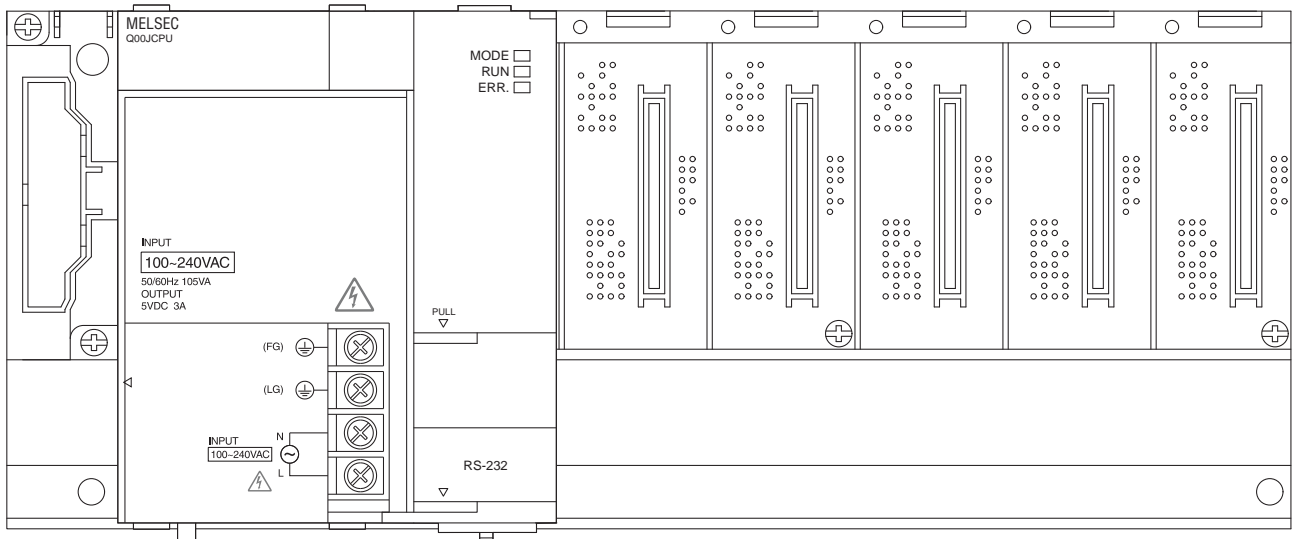

Q00JCPU

■ Digital input Modules

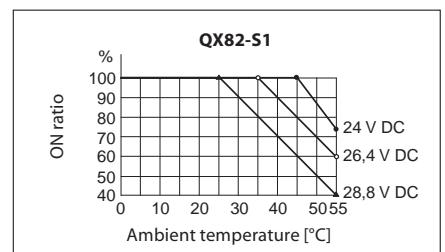
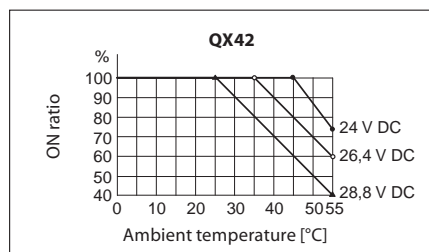
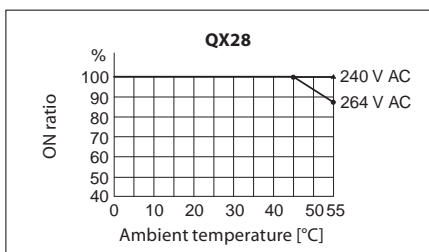
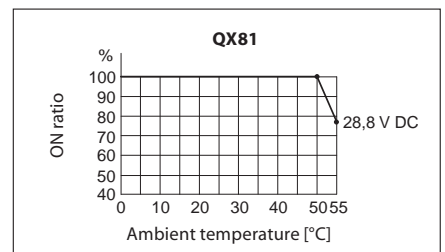
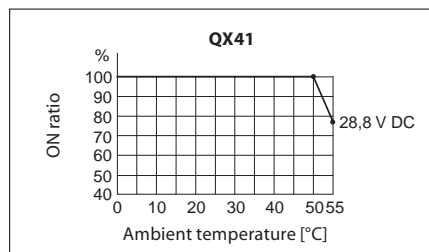
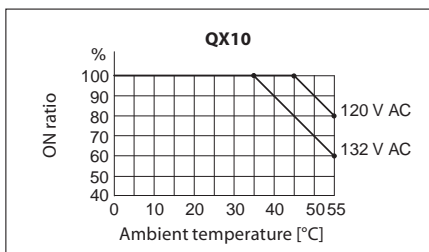
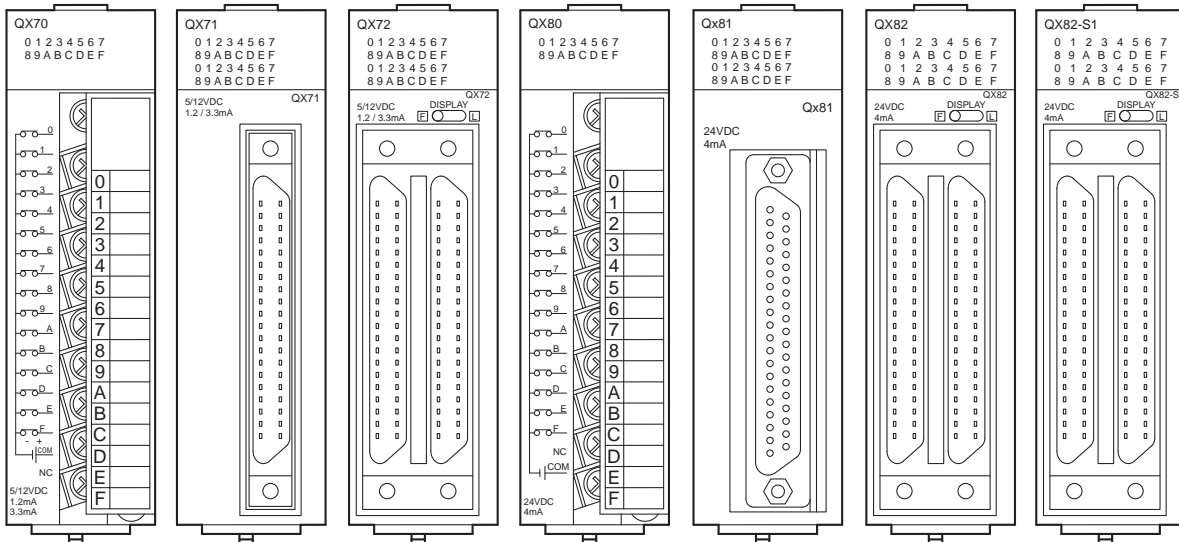
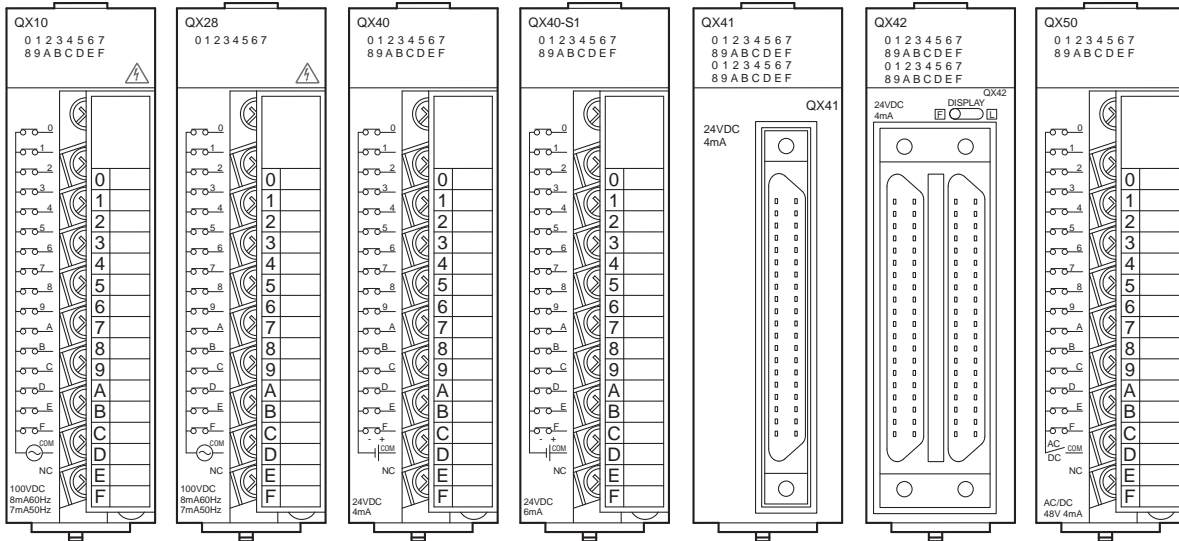

Digital Output Modules

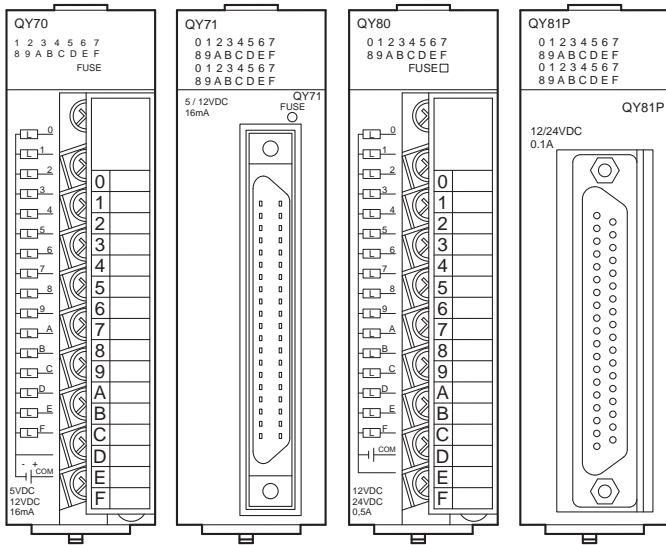
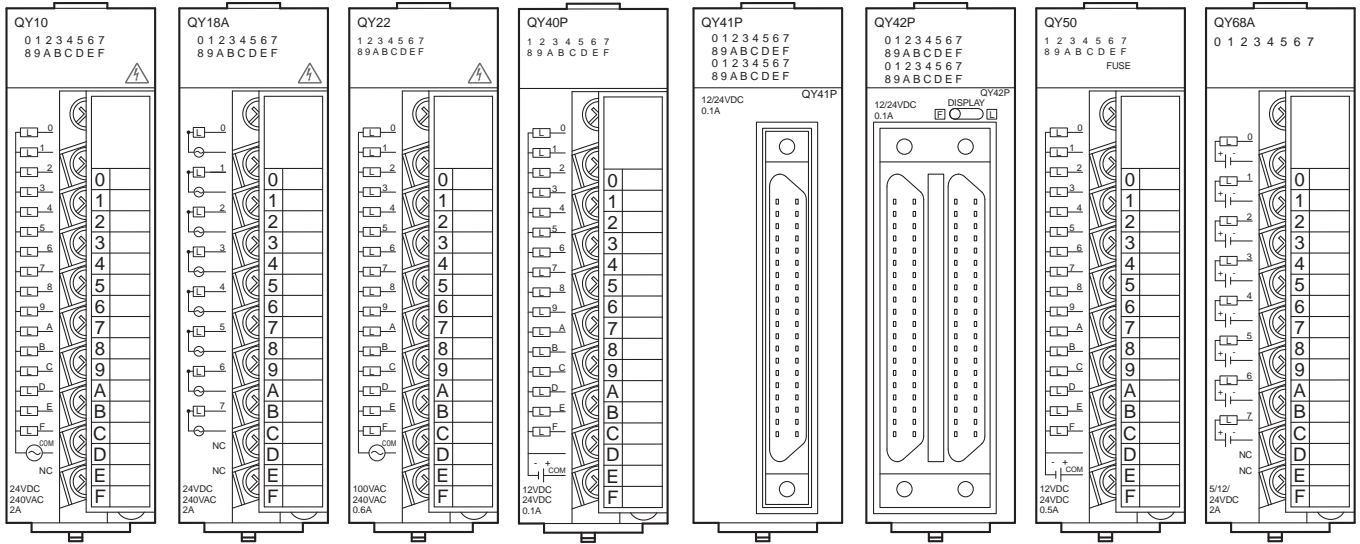

■ Analog Input/Output Modules

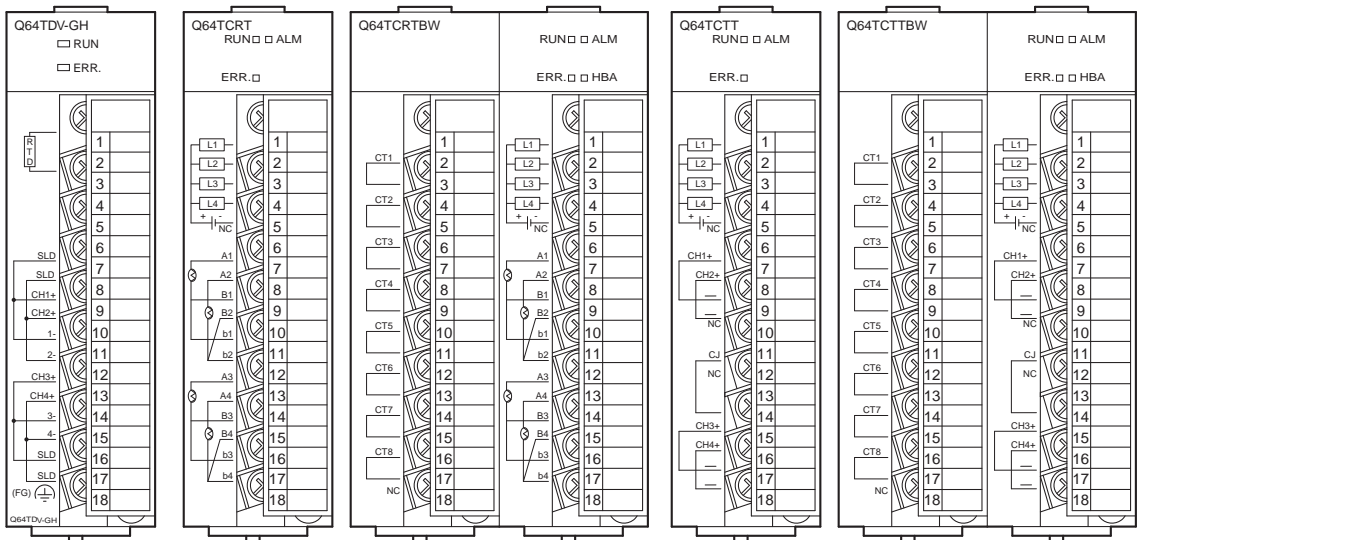
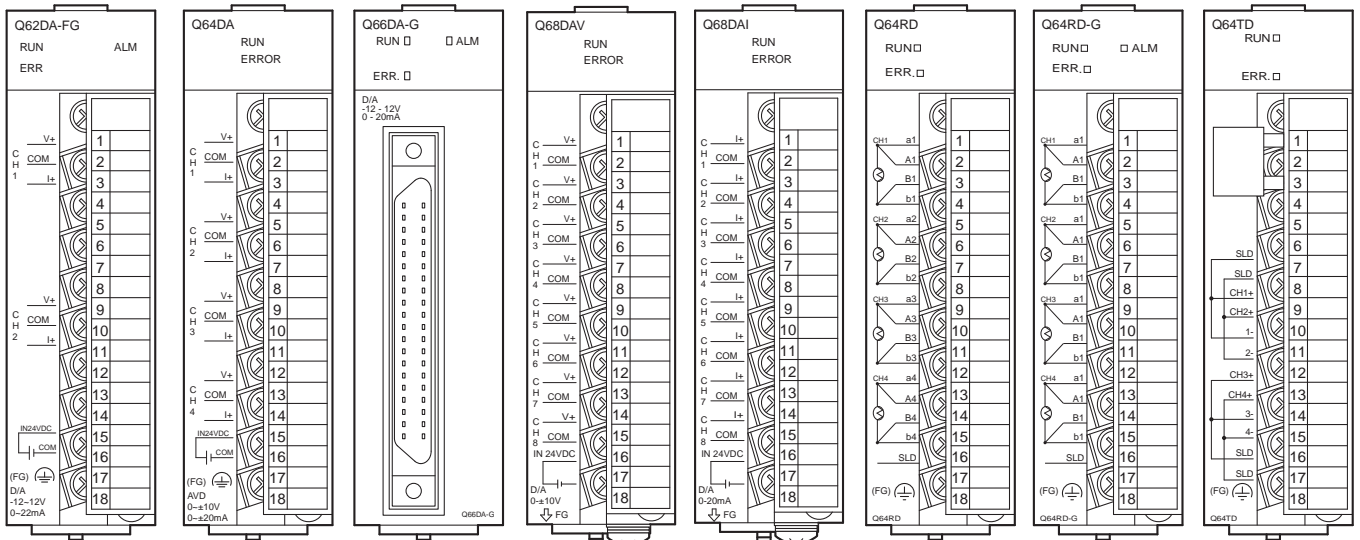
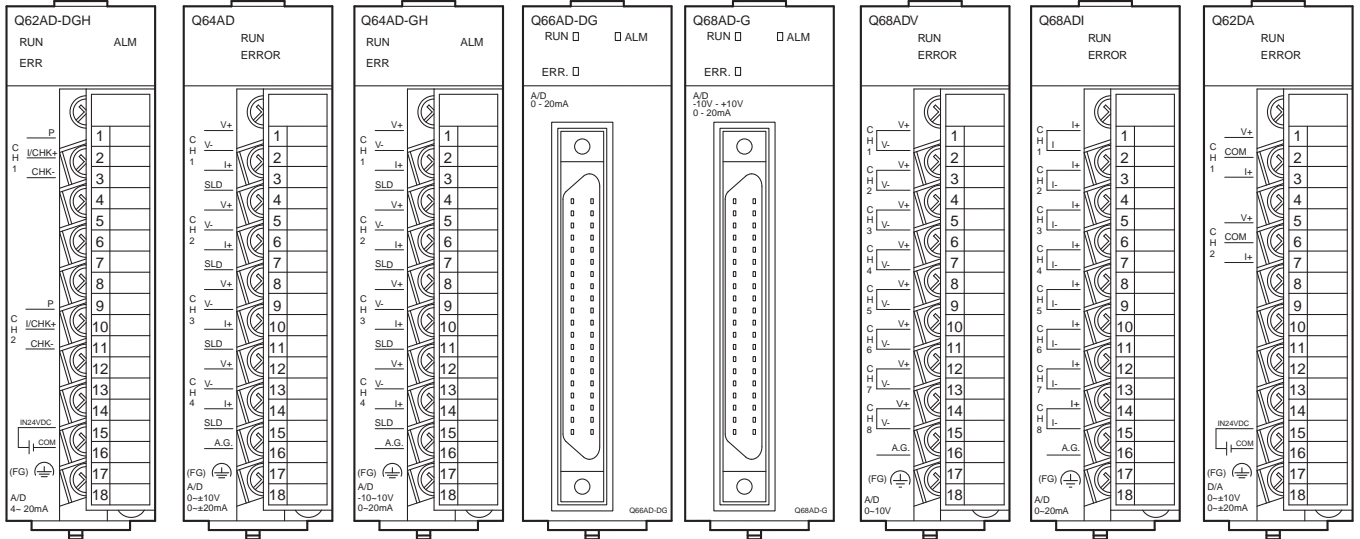

5
TERMINALS AND DIMENSIONS

Special Function Modules

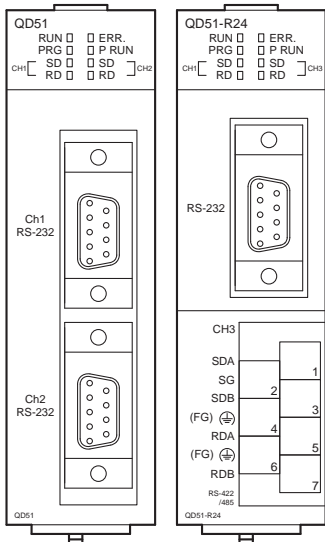
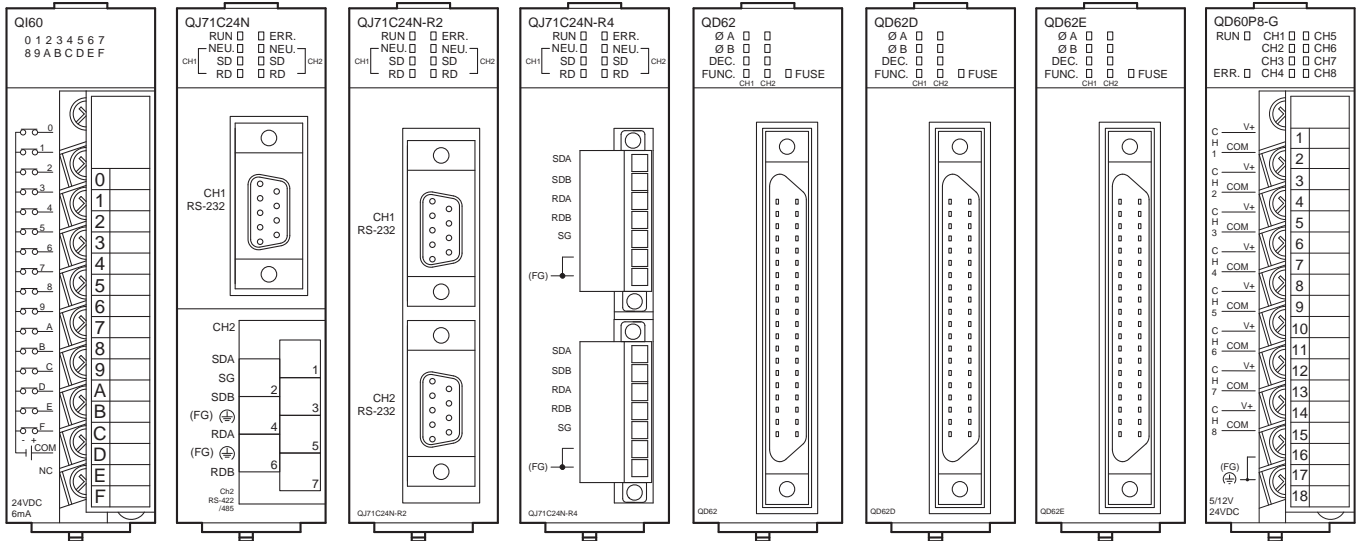

Positioning Modules

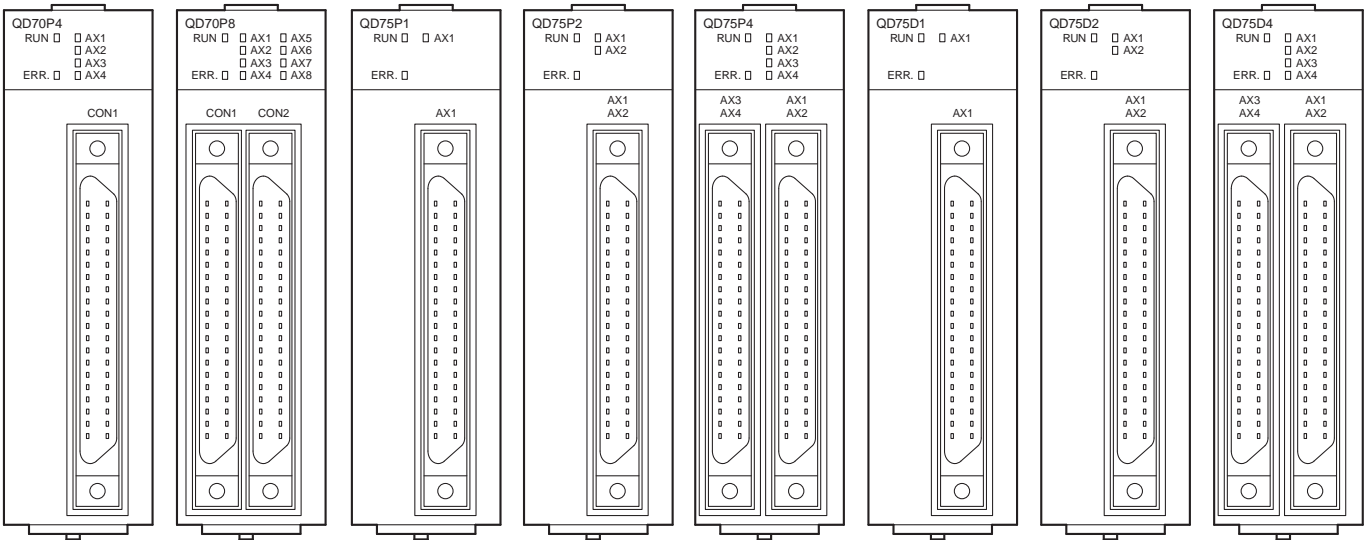

■ Base Units

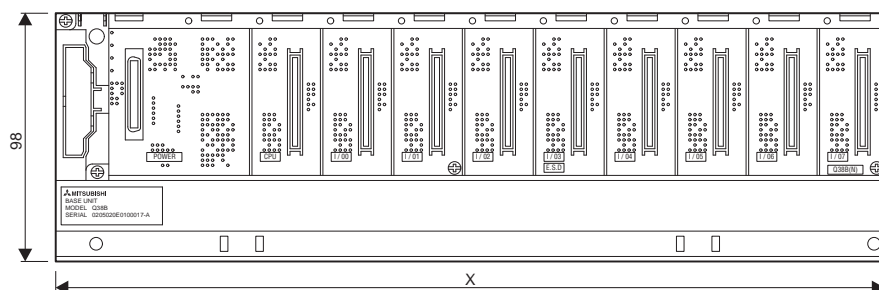

Type	X (in mm)
Q33B	189
Q35B	245
Q38B	328
Q312B	439
Q52B	106
Q55B	189
Q63B	189
Q66B	245
Q68B	328
Q612B	439
Q00JCPU-E	245

■ Base Units (with redundant power supply)

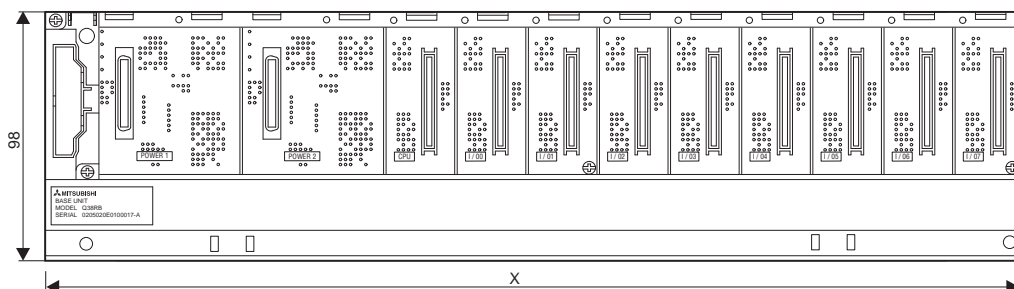

Type	X (in mm)
Q38RB	439
Q68RB	439

■ CPUs and Power Supply Modules

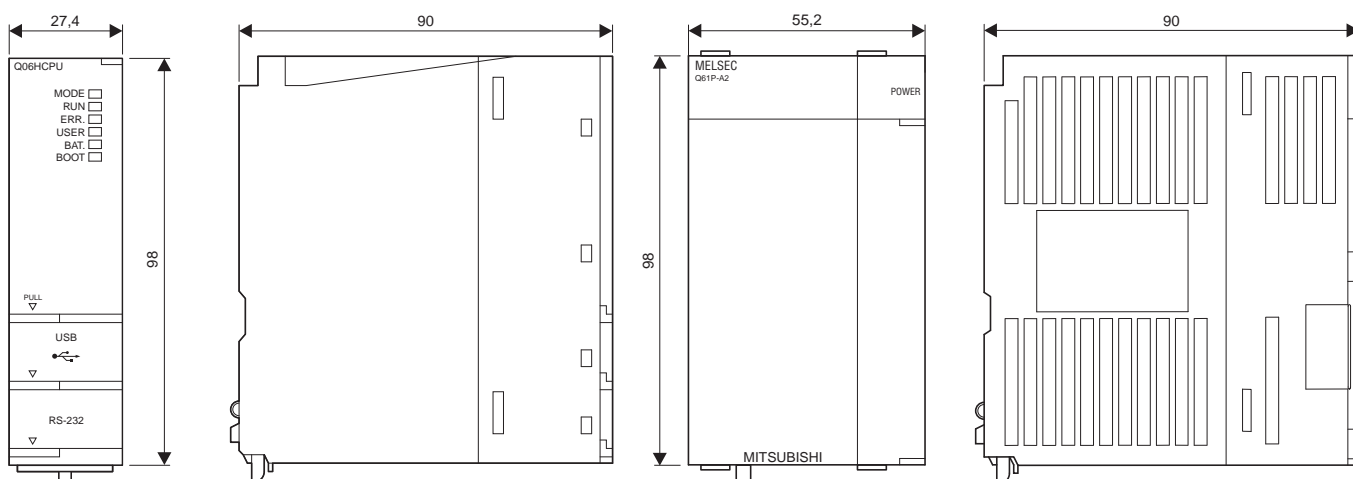

■ CPUs and Power Supply Modules (redundant)

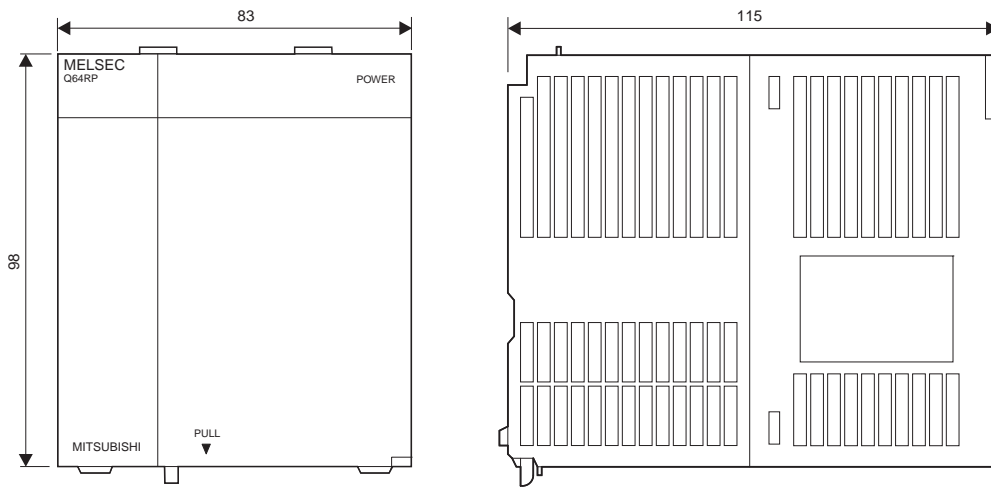
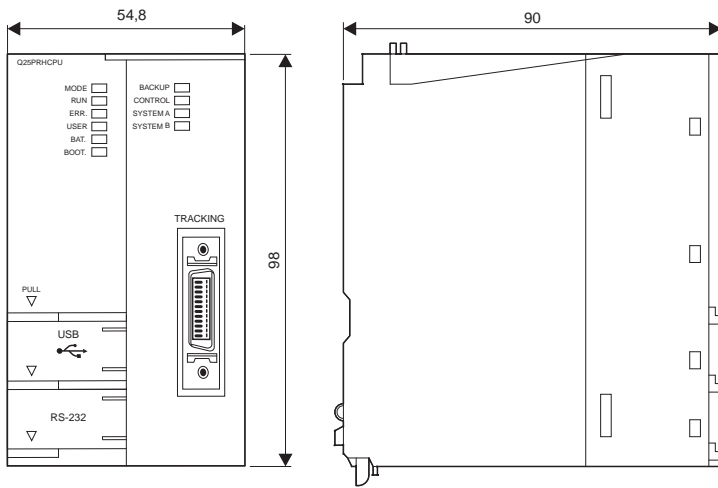

■ I/O Modules and Special Function Modules

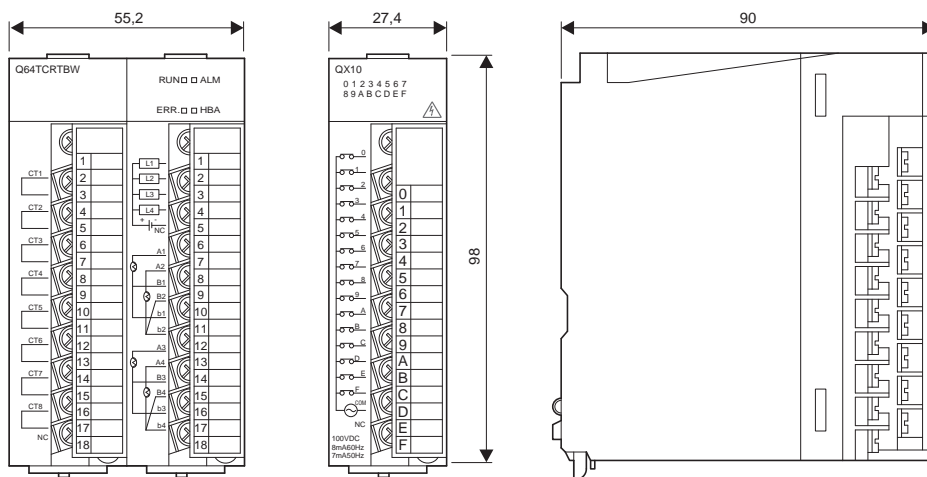

5
TERMINALS AND DIMENSIONS

■ System Terminals

ST32 / ST-32-Diod

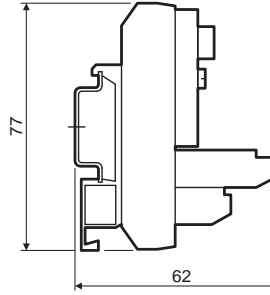
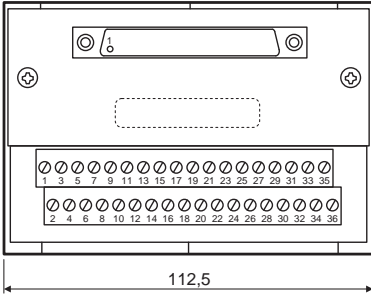

ST32-3

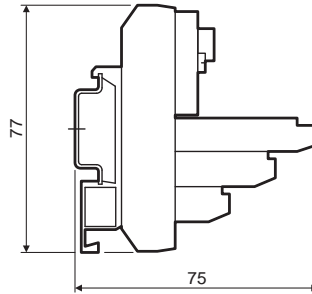
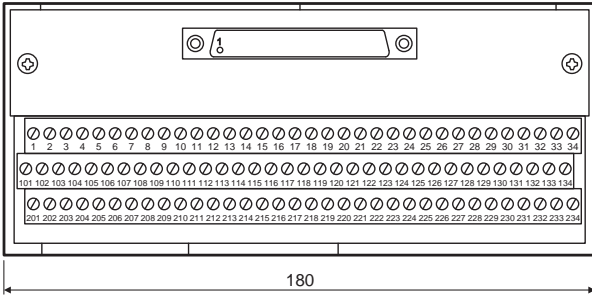

ST16-Socket

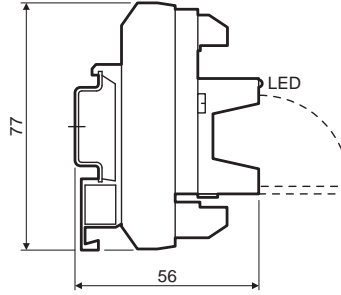
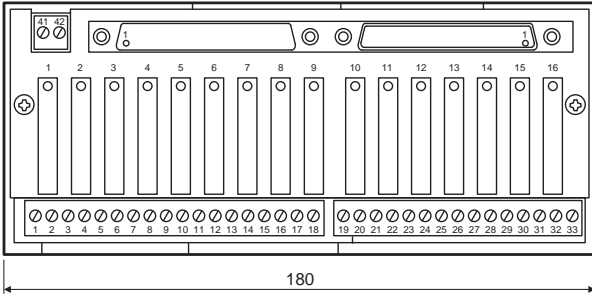

ST16-3

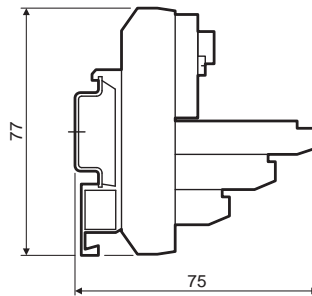
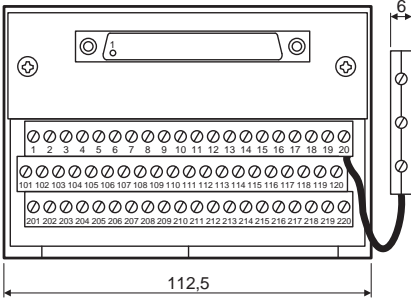

ST40

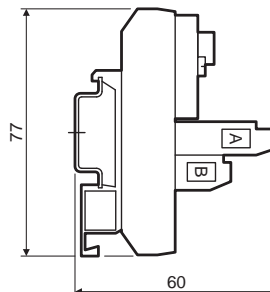
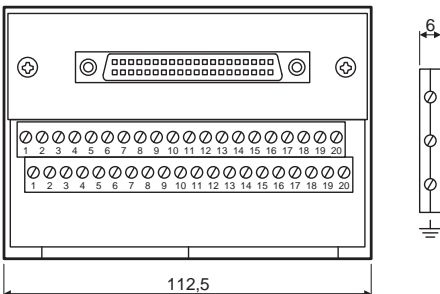

Terminal Block Adapters

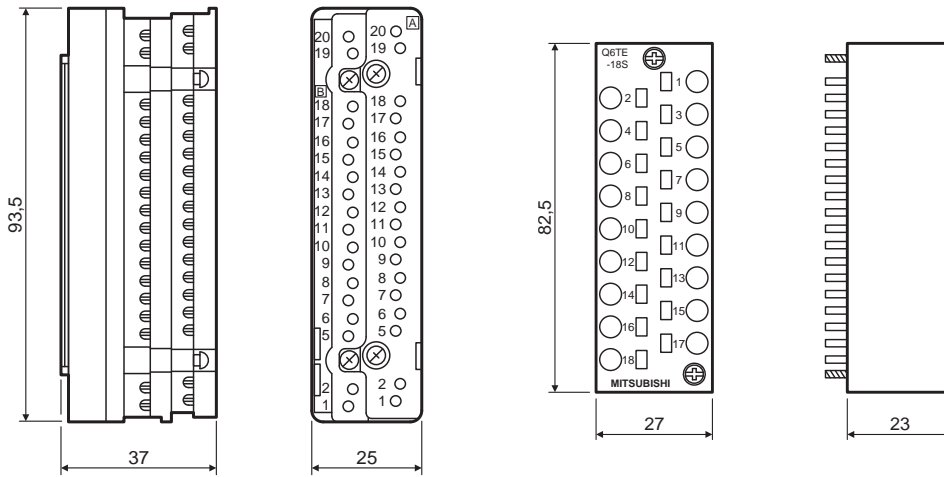

Connectors

A6CON2

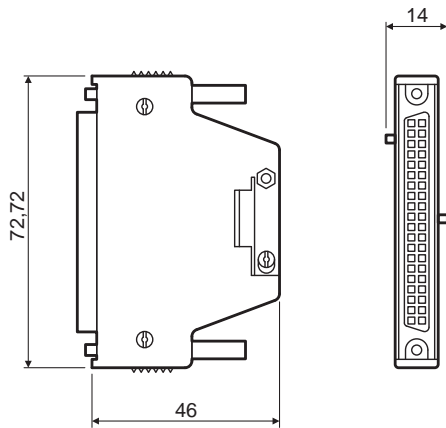

A6CON4

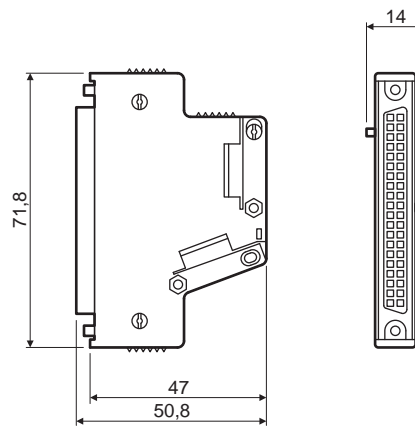

A6CON3

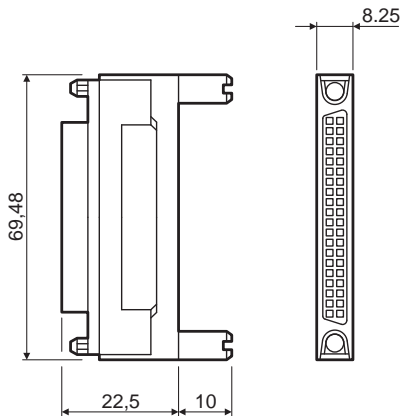

MELSOFT – Programming and Documentation Software for Standard Personal Computers



With the MELSOFT software family Mitsubishi Electric offers efficient software packages helping to reduce programming and setup times to a high degree.

The MELSOFT software family provides instant access, direct communications, compatibility, and open exchange of variables.

The MELSOFT family comprises:

- Programming packages like GX Developer and GX IEC Developer
- Network configuration software like for example GX Configurator DP
- Visualization software like for example MX Scada
- Software for a dynamic data exchange like MX Change
- Various development software for operator terminals (please refer to the Technical Catalogue HMI)

GX Developer is recommended as a costeffective beginners package for the MELSEC System Q. This package offers a quick and easy introduction to programming.

For structured programming the IEC 1131 (EN 61131) conform programming software GX IEC Developer is recommended.

For detailed information please order our separate MELSOFT brochure.

■ GX Developer

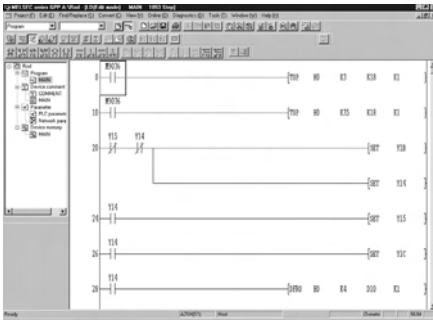

GX Developer is the standard programming software for all MELSEC PLC series with the user guidance of Microsoft Windows.

With this software you can comfortably create PLC programs alternatively in the form of Ladder Diagrams or Instruction Lists. Both forms of representation can be toggled easily during operation.

Besides efficient monitoring and diagnostics functions GX Developer features an offline simulation of any PLC type.

With GX Developer all MELSEC PLCs from the FX1S to the Q25H are supported. The

use of GX Developer FX is limited to the PLCs of the FX family.

This software provides all the Windows-specific advantages and is especially suited to all MELSEC PLCs.

GX Developer can be run under Windows 95/98/XP and Windows NT/2000.

The software is supplied without a programming cable, which has to be ordered separately if required and which is used for the connection between the PLC and a serial interface of a personal computer.

Software	GX Developer V0800-1LOC-G	GX Developer V0800-1LOC-E	PX Developer V0100-1LOE-E
Series	All MELSEC PLCs (except FX3U)	All MELSEC PLCs	Optional for process CPUs in combination with GX Developer
Language	German	English	English
Order information	Art. no. 152816	150420	162370
Accessories	Programming cable QC30R2, art. no.: 128424; QC30-USB, art. no.: 136577		

■ GX IEC Developer



GX IEC Developer provides all functions of the pre-mentioned programs and in addition meets the programming standard for the future: IEC 1131.3 (EN 61131). This makes the software ready for the programming standard of the future and offers as a basis for the on-leading programming of the MELSEC A and MELSEC system Q.

GX IEC Developer can be run under Windows 95/98/XP and Windows NT/2000.

The software is supplied without a programming cable, which has to be ordered separately if required and which is used for the connection between the PLC and a serial interface of a personal computer.

Software	GX IEC Developer V0700-1LOC-G	GX IEC Developer V0700-1LOC-E
Series	All MELSEC PLCs	All MELSEC PLCs
Language	German	English
Order information	Art.-Nr. 167452	167458
Accessories	Programming cable QC30R2, art. no.: 128424; QC30-USB, art. no.: 136577	

Software for Process Visualisation and for Dynamic Data Exchange

■ MX Change



MX Change is integrated in the MELSOFT family as the "heart of automation". The software package consists of a Server and a Super Projekt Manager, other automation programs can be connected to. Since MX Change operates across a network, any variable once declared can be used by all other systems connected to the database.

Through this method following the principle "define once and use anywhere" the development time can even be decreased drastically.

The software runs under Windows 95 and Windows NT/2000.

Software	MX Change V0220-1LOC-E	MX Change 2000T V0220-0LOC-DEMO
Language	English	English
Executable tags		2000
Disk type	CD ROM	CD ROM
Order information	Art. no. 146559	146561

■ MX OPC Server



The OPC standard was developed for manufacturer independent communications between processes and Microsoft Windows® applications in client/server architecture.

OPC means "OLE for Process Control" and represents an application of the Microsoft DCOM technology (Distributed Component Object Model). In contrast to Active-X the OPC based data exchange especially features a higher performance.

The MX OPC server is a standardized software interface that enables Microsoft Windows® applications to access a Mitsubishi PLC quick and easily.

The software runs under Windows 95/98 and Windows NT/2000.

Software	MX OPC Server V0400-1LOC-E
Series	All MELSEC PLCs
Language	English
Disk type	CD ROM
Order information	Art. no. 139793

■ MX Components

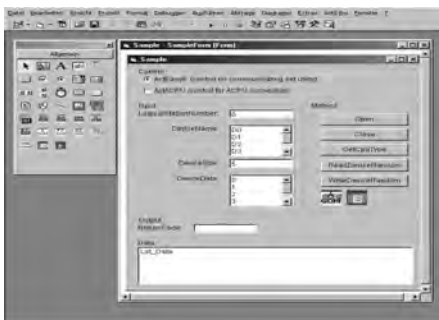

This software provides you with powerful Active-X elements. An internal driver manages the complete communications between your Microsoft Windows application and your process. Via MX components and a programming language (e.g. Visual Basic, Visual C++, etc.) you can easily create your own PC applications or integrate existing PC applications.

Moreover, via MX Components and VBA the complete MS Office range is at your service. Without high effort you can integrate online process data of a Mitsubishi PLC in your existing office software (e.g. MS Access or MS Excel etc.).

The software runs under Windows 95/98 and Windows NT/2000.

Software	MX Components V0300-1LOC-E
Series	All MELSEC PLCs
Language	English
Disk type	CD ROM
Order information	Art. no. 142848

■ MX4 SCADA

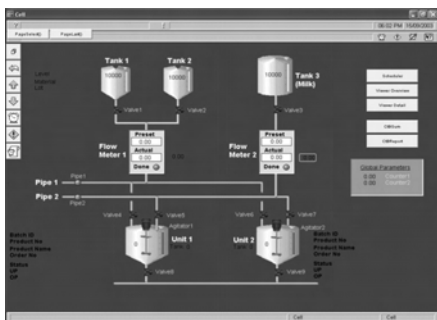

MX4 SCADA is a process visualisation system that can handle everything from simple installations to complex production control systems. The software package can administer an almost unlimited objects. MX4 HMI is designed for small applications where there is no need for an extensive networked solution. However, if the application expands then it is easy to upgrade to MX4 SCADA.

Also included with MX4 SCADA/MX4 HMI is FastLinx, a communication and data exchange tool that make set-up simple and directly links MX4 to GX IEC Developer to ensure consistent use of PLC devices. The software runs under MS Windows® 95/98/NT4/2000 and XP and is available in a variety of different versions geared to the objects to be handled.

Software	Development version		Run-time version
Series	All MELSEC PLCs		All MELSEC PLCs
Language	English		English
Disk type	CD ROM		CD ROM
Order information	Art. no.	On request	On request

Software for PROFIBUS Networks

■ GX Configurator DP

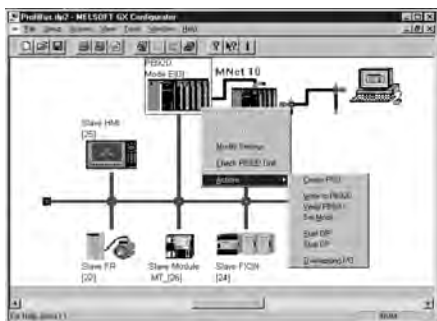

The Software GX Configurator DP is a user friendly configurations software for the open network PROFIBUS/DP. The software package is a 32 bit application and runs under Windows 95/98 and Windows NT4.0. Configuration of all PROFIBUS modules for the System Q, AnSH/QnAS series and also the FX family is possible. Due to the supported extended user parameters of a GSD file, easy parameter

setting of PROFIBUS/DP slave devices is possible even for third party devices. The new GX Configurator DP enables the download of all configuration data via an overriding network. All PROFIBUS modules are configured via the backside bus.

Software	GX Configurator DP V0700-1LOC-E		
Supported Profibus/DP master modules for the Mitsubishi MELSEC series	A1S171PB92D, QJ71PB92D, QJ71PB92V		
Language	English / German		
Order information	Art. no.	155928	
Accessories	Programming cable QC30R2, art. no.: 128424; QC30-USB, art. no.: 136577		

A6CON	37	Q38B-E	12	QX80	19
Accessories	34	Q312B-E	12	QX81	19
Adapter cables	37	Q40-ST40-CAB□M	35	QX82	19
Analog modules	22	Q40CBL-□M	37	QX82-S1	19
Base units	12	Q52B	12	QY10	20
Battery	38	Q55B	12	QY18A	20
Cable		Q61P-A1	13	QY22	20
common	37	Q61P-A2	13	QY40P	20
for system terminals	35	Q62AD-DGH	23	QY41P	20
Q PC	41	Q62DA	24	QY42P	20
Communications modules	31	Q62DA-FG	24	QY50	20
Connection cables	37	Q62E-CAB-□M	37	QY68A	20
Connector disconnection prevention	36	Q62P	13	QY70	20
Connectors	37	Q63B	12	QY71	20
Counter modules	27	Q63P	13	QY80	20
CPU modules	14	Q64AD	22	QY81P	20
Digital input/output modules	18	Q64AD-GH	23	Q-PC	
Dimensions	47	Q64DA	24	CPU module	16
DIN rail mounting adapter	39	Q64P	13	memory units	40
Drives (Q-PC)	40	Q64RD(-G)	25	cables	35
Dummy module	34	Q64TCRT	26	drives	40
Extension device box (Q-PC)	40	Q64TCRTBW	26	Software	
Interface modules	31	Q64TCTT	26	GX Configurator DP	53
Interrupt module	33	Q64TCTTBW	26	GX (IEC) Developer	50
I/O modules	18	Q64TD	25	GX Monitor DP	53
Memory cassettes	38	Q64TDV-GH	25	MX Change	51
Memory units (Q-PC)	40	Q65B	12	MX Components	52
Motion CPUs	17	Q68ADI	22	MX OPC Server	51
Network		Q68ADV	22	MX SCADA	52
network modules	**	Q68B	12	PROFIBUS Mastersimulator	53
overview	8	Q68DAV	24	Spring clamp terminal block	39
accessories	**	Q68DAI	24	System terminals	
PCMCIA adapter	38	Q172CPUN	17	description	35
Positioning modules	28	Q173CPUN	17	dimensions/assignment	48
Power supply	13	Q612B	12	Terminal assignment	42
PPC-CDD-01	40	QC05B	36	Terminal block adapter	39
PPC-COT-01	40	QC06B	36		
PPC-CPU686(MS)128	16	QC12B	36		
PPC-DINAD-01	40	QC30B	36		
PPC-FDD25BH	40	QC30R2	36		
PPC-HDD	40	QC30-USB	36		
PPC-SDD	40	QC50B	36		
PPC-SSC-01	41	QC100B	36		
PPC-YCAP-01	41	QD51	32		
Programming cable	36	QD51S-R24	32		
Programming software	50	QD60P8-G	27		
Q00JCPU-E	14	QD62	27		
Q00CPU	14	QD62D	27		
Q01CPU	14	QD62E	27		
Q02CPU	15	QD70P4	28		
Q02HCPU	15	QD70P8	28		
Q06HCPU	15	QD75D1	30		
Q2MEM	38	QD75D2	30		
Q2MEM-ADP	38	QD75D4	30		
Q2MEM-BAT	38	QD75P1	29		
Q6BAT	39	QD75P2	29		
Q6DIN	39	QD75P4	29		
Q6HLD-R2	36	QD75M1	30		
Q6TA32	39	QD75M2	30		
Q6TE-18S	39	QD75M4	30		
Q12HCPU	15	QG60	34		
Q12PHCPU	15	QI60	33		
Q16-ST-CAB□M	35	QJ71C24N	31		
Q25HCPU	15	QJ71C24N-R2	31		
Q25PHCPU	15	QJ71C24N-R4	31		
Q32-ST-CAB□M	35	QX10	18		
Q32CBL-□M	37	QX28	18		
Q33B-E	12	QX40	18		
Q35B-E	12	QX40-S1	18		
		QX41	18		
		QX41-S1	18		
		QX42	19		
		QX42-S1	19		
		QX70	19		
		QX71	19		
		QX72	19		

A world of automation solutions

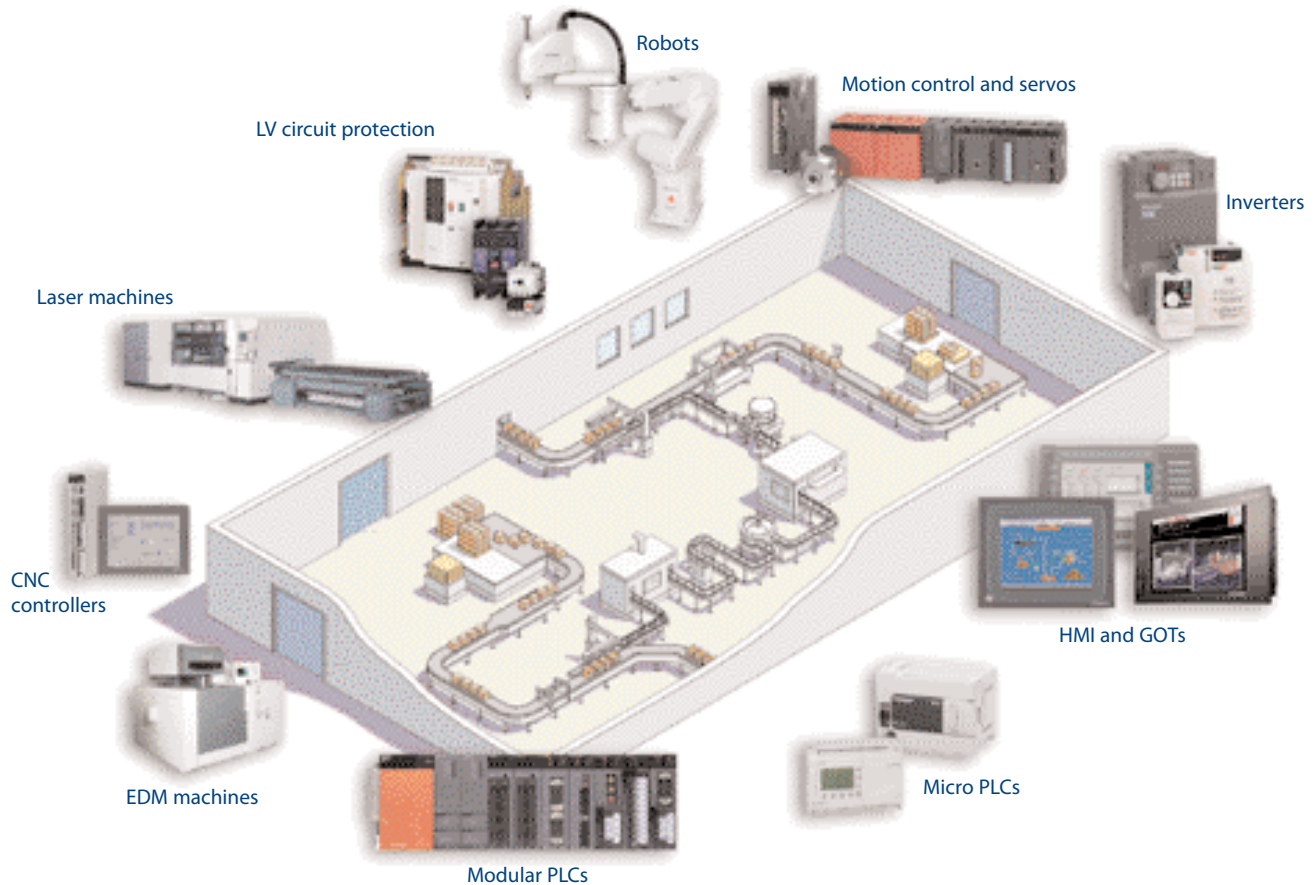

Mitsubishi offer a wide range of automation equipment from PLCs and HMIs to CNC and EDM machines.

A name to trust

Since its modest beginnings in 1870, Mitsubishi has long since emerged as one of the world's leading companies, with 45 subsidiaries specializing in finance, commerce and industry. A symbol of premium quality, the Mitsubishi brand name is recognized around the world. Mitsubishi Electric Corporation is active in aerospace, transportation, semiconductors, energy systems, communications and information processing, audiovisual equipment, home electronics, building and energy management and automation systems, with 237 factories and laboratories in over 121 countries. You can rely on Mitsubishi automation solutions because we know firsthand the need for reliable, efficient, easy-to-use automation and control systems.

With global sales of approximately \$30.8 billion and over 100,000 committed employees, Mitsubishi Electric has the resources needed to deliver the world's best products and the ultimate in service and support. Today Mitsubishi supplies a wide range of automation equipment extending from PLCs and HMIs to CNC and EDM machines.

Global Partner. Local Friend.

EUROPEAN SERVICE GROUP
MITSUBISHI ELECTRIC EUROPE B.V.
Gothaer Str. 8
D-40880 RATINGEN
Free European Hotline:
+49 (0) 1805 000 765
Training Hotline:
+49 (0) 2102 486 1880
**EUROPEAN
DEVELOPMENT CENTER**
MITSUBISHI ELECTRIC EUROPE B.V.
Gothaer Str. 8
D-40880 RATINGEN

FRANCE
MITSUBISHI ELECTRIC EUROPE B.V.
25, Boulevard des Bouvets
F-92741 NANTERRE CEDEX
Phone: +33 (0)1 / 55 68 55 68
GERMANY
MITSUBISHI ELECTRIC EUROPE B.V.
Gothaer Str. 8
D-40880 RATINGEN
Phone: +49 (0) 1805 000 765
Training: +49 (0) 2102 486 1880
**Kunden-Technologie-Center
Dortmund**
Phone: +49 (0) 231 96 70 41 0
Filderstadt
Phone: +49 (0) 711 77 05 98 0
Hallbergmoos
Phone: +49 (0) 811 99 87 4 0

UNITED KINGDOM
MITSUBISHI ELECTRIC EUROPE B.V.
Travellers Lane
UK-HATFIELD, HERTS. AL10 8 XB
Phone: +44 (0) 17 07 27 61 00
Training:
+44 (0) 17 07 27 89 16
**Customer Technology Centre,
Hatfield**
Phone: +44 (0) 17 07 27 89 90
**Regional Automation Center,
Wakefield**
Phone: +44 (0) 1924 255 628

IRELAND
MITSUBISHI ELECTRIC EUROPE B.V.
Westgate Business Park,
Ballymount
IRL-DUBLIN 24
Phone: +353 (0)1 4198800
ITALY
MITSUBISHI ELECTRIC EUROPE B.V.
Viale Colleoni 7
I-20041 AGRATE BRIANZA (MI)
Phone: +39 039 / 60 53 1

SPAIN
MITSUBISHI ELECTRIC EUROPE B.V.
Carretera de Rubi 76-80
**E-08190 SANT CUGAT DEL
VALLÉS (BARCELONA)**
Phone: +34 93 / 565 3131

For more information about our partners across Europe, please visit the contacts page of our internet site at www.mitsubishi-automation.com



Mitsubishi Electric Europe B.V. /// FA - European Business Group /// Gothaer Strasse 8 /// D-40880 Ratingen /// Germany
Tel: +49 (0) 2102 4860 /// Fax: +49 (0) 2102 4861120 /// info@mitsubishi-automation.com /// www.mitsubishi-automation.com

Specifications subject to change without notice /// Art-Nr. 201288-A /// 10.2007

All trademarks and copyrights acknowledged.