





# *User's Guide - Devireg™ 550 Thermostat*



1

## **About the thermostat**

Pages 2 - 7

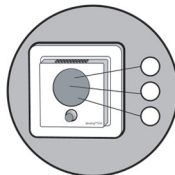

2

## **Set weekday and clock**

Pages 8 - 9

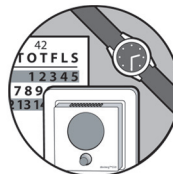

3

## **Set temperature**

Pages 10 - 11

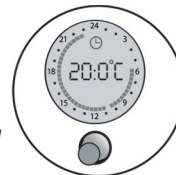

4

## **Set periods with lowering of temperature**

Pages 12 - 14



## **Congratulations!**

You have purchased a Devireg™ 550 thermostat, which forms an integral part of your DEVI™ system.

DEVI has developed the Devireg 550 in order to make your floor heating system and the heating of your home as economical and environmentally friendly as possible.

Devireg™ 550 works dynamically with both the room and floor temperature in order to ensure optimum efficiency, giving you the highest possible comfort in the most economical way.

Once the Devireg 550 has been installed for a few days, it will fully optimise the use of the heating system. It will then continue to learn from the room, thus constantly improving its performance, as well as your comfort and economy.

We wish you many years of comfort with your new DEVI™ system.

## **Warning**

**⚠** Do not cover the thermostat, for instance by hanging towels etc. directly in front of it.

Please note, it is not advisable to leave certain insulative objects on the same spot as this can cause 'hot spots' on your floor.



## About the thermostat

1

### Introduction

Devireg™ 550 is an adaptive temperature controller, specially designed for floor heating systems. It can, however, also be used for other heating systems (e.g. with power heating units).

2

The Devireg™ 550 will measure the radiant comfort from the floor combined with the comfort from the air temperature in the room to offset the outside weather condition. This means that as soon as you have set your Devireg™ 550 at your desired comfort temperature, Devireg 550 will then automatically adjust the heating to meet your comfort levels, regardless of changing weather conditions.

3

Devireg™ 550 is also capable of detecting a sudden temperature drop in the room. Instead of switching the heating on to immediately compensate, the Devireg™ 550 uses the information stored and then checks if this sudden drop of

4

temperature may be caused by for instance a window that has been opened for 10 minutes.

Even the programming of economy temperatures (i.e. lowering of temperature during the night and when you are at work) is very simple. You do not have to calculate how much earlier the heating should start in order to reach a specific temperature at a specific time. Just tell the Devireg™ 550 when you want the comfort temperature, and the Devireg™ 550 will take care of the rest. By identifying the rate of heat loss from the room, the Devireg™ 550 knows when to start heating in order to achieve the selected temperature at exactly the right time.

Devireg™ 550 - the thermostat that thinks!

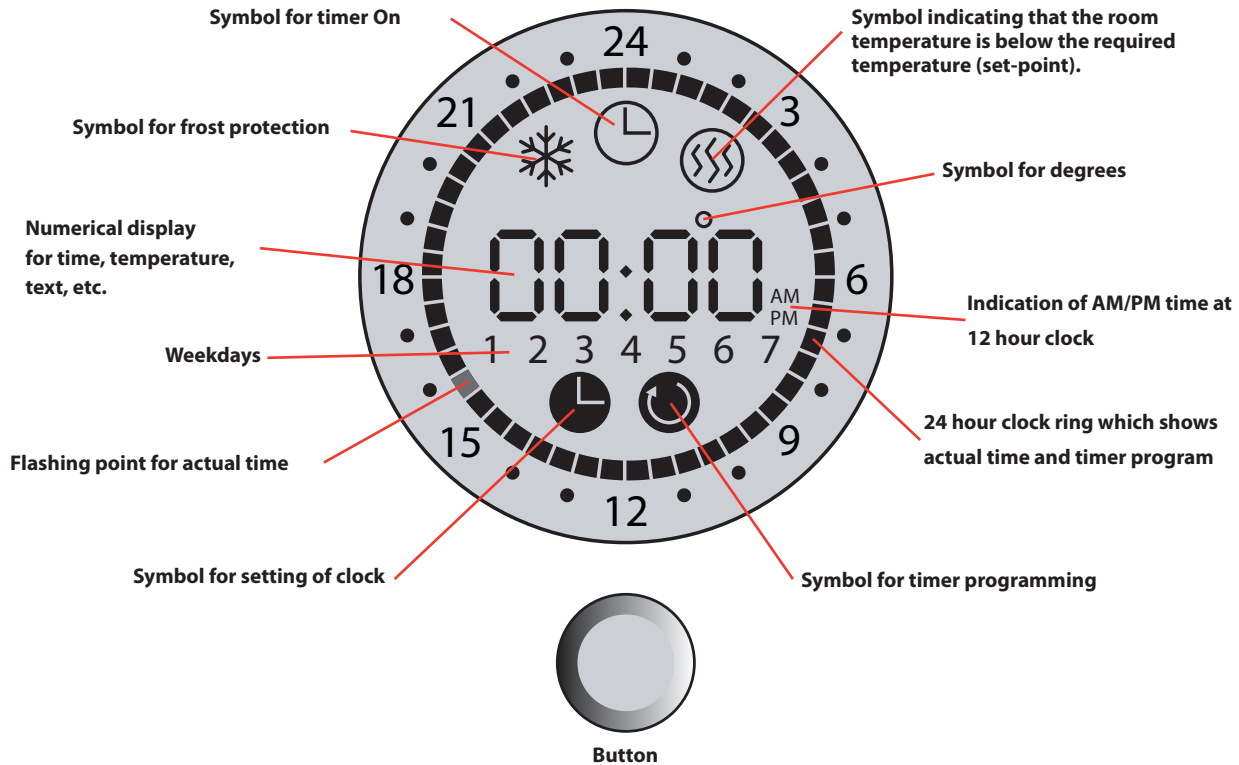

1

## Thermostat button

You can use the button on the thermostat in three different ways:

- You can turn it.

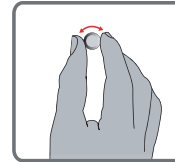

2

- You can press it.

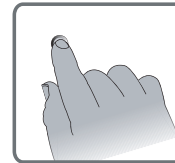

- You can press and hold it for a certain number of seconds.

3





4

## Switch thermostat on/off

Before you can switch the thermostat off, the timer function (indicated by timer symbol on the thermostat display) must be deactivated. Press the button to switch the timer function off.

To switch the thermostat **off**, turn the button anticlockwise  to lower the temperature below +5°C (1 by scale). OFF will then be shown on the display.

To switch the thermostat **on** again, raise the temperature above +5°C (1 by scale). This is done by turning the button clockwise .

 If the Devireg™ 550 only uses a floor sensor, the display will not show the wanted temperature (5° to 35°), but a scale from 1 to 10 (in steps of about 5°).

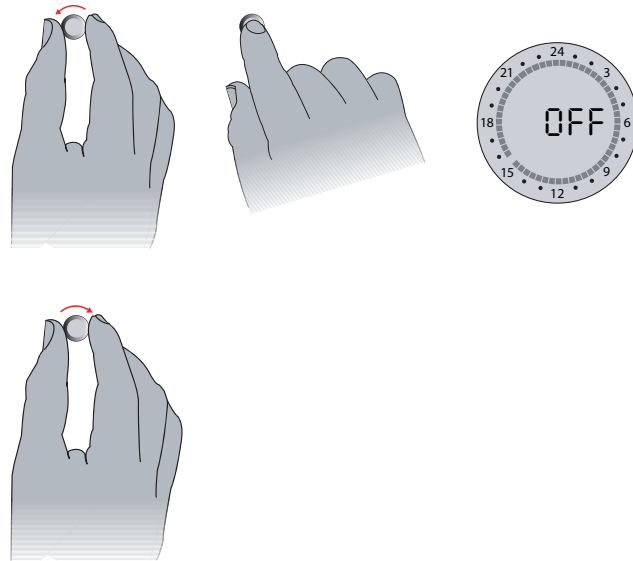



1

## Switch timer function on/off

The timer function is used for automatic switching between periods with normal (comfort) temperature and periods with lowering of temperature (e.g. at night). When switched on, a timer symbol (clock) is shown at the top of display.

- To switch the timer function **off**, press button.
- To switch the timer function **on**, press button again.

2

3

Read more about how to set periods with lowering of temperature (e.g. at night) on page 12.

4

## Clock ring

The markings on the clock ring indicates periods with normal desired temperature and periods with lowering of the temperature (e.g. at night). The flashing point indicates the actual time of day (every half hour).

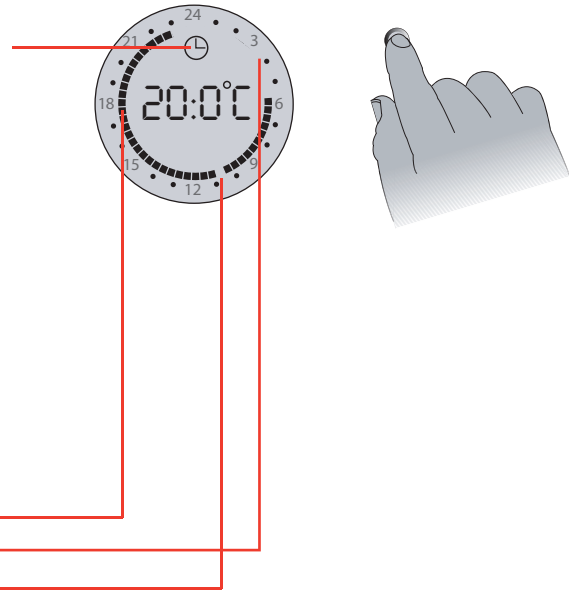

### **Network set-up with a controlling master thermostat**

⚠ If more Devireg 550™ thermostats have been installed in the house, the electrician may have chosen to link them together in a network with one thermostat serving as master unit controlling various settings on the other thermostats in the network (also called slaves). In that case the following settings are controlled by the thermostat that has been configured as master:

- Time
- Weekday
- Timer program

If the thermostats are linked in a network, any changes of time, weekday and/or periods with lowering of temperature must be made on the thermostat configured as master. The changes will then take effect on all slave thermostats.

Please contact the electrician to find out if the thermostats in the house are linked in a network, and in case they are, which thermostat has been configured as Master.

## Set weekday and clock

1

### Set weekday

- 1 Hold the button for 3 seconds.  
Then the symbol for setting of the clock and the number of the weekday will be shown on the display.
- 2 Turn the button to the right or left, until the time passes 0:00. Every time the time passes 0:00, the weekday number will go 1 up/down depending on which way you turn the button. The number you choose will be the weekday of the current day of the week. The numbers 1-7 do not correspond to any specific days, so you can choose which day of the week should be number 1, etc.  
Example: If today is Tuesday and you select 2 on the display, Tuesday will be weekday number 2.
- 3 Set the clock correctly by turning the button to the right or left.
- 4 Press the button to save the settings.

2

3

4

1 3 sec.

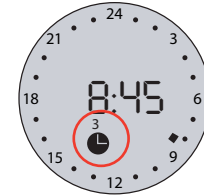
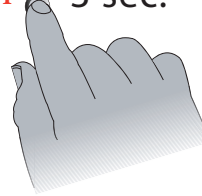

2

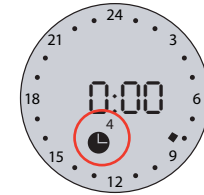
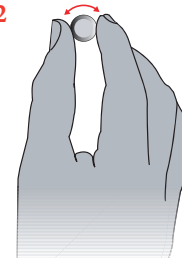

3

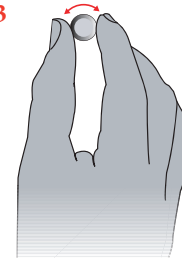

4

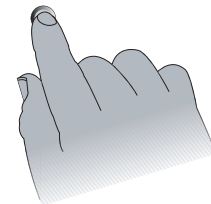

## Set the clock

⚠ The clock is not factory set.

- 1 Hold the button for 3 seconds. Then the symbol for setting of clock will be shown on the display.
- 2 Set the clock by turning the button to the right or left.
- 3 Press the button once and release to save the setting

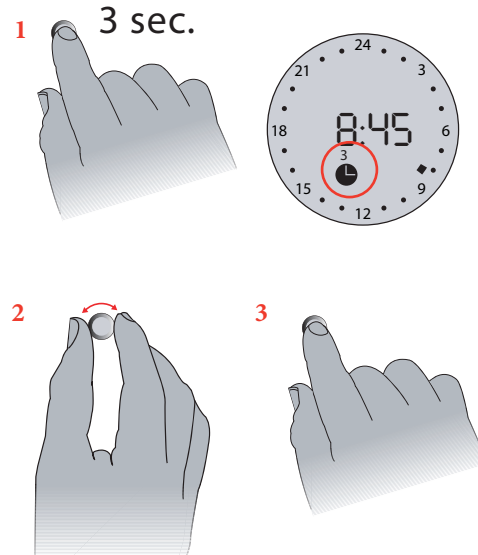

## Set temperature

1

### Constant temperature

By switching off the timer function you can set the thermostat so it will maintain a constant temperature (see how to switch timer on/off on page 6). The setting with constant temperature can be used when 24 hour heating is required or for constantly lowering the temperature when going on holiday. An unbroken clock ring indicates constant temperature.



2

3

### Fixed periods with lowering of temperature

By using of the built-in timer you can set up fixed periods for each day of the week where the temperature is lowered (e.g. at night and when you are at work). This means automatic switching between economy and comfort temperature.

4

Read more about how to set periods with lowering of temperature on page 12.

When the timer is on, it is indicated by a timer symbol in the form of a clock (and a clock ring if periods with lowering of temperature have been selected).



⚠ The display shows required temperature. In periods with lowering of temperature, however, the temperature will be lowered according to the set-back level (e.g. 5°C) that has been defined in connection with installation of the thermostat.

### Switch timer function on/off

To switch the timer function on/off, press the button. A timer symbol on the display indicates that the timer function is on.

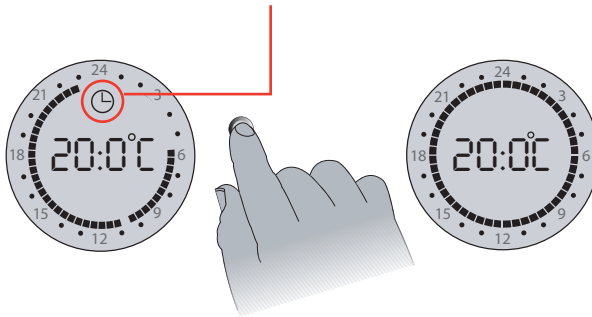

### Bathroom and en-suite applications

With all bathroom and ensuite applications, the thermostat will be located outside the room. Because the thermostat is not located in the room it is controlling, it will measure the floor temperature via a floor sensor only, therefore

the display shows temperature on a scale of 1-10 rather than degrees C. Recommended settings in this situation are 5-6, which is 25-30 degrees C.

### Raise temperature

Turn the button clockwise  to raise the temperature.

### Lower temperature

Turn the button anticlockwise  to lower the temperature.

### Frost protection

To obtain frost protection, lower the temperature to a minimum of +5°C. Then a frost symbol will appear on the display.

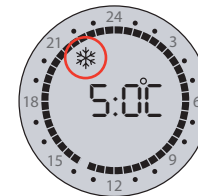

## Set periods with lowering of temperature (timer)

1

ⓘ The timer is not factory set.

- 1 Hold the button for 6 seconds.  
Then the symbol for timer programming and the weekday numbers are shown.
- 2 Select the weekday that you want to begin with by turning the button until the wanted weekday is shown. You can read more about setting weekday on page 8.
- 3 Press the button once to choose weekday.  
Now you are ready to begin defining periods.

2

3

4

1 6 sec.

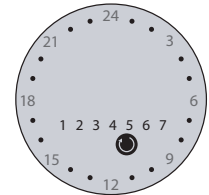
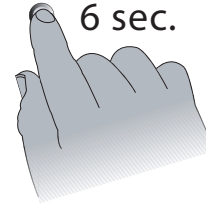

2

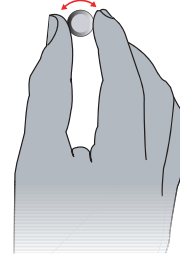

3

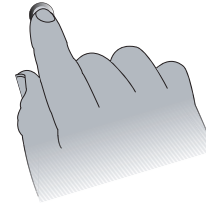

4 Turn the button clockwise to indicate the first time that normal temperatures are required (comfort), e.g. 06:00. The clock uses 30-minute intervals.

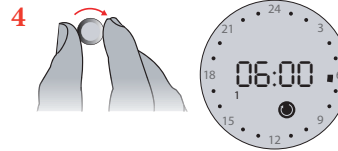

5 Press the button.

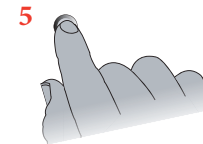

6 Turn the button clockwise to indicate the time when the temperature should be lowered again. Black segments should then be displayed, to indicate the desired settings.

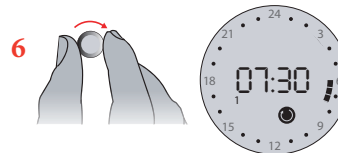

⚠ The number of degrees e.g.  $-5^{\circ}\text{C}$ , is the temperature the thermostat is lowered according to, during an economy period. This will have already been set during configuration.

7 Press the button.

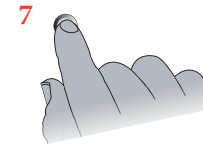

8 Turn clockwise to the period when normal temperature is required again, e.g. 15:30. Clear segments should now be displayed to indicate the economy period set.

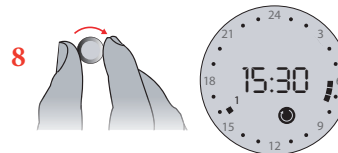

9 Press the button.

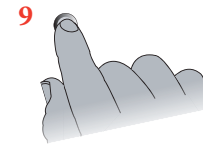



1

**10** Turn clockwise once again to the next time that you require a period with lowering temperature to begin., e.g. 22:30.

**11** Press the button.

**12** Turn forward to make settings for the following weekday, and continue until you have made period settings for all seven weekdays.

**!** Every time the clock passes midnight (00.00), it changes over to the next weekday.

**13** Finally, hold the button for 3 seconds to save your settings and finish. The display will automatically return to normal display.

**!** With Devireg™ 550 you only have to programme the time when you want comfort temperature and the time you want economy temperature. The thermostat will do the rest. You do not have to calculate when the heating should start; Devireg™ 550 will do this for you.

Please note: If at any point a mistake is made, rotate the dial anticlockwise to the first segment and press the button to clear the markers.

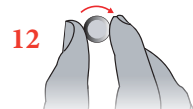
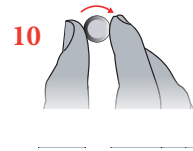

## Error messages

Devireg™ 550 has a built-in system that constantly checks the heating system, the thermostat itself and a possible network for any malfunctions. If an error occurs, the display will flash together with a code for the detected fault, which will be shown as a number from 1 to 7.

 A fault on the floor sensor/sensor cable or thermostat overheating will result in the heating being switched off.

No	Error	What to do?
2	Configured as Master, but another Master unit detected.	Call an electrician (Only one unit may be configured as a Master).
3	Configured as a Slave, but cannot find any Master unit.	Call an electrician (One unit must be configured as Master).
4	The thermostat is switched off because of overheating.	Call an electrician (Let the thermostat cool for a period. Then enter basic set-up to leave error mode).
5	Sensor fault. Floor sensor short-circuit.	Call an electrician (Floor sensor must be changed).
6	Sensor fault. Floor sensor open circuit.	Call an electrician (Floor sensor must be changed).
7	Clock is not set.	Set the clock.

## *Your notes*

---

Weekday 1 has been set to:	
The temperature will be lowered the following number of degrees at night:	
The thermostats in the house are linked together in a network with one thermostat serving as master (Yes/No):	
If the thermostats have been set up in a network, the following thermostat has been defined as master thermostat:	

# The DEVI Guarantee

You have purchased Devireg 550™, which forms an integrated part of a DEVI™ system, which we are certain will improve your home comfort and economy. A DEVI™ system provides complete heating solutions with Deviflex™ heating cables or devimat™ heating mats, Devireg™ thermostats and devifast™ fitting bands.

If, however, contrary to all expectations, a problem should occur with your Devireg™ heating system, we at DEVI™, with manufacturing units in Denmark, are, as European Union suppliers, subject to general product liability rules, as stated in Directive 85/374/CEE, and all relevant national laws which implies that:

DEVI™ provides a guarantee for deviflex™ heating cables and devimat™ heating mats for a 10 year period and all other DEVI™ products for a 2 year period against defects in material and production. The guarantee is granted on the condition that the Guarantee Certificate on the overleaf is filled out properly in accordance to instructions and that the defect is inspected by, or presented to, DEVI™ or authorised DEVI™ distributor.

Please note that the wording of the Guarantee Certificate must be provided in English or local language with the ISO code for your country in the upper left corner of the front page of the installation instructions in order to release the guarantee.

The obligation of DEVI™ will be to repair or supply a new unit, free of charge to the customer, without secondary charges linked to repairing the unit. In case of defective devireg™ thermostats, DEVI™ reserves the right to repair the unit free of charge and without unreasonable delay to the customer.

The DEVI Guarantee only covers connections made by authorised electricians and installations performed in accordance with the installation instruction and does not cover faults caused by incorrect designs supplied by others, incorrect installation or any subsequent damage that may occur. If DEVI™ is required to inspect or repair any defects caused by any of the above, then all work will be fully chargeable.

The DEVI™ guarantee is void, if payment of the equipment is in default. At all times, we at DEVI™ will respond honestly, efficiently and promptly to all queries and reasonable requests from our customers. The above mentioned guarantee concerns product liability whereas matters in relation to legislation on sale of goods shall be referred to national law.

# Guarantee Certificate

Name: \_\_\_\_\_

Address: \_\_\_\_\_

Postal code: \_\_\_\_\_

Phone: \_\_\_\_\_

## Please note:

In order to obtain the DEVI Guarantee, the following must be carefully filled in!

<< See other conditions to the left.

Electrical installation by: \_\_\_\_\_

Installation date: \_\_\_\_\_

Type of thermostat: \_\_\_\_\_

Production code: \_\_\_\_\_

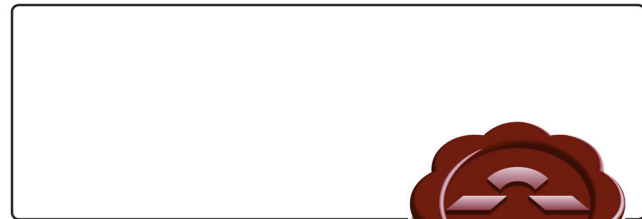

## DEVI A/S

Boedkervej 8

DK-7100 Vejle

Phone: +45 75 85 85 85

Fax: +45 75 85 71 10

[www.devi.com](http://www.devi.com)

