

MICRO RAIN

INSTRUCTION MANUAL FOR OPERATION AND MAINTENANCE

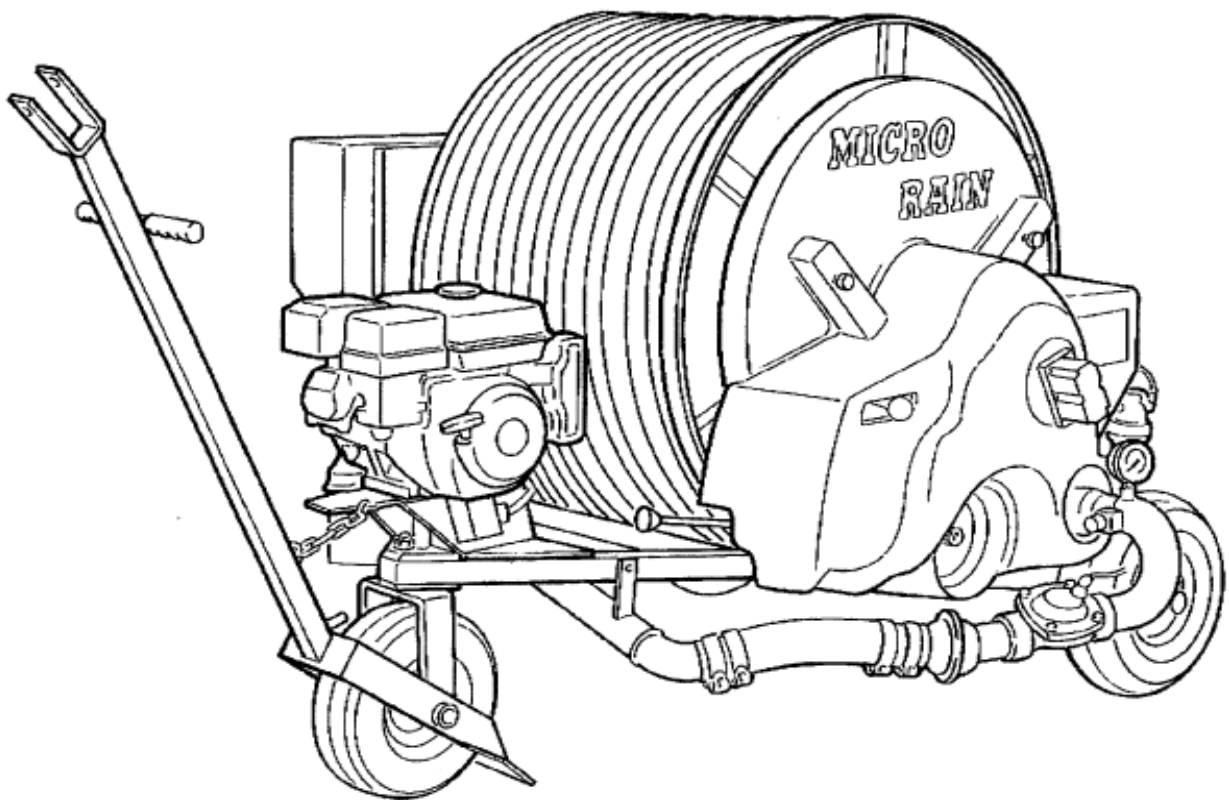

MR40, MR43

INTRODUCTION

Thank you for buying a Micro Rain traveling sprinkler. Please read this manual carefully before assembling and operation in order to become familiar with it's many functions. Your safety is our first priority, and **failure to follow these instructions may cause serious injury or death.** Micro Rain is not responsible for machine failure if these procedures and operation instructions are not followed.



CAUTION

- Do not operate your Micro Rain traveler without a serious overview of this manual
- Keep children and unauthorized people away from traveler
- Never allow children access to use the traveler



- Use caution when disconnecting couplings

When the traveler is equipped with shut-off valve, the supply hose remains pressurized at the end of the run. First, relieve the pressure, then disconnect the supply hose.

- Use caution with the sprinkler heads (Guns)

Pressurized water from the sprinkler head could cause serious damage to people or objects.

- Use caution during transport

Travelers are not made for public transit. Do not exceed 7mph on flat roads, or 2 mph on steep inclines.

- Never service the traveler when it is in operation

Before servicing, stop the traveler and disconnect the supply line. All safety guards and shields must be in place while operating the traveler.

- Beware of power lines

Irrigation water should never contact power lines or any other power source. Never let any part of the traveler or any irrigation pipe get in contact with power source.

TABLE OF CONTENTS

Signs and their meaning.....	3 - 4
Identification data.....	5
Machine Controls.....	6
Weight and Dimensions.....	7
Transport and Assembly.....	8 - 9
Start-Up Maintenance Procedures.....	10 - 12
Standard Hose Rewind.....	13
Quick Hose Rewind/Maintenance/Winterization.....	14
Care and Repair of P.E. Tube.....	15 - 16
Troubleshooting.....	17
Warnings.....	18
Use of Shut-Off Valves.....	19
Booster Pump.....	20 - 25
Performance Charts.....	26 - 27

SIGNS PRESENT ON THE MACHINE AND THEIR MEANING



1. This sign indicates the operations and parts that may be risky for the safety of the operator. When seeing this sign read carefully the message which follows, and beware of possible risk of accident.



2. This sign indicates pressurized supply lines. Do not release the clamps before making sure that the pressure is released.



3. This sign indicates dangerous equipment in operation. Never use this machine with safety guards removed. When using a PTO to rewind the hose, use only protected shafts, conforming with the safety standards in force.



4. This sign indicates a risk of electric power danger. Never position the sprinkler cart close to power supplies. Make sure that the sprinkled water does not contact any power lines, houses, roads or any working sites.



5. Before operating the machine, read the instruction manual carefully.



6. Before servicing or making any adjustments stop the machine and disconnect the supply line.

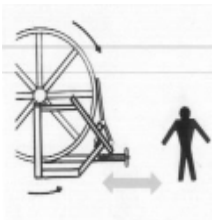

7. Do not stand between the hose reel and gun cart while machine is in operation.

SPECIAL LABELS ON SPRINKLER CART

CAUTION!

**TURN OFF WATER SOURCE AND
POINT SPRINKLER AWAY BEFORE
OPENING VALVE**

VALVE CAUTION

WARNING!

**GEARBOX MUST BE
PLACED IN NEUTRAL
BEFORE PULLING CART OUT**

GEARBOX WARNING

CONDITIONS FOR MACHINE OPERATION

- * The Micro Rain machine is designed to be used with clean water suitable for irrigation. This machine is not designed for dirty water or slurry/waste water conditions.

IDENTIFICATION DATA

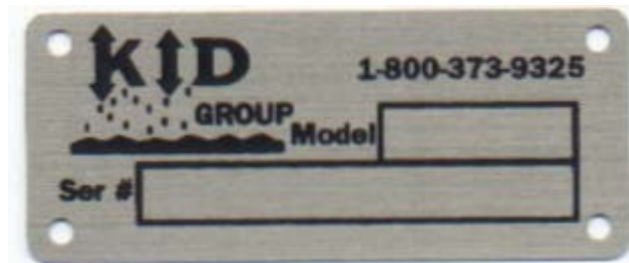

The KID ID Plate includes a model number ie. MR-43, MR 58BP, and a serial number. The ID plate is located on the left side of the machine (cover side) on the frame plate just above the rear tire.

MACHINE CONTROLS



1. Gearbox engage and disengage handle

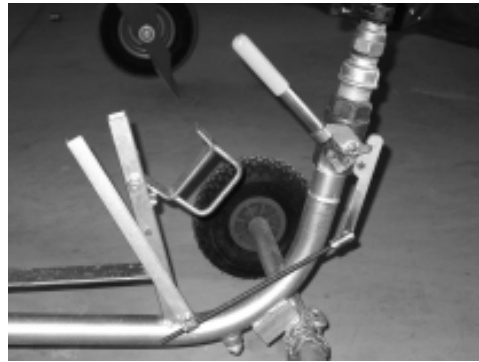

4. Shut-off valve

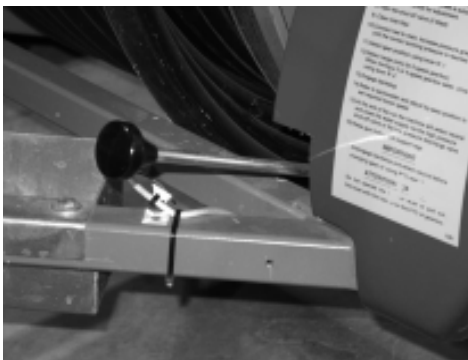

2. Anti-reverse handle



5. Speed is regulated by adjusting the by-pass



3. Automatic disengage bar



6. Electric motor regulates by-pass when using the optional GOLDEN RAIN computer

WEIGHT AND DIMENSIONS

Note: For unloading and assembly operations of the machine, use lift winches and equipment with dimensions and capacities proportioned to the weight of the machine to be lifted. (see tables)

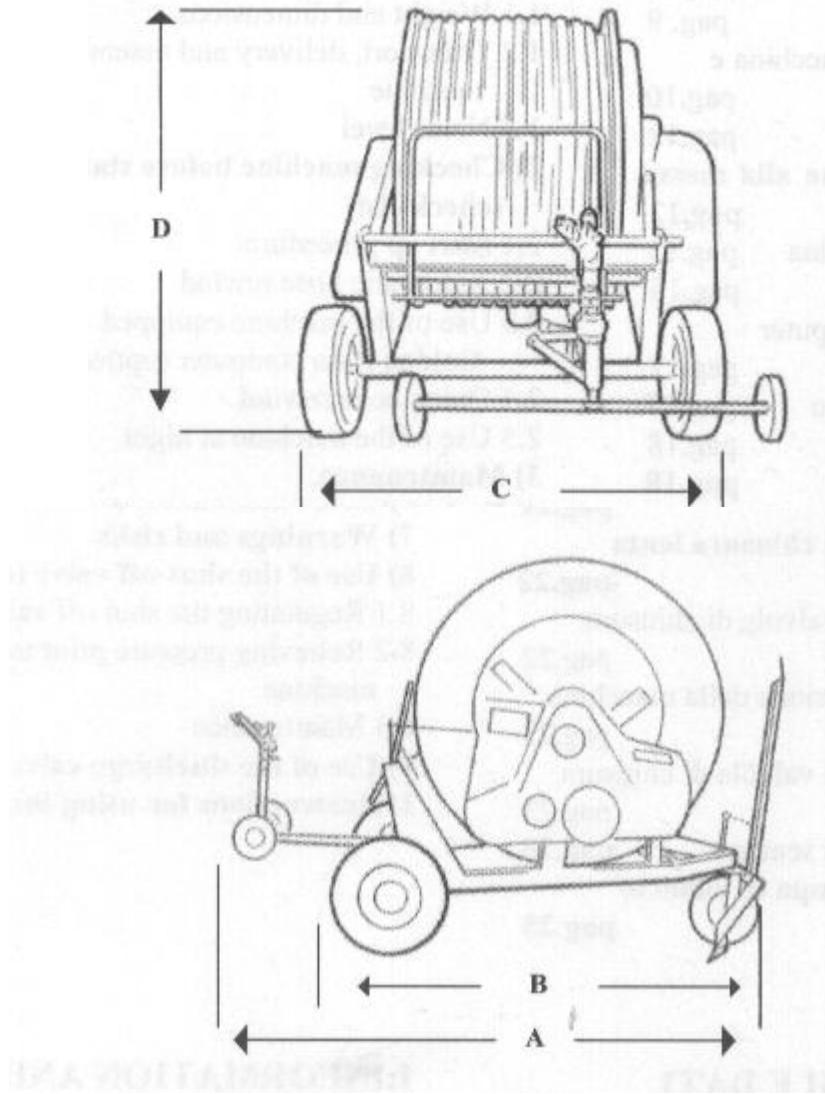

DIMENSIONS (INCHES)

	A	B	C	D
MR 40	76	59	50	50
MR 43	76	59	50	50

WEIGHT (LBS)

	DRY	WITH WATER
MR40	538	783
MR43	559	806

TRANSPORT AND DELIVERY

Due to freight height and space limitations, some assembly may be required with your newly purchased Micro Rain traveler. Be sure to follow proper procedures when unloading and assembling the machine to avoid any danger or injury.

ATTENTION!!!

NEITHER MICRO RAIN NOR MICRO RAIN DEALERS ARE RESPONSIBLE FOR ANY INJURY OR MACHINE FAILURE DUE TO LACK OF PROPER SAFETY PROCEDURES OR FAILURE TO READ AND FOLLOW INSTRUCTIONS.

- 1) Micro Rain travelers are either shipped on a special skid (partially disassembled) which can be unloaded with a fork lift, or they are shipped in a fully assembled state by blocking on the shipping floor.
- 2) The proper procedure to unload the skid shipment is with a fork lift or equivalent.



Standard packaging and pallet shipping for Micro Rain travelers.

ASSEMBLY

ATTENTION!!!

**NEITHER MICRO RAIN NOR MICRO RAIN DEALERS
ARE RESPONSIBLE FOR ANY INJURY OR MACHINE
FAILURE DUE TO CARELESSNESS OR FAILURE TO
READ AND FOLLOW INSTRUCTIONS!!!**

1. Assemble the Gun Cart (fig 1).
 - a. Push the end of the P.E. hose onto the guncart as indicated in fig 3. Applying heat to the end of the P.E. hose will ease this process.
 - b. Tighten the clamp provided, with the bolts on top.
 - c. Mount the sprinkler gun onto the gun cart. Use teflon tape or a thread compound to provide a proper seal.
 - d. Using the hand grip, pick up the gun cart and hook it onto machine (fig 2).

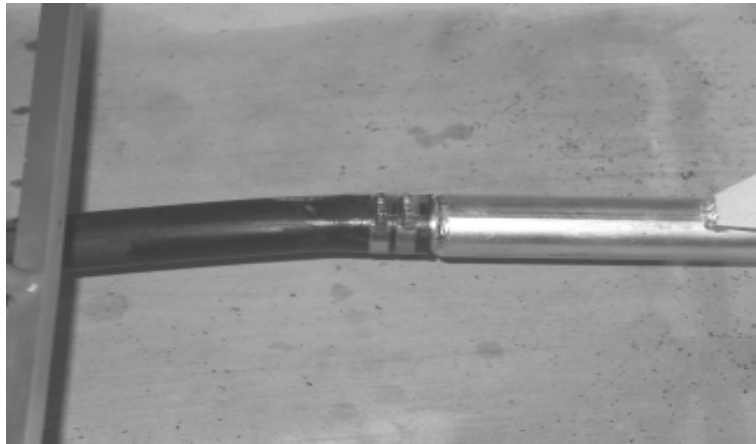

FIG 1

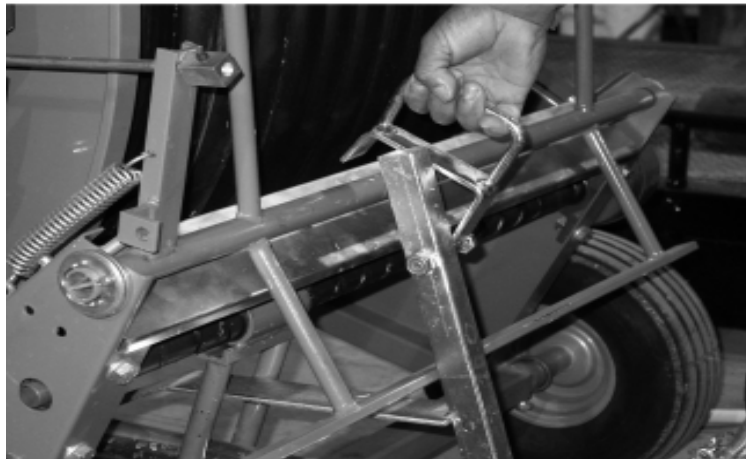

FIG 2

CHECKING MACHINE BEFORE START UP (CHECK-LIST)

1. Check the oil level of the gearbox and if necessary add SAE 80W/90. Keep oil level at the side plugs in the gearbox in order to bathe the shift fork in oil.
2. Grease the machine thoroughly (all grease fittings) and thereafter, grease every 100 hours.
(see fig 1). Pay close attention to the two grease fittings on the drum inlet. One grease fitting is located on the bottom side and lubricates the drum inlet seals. Grease must be spread on the drum gear teeth and at the drive shaft where the drum gear and drive gear mesh. The scroll bar must also be kept well greased, and the scroll knife must be lubricated (grease fitting) in order to function correctly.
3. Check the tire pressure and if necessary, inflate to pressure recommended on the tire (generally 35psi).

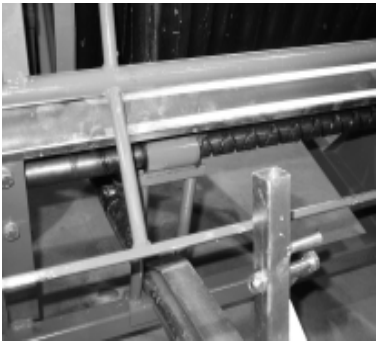
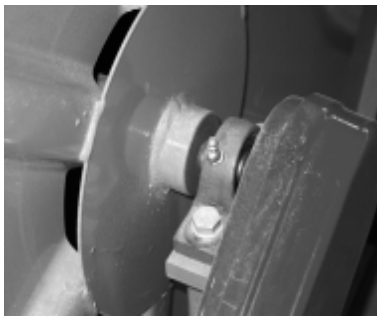
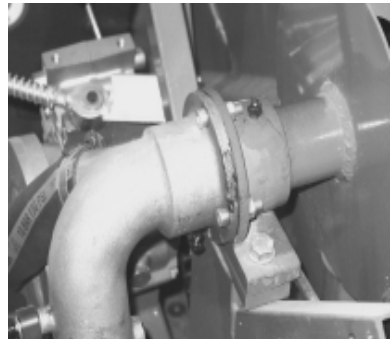
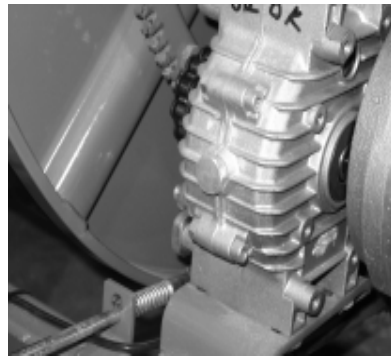

FIG 1



LUBRICANT TABLE

Gearbox	SAE 80W/90
Reel Supports	Grease NLGI No.2
Grease Fittings	Grease NLGI No.2



START UP PROCEDURE

1. Tow the machine to the working site (off-road only). Maximum speed is 7 MPH. **WARNING!!** Before towing machine, be sure no one is standing behind or around the machine, and the gun cart is racked.
2. Face the gun cart side of the reel towards the area needing to be irrigated. The machine direction should be as straight as possible.



FIG 1

3. Set the stabilizer (fig 1).
4. Lower the gun cart.
5. Connect the water supply hose to the water inlet connection on the machine (fig 2).
NOTE: Before connecting the supply hose to the machine, flush out hose or check to be sure there is no foreign matter which will block the turbine.



FIG 2

6. Release the backstop (anti-reverse) lever. (fig 3). Pull straight back and down to release.
7. **Important!** Make sure the gearbox lever is in the disengaged or idle position before unwinding tube (fig 4).

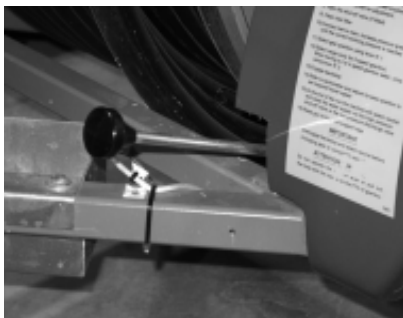

FIG 3



FIG 4

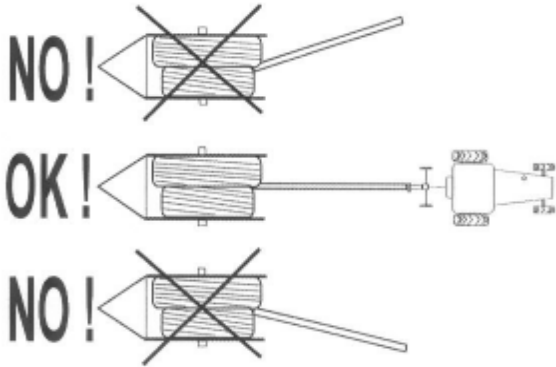

FIG 5



FIG 6

8. Pull the gun cart out straight (fig 5), and at a consistent speed (about the pace of a walk), and slow down when approaching the stop or end position. **NOTE:** Always leave at least one wrap of hose on the reel.
9. Pull up on shut off valve handle to place into operational position (open valve). This procedure must be completed with the water source off and the sprinkler pointed away from any individuals.(fig 6)
10. Re-engage the anti-reverse handle (fig 3) and start water flow. Turn speed control valve to the fast setting (full counter-clockwise) (fig 7) and engage gearbox. Turn speed control in the clockwise direction to slow reel to the desired speed. If computer speed control system, see **page 13** for specific instructions on operation.
11. When you have pulled out the hose, **make sure that the wraps remaining on the reel are tight and close together next to the edge of the drum. If necessary, roll the drum by hand to tighten wraps, and push them in place by hand. (fig 8).** This adjustment must be done when machine is not in operation.

IMPORTANT! The first time using the machine it is very important to pull out all but 1 or 2 wraps of hose in order to check the level wind setting, and remove any loose wraps that may have been created in shipping. If level wind setting needs adjusting, contact your Micro Rain dealer for instructions.



FIG 7

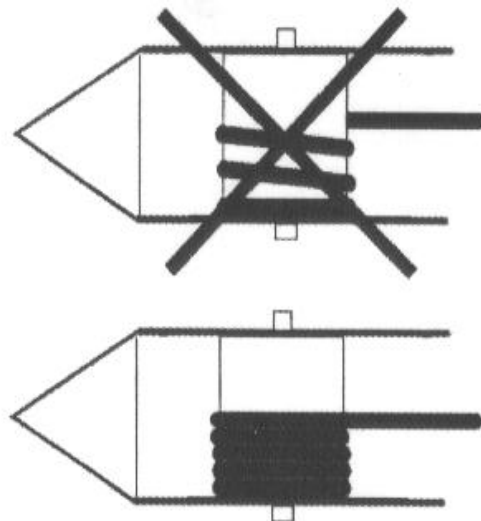

FIG 8

STANDARD HOSE REWIND

(Ready to rewind for irrigation)

1. Release the back stop (anti-reverse) (fig 1) into the operating position by gently lifting handle until it releases from the locked position.

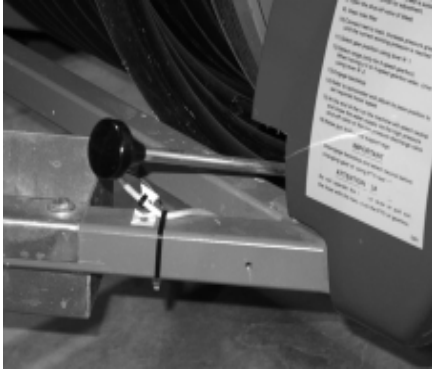

FIG 1



FIG 2

2. Turn the water supply on and increase the machine pressure until it reaches the desired operating pressure.
3. Engage the gearbox with the gearbox handle (fig 2), to put the reel into rewind motion.
IMPORTANT!!! Never force this lever into gear. Forcing into gear will irrevocably damage the gearbox and void the warranty. Lever should be pushed gently into gear, allowing the gears to mesh. **This process is best completed with water running through the turbine.**
4. Adjust hose retraction speed. On a **manual speed control** machine, this is completed by adjusting the position of the bypass valve (fig 3). Full reel speed is achieved with the valve turned full counter-clockwise. To slow the retraction speed, slowly turn the bypass valve clockwise until the desired retraction speed is obtained. On **computer speed control** machines, speed is adjusted by entering the desired retraction rate (in ft/hour) on the computer key pad.(fig 4) The speed can be adjusted any time in operation by using the + or - buttons on the key pad. See the Golden Rain manual for specific instructions concerning the computer setting/operation.



FIG 3



FIG 4

QUICK HOSE REWIND

The purpose of the PTO shaft on the gearbox is to rewind the hose quickly by using the tractor. If for any reason you need to wind the hose up quickly then follow these steps.

1. **WARNING!** Make sure the handle on the gearbox is in the idle or disengaged position, otherwise severe damage will occur to the gearbox. Disengage the anti-reverse lever.
2. Connect the tractor PTO drive line to the gearbox shaft on the Micro Rain. **WARNING!** Read drive-line directions for proper use of the PTO drive-line. Neither Micro Rain nor Micro Rain dealers are responsible for improper use of the drive line which can result in injury or death.
3. Slowly activate the tractor power take off and the reel will begin to wind up. Roll up hose at the slowest possible RPM.



IMPORTANT!! Do not engage PTO with high RPM. This can damage the drive gear.

IMPORTANT!! When using the PTO shaft, there is no automatic stop at the end of the run. The PTO must therefore be stopped before the hose is completely wound up to avoid damage to the gun cart or the end of the hose. It is recommended the final wrap or two to be wound up manually.



IMPORTANT!! To avoid irregular rewinding of the hose when using a PTO, it may be necessary to wind the hose up under water pressure to avoid excessive ovaling of the hose.

MAINTENANCE

1. Grease all grease fittings every 100 hours of operation.
2. Grease all wheel hubs every 100 hours of operation.
3. Grease the drum gear at least twice per season.
4. Change the gearbox oil every season.
5. Check tire pressure every 4-6 weeks.

WINTERIZING

1. Remove plug or open petcock placed under the turbine (fig 1).
2. Remove drain plug on bottom of gun cart.
3. If the machine is equipped with the blue diaphragm valve (machines prior to 2002 model), the black filter body (fig 2), and blue valve must be drained (fig 3).
4. If the machine has a boost pump, then the pump volute and plumbing must be drained.
5. Machines equipped with the cart shut-off valves (2002 - present machines) must leave valve in the open position to avoid freeze damage. Note: Open and close valve several times before leaving valve open.



FIG 1



FIG 2



FIG 3

CARE OF THE POLYETHYLENE TUBE

The polyethylene tube (P. E. Tube) is a very durable and will serve your irrigation needs for many years with proper care and handling. Observe these simple precautions when using your Micro Rain traveler to prevent damaging or shortening the life of your tube.

1. The first time you unwind the tube, pull off all but a couple of wraps. This will allow you to check the level-wind position, and make sure there are no loose wraps left from shipping.
2. Always transport your machine with the anti-reverse lever engaged, and cart racked.
3. Do not attempt to operate the machine with loose or misplaced wraps of tube. Tighten the tube on the drum before starting the machine. **WARNING!!** Starting the machine without tightening the tube wraps will result in miswrapping and could permanently damage your tube.
4. Do not attempt to move or relocate the machine with tube unwound. All the tube must be wound on the machine drum before moving.
5. While the tube is unwound make certain never to drive anything across the tube.
6. Be careful when operating other equipment near the unwound tube.
7. Never sharply bend or kink the tube. It will not flex back, and it will be permanently damaged.

REPAIR COUPLER FOR P.E. TUBE

Screw-in menders are the best way to repair damaged P. E. tube in the field. These metal menders will allow you to repair damaged tube without replacing the entire length of tube. These tube menders can be obtained from your Micro Rain dealer.

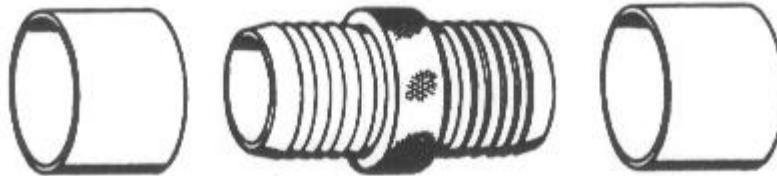

INSTALLATION

1. Cut the tube with a hack-saw on either side of the damaged area. Make sure your cuts are straight. Place expansion collar over each end of tube (fig 1).



FIG 1

2. Chamfer/bevel the inside and outside of the tube with a knife or file, so that the threads of the metal mender will enter the tube.

3. **NOTE!!** The threads on the metal mender are lefthand threads on one end and righthand threads on the other. Screw the mender in one end about 2/3 of the way using a wrench. Then unscrew it. Repeat the procedure on the other end. Remember one end is left-hand thread. Do not apply heat to the tube during this procedure (fig 2).



FIG 2

4. Complete the procedure by starting the threads in both ends at the same time, turning the mender with a wrench. Screw the mender all the way into the tube until the two ends meet and are snug (fig 3).



FIG 3

TROUBLESHOOTING

HOSE DOES NOT WIND UP

- * The impeller of the turbine is blocked by foreign matter. **Solution-** Remove the turbine cover and clean the housing.
- * The gun is partly clogged and only a small amount of water comes out. **Solution-** Proceed to clean out gun nozzle.
- * The injection nozzle in the turbine is clogged. **Solution-** Disassemble the hose at the turbine entry and clean out.
- * The gun nozzle is too small, compared to the machine . **Solution-** Replace with a larger gun nozzle or a smaller injection nozzle.
- * Not enough water volume or pressure at the machine inlet. **Solution-** Increase volume and/or pressure.
- * The gearbox has been damaged. **Solution-** Repair the gearbox.

MACHINE WON'T STAY ANCHORED OR SLIDES

- * The machine legs are improperly placed. **Solution-** Reposition leg to create more friction.
- * The hose is on damp soil or grass which produces too much drag. **Solution-** Wait until the soil has dried or pick up hose and place blocks of wood under in order to reduce friction.

RECOMMENDATIONS

- * When moving the machine never exceed the maximum speed of 7 MPH.
- * If the hose is wound up using the PTO, be certain the gearbox is in the idle or disengaged position, or the gearbox will be seriously damaged.
- * At the beginning of each season, completely unwind the hose, leaving only two wraps on the reel.
- * **ANY MODIFICATION MADE TO ANY PART OF THE MACHINE WILL VOID THE WARRANTY.**
- * If the hose remains unwound on the ground for an extended period of time (several hours), it may stick to the ground. Prior to starting the machine, take a rope and drag underneath the tube from one end to the other, avoiding any damage due to too much friction.
- * If the machine is being used on several short fields, the hose may miswrap, or not continue to roll up correctly. If this happens, unwind the hose with only two wraps remaining on the drum, allowing the machine to rewind properly.
- * **THE MACHINE MUST NOT BE OPERATED WITHOUT THE PROTECTION GUARDS**
- * **IMPORTANT!!** *Failure to observe these instructions, the use of non original spare parts, or unauthorized changes to the machine will void the warranty.*

WARNINGS AND RISKS

MICRO RAIN AND MICRO RAIN DEALERS ARE NOT RESPONSIBLE FOR ANY INJURY OR DAMAGE DONE DUE TO FAILURE TO FOLLOW SAFETY GUIDELINES

Despite Micro Rain's attempt to make a safe and secure machine, some risks still remain unavoidable in the operation of the machine. **Failure to heed these warnings can cause serious injury or death.**



When pulling out the hose no one should be standing on or around the machine unless authorized to do so.

No part of the body should ever be between the hose and the reel when the machine is in use. This applies especially to unauthorized people.

When the machine is being transported on a grade of 6 degrees or greater, there is a risk of the machine overturning. Take every precaution to avoid transporting on steep grades.

Make sure that in the rain gun (sprinkler head) path of irrigation there are no electrical wires or power lines.

Tremendous water pressure comes through the hose to the gun. Avoid standing by or near the direction of the sprinkler gun.

Never remove the quick connect couplings on the machine while water pressure is being supplied to the machine.

Be very careful when transporting the machine. Use safety measures when towing. When irrigating be sure sprinkler head is not pointing toward objects or individuals unaware of the powerful jet-stream.

USE OF THE SHUT-OFF VALVES

STANDARD CART SHUT-OFF VALVE

1. The valve handle must be pulled upward and locked into position for irrigation. The handle should only be placed into this open position (Fig 1) with the water source off and the sprinkler pointed away from all individuals. The valve could still be under pressure from a previous irrigation run. Always use caution when opening the valve.
2. When the cart approaches the machine, the shut-off bar will trip the shut-off valve and the water will stop flowing. This stops the machine. The shut-off valve handle will now be in the down position (off position). (Fig 2)
3. **Prior to re-pulling the cart out for the next irrigation run, shift the gearbox back into neutral.** The gearbox will be seriously damaged if the hose is unwound with the gearbox still engaged.



FIG 1

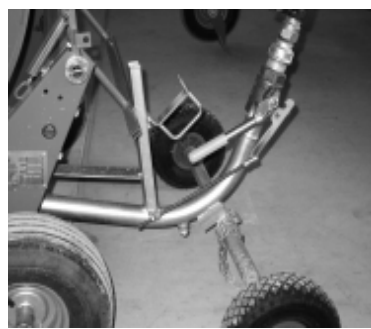

FIG 2

OPTIONAL DIAPHRAM VALVE SHUT-OFF

1. The diaphragm valve (Fig 3) is actuated by the roller switch/bullet mechanism (Fig 4). For irrigation operation, the bullet must be completely off of the roller switch (3-way valve).
2. When the cart actuates the shut-off bar, the bullet is moved over the roller switch. The plunger in the valve is pressed down by the bullet, and the valve will close and stop the water flow. Make any position adjustments to the bullet by loosening the set screw and sliding along the bar.
3. All points behind the diaphragm valve will still be under pressure. Therefore, it is recommended that the pressure be relieved prior to disconnecting any hoses.



FIG 3



FIG 4

INSTRUCTIONS FOR BOOSTER PUMP (OPTIONAL)

These instructions are to be followed after the hose and gun cart have been pulled to the desired location.



**DO NOT USE THE
PUMP WITHOUT
WATER**



Please see engine check list using the enclosed engine owners manual. Follow engine procedures as instructed by the engine manufacturer to avoid pump or machine damage. **Micro Rain or Micro Rain Dealers are not responsible nor liable for operator failure to follow engine and machine instructions and guidelines.**

* Remove the gas cap and fill the gas tank to the side of the engine with gasoline and replace the cap. Do not over-tighten gas cap. Check gas level often to be sure engine has fuel (fig 1).



FIG 1



Never use the tank placed on the engine (fig 2) for any reason.



FIG 2

1. Connect the water supply hose to the quick connect fitting (fig 3) on the machine.

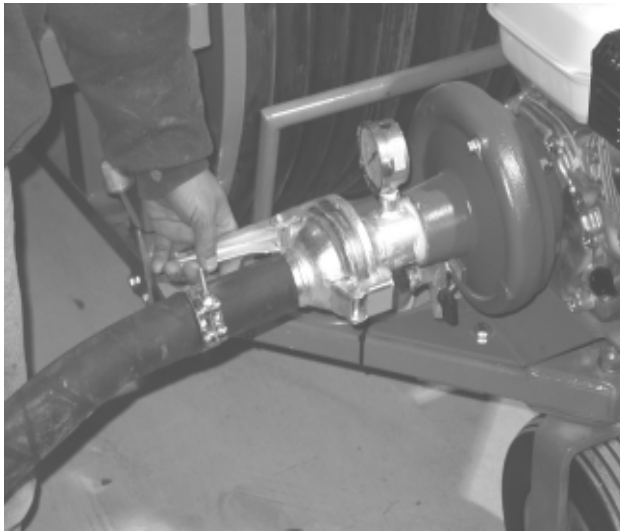

FIG 3

2. If your machine has a shut-off valve (fig 4), make sure the valve handle is in the working (up) position.



FIG 4

3. Turn on the water source and pressure to the machine.

ENGINE START-UP

NOTE: The engine will not start without water flowing through the machine!

4. Turn on the gas switch as indicated in fig 5.

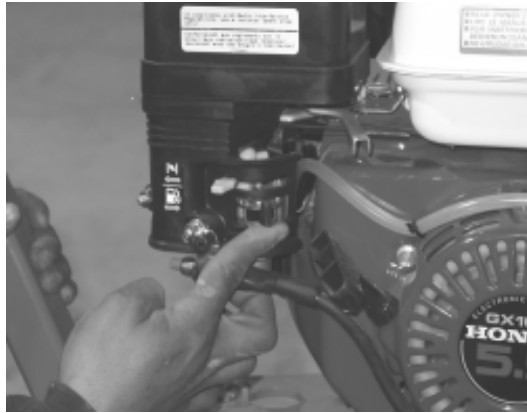

FIG 5

5. If the engine is cold, “choke” the engine by pushing the switch to the left (fig 6).

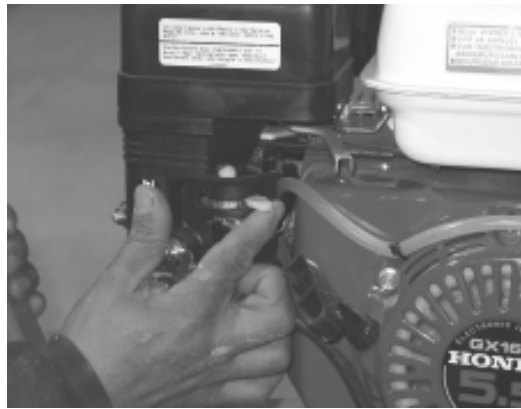

FIG 6

6. Start the engine by pulling on starter rope (Fig 7), or by turning ignition key clockwise (Fig 8)



FIG 7



FIG 8

7. Set the choke to a smooth working position by moving the lever to the right.
8. Increase engine speed until the desired working pressure is obtained.



WARNING!! Do not exceed the maximum working pressure of 120 psi, at the gauge on the cross pipe (if boost pump model).

* **STOPPING AT THE END OF RUN:** When the gun cart arrives at the machine at the end of the run, it activates the shut-off valve. When the valve is closed, the flow switch mounted on the cross pipe (fig 8) senses the loss of water flow and automatically kills the engine.

Note: Water should always be running through the pump prior to starting boost pump, but if for some reason the pump must be started without water flow (for short duration), the by-pass button can be pressed to override the flow switch. The switch is located on the engine mount frame. (Fig 9). Again, the pump must not be run for more that 5 seconds without water to lubricate the mechanical seal.



FIG 8

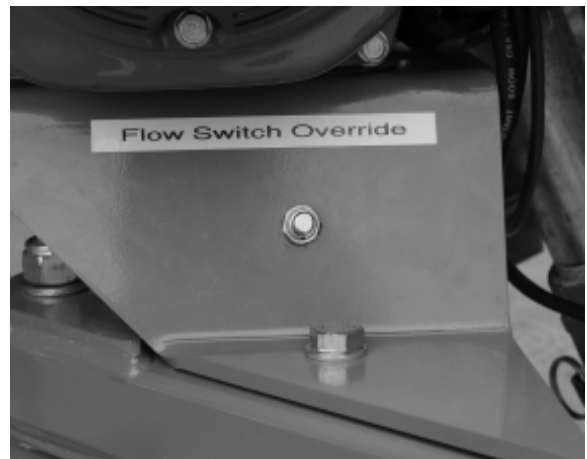

FIG 9

FORBIDDEN USES



WARNING
DO NOT USE THIS MACHINE IN
A NON-VENTILATED AREA



1. Do not use this machine with solids, waste, etc. This machine is designed only for use in clean water applications.
2. Do not use in high risk areas for explosives.
3. Do not use in enclosed areas.

OPERATION AND MAINTENANCE

1. Check oil level prior to each operation, and change oil as recommended (Refer to Honda Owners Manual).
2. Follow environmental regulations when disposing of old parts or oil.
3. Regular maintenance and repairs must be performed by a trained professional operator.
4. Any and all repairs and maintenance must be performed when the engine is turned off and cooled down.

FIRE EMERGENCY

1. In case of fire use a powder fire extinguisher.

BATTERY INSTRUCTIONS AND USE

1. The electrolyte is a diluted sulfuric acid solution. In case of contact with skin, wash immediately!! Contact medical help immediately if solution gets in your eyes. **WARNING!!** When recharging any battery, a flammable gas is produced which could cause battery to explode.
2. Avoid sparks when attaching or charging battery. Verify correct cable placement. Verify that battery cables are placed correctly when recharging the battery (+ with +, - with -). Keep away from matches, cigarettes or any flammable objects. Do not rest metal tools on the battery.
3. Keep children away from the battery! Periodically verify the battery charge. During the off season, remove the battery and keep it in a warm, dry location and recharge as necessary.

WARNINGS FOR POTENTIAL RISKS

1. **WARNING!!** Never exceed the maximum operating pressure of 120 psi. Monitor the pressure gauge on the machine inlet. Extreme high pressure may cause product failure and result in serious injury.
2. **WARNING!!** During operation of machine, stay away from parts which experience high temperature such as the muffler, manifold, etc., which may burn or cause serious injury.
3. **WARNING!!** Do not get close to moving parts nor high temperature parts to avoid danger or serious injury.

TROUBLESHOOTING ENGINE and BOOSTER PUMP

THE ENGINE DOES NOT START

* The machine does not have water pressure. The flow safety switch will not allow the engine to start with water running through the machine.

* A closed shut-off valve.

Solution- Make sure the handle is in the up position (open) for operation (Fig 1)

* Flow switch is malfunctioning.

Solution- Remove switch and check contacts and wiring. Replace if necessary. (Fig 2)



FIG 1



FIG 2

* Check oil level. If oil level is below required level, the engine will not start.

* Check to be sure fuel is getting to the engine. Open the carburetor drain to check for fuel.

PUMP IS LEAKING

* Replace the mechanical seal inside the pump.

PUMP IS NOT BUILDING PRESSURE

* Check the impeller in the pump. It could be clogged or broken.

MR40 PERFORMANCE CHART

6 mm Nozzle		80%			RUN TIME(HRS)		
INLET PSI	GPM	MAX WIDTH	ADJ WIDTH	MAX LENGTH	0.10 INCH	0.25 INCH	0.50 INCH
45	9.3	100	80	477	3.80	9.51	
55	10	110	88	482	3.89	9.72	
65	10.8	112	90	483	3.67	9.17	
75	11.9	116	93	485	3.45	8.62	17.24
85	12.8	120	96	487	3.32	8.29	16.58

7 mm Nozzle		80%			RUN TIME(HRS)		
INLET PSI	GPM	MAX WIDTH	ADJ WIDTH	MAX LENGTH	0.10 INCH	0.25 INCH	0.50 INCH
45	11.1	100	80	477	3.19	7.96	15.93
55	12.7	106	85	480	2.95	7.38	14.76
65	14	114	91	484	2.88	7.20	14.40
75	15.6	118	94	486	2.67	6.69	13.37
85	16.4	124	99	489	2.67	6.67	13.34

8 mm Nozzle		80%			RUN TIME(HRS)			
INLET PSI	GPM	MAX WIDTH	ADJ WIDTH	MAX LENGTH	0.10 INCH	0.25 INCH	0.50 INCH	0.75 INCH
55	15.3	114	91	484	2.63	6.59	13.17	
65	17.9	122	98	488	2.41	6.03	12.05	
75	19.4	127	102	491	2.31	5.79	11.57	17.36
85	21.1	134	107	494	2.25	5.61	11.23	16.84
95	22.8	139	111	497	2.16	5.39	10.78	16.17

9 mm Nozzle		80%			RUN TIME(HRS)			
INLET PSI	GPM	MAX WIDTH	ADJ WIDTH	MAX LENGTH	0.10 INCH	0.25 INCH	0.50 INCH	0.75 INCH
55	19	112	90	483	2.08	5.21	10.42	15.63
65	21.5	118	94	486	1.94	4.85	9.70	14.56
75	23	128	102	491	1.97	4.92	9.84	14.76
85	24.8	134	107	494	1.91	4.78	9.55	14.33
95	26.8	139	111	497	1.83	4.59	9.17	13.76

10 mm Nozzle		80%			RUN TIME(HRS)			
INLET PSI	GPM	MAX WIDTH	ADJ WIDTH	MAX LENGTH	0.25 INCH	0.50 INCH	0.75 INCH	1.00 INCH
55	22.8	115	92	485	4.46	8.92	13.38	17.84
65	24	121	97	488	4.46	8.91	13.37	17.83
75	26.9	126	101	490	4.14	8.28	12.42	16.56
85	29.4	135	108	495	4.06	8.12	12.18	16.24
95	31.2	142	114	498	4.02	8.05	12.07	16.09
105	32.5	146	117	500	3.97	7.94	11.91	15.89

NOTICE: These specifications are for a guide only and are based on theoretical calculations and performance tests. This is to be used as a guide only, as performance may vary under field conditions.

MR43 PERFORMANCE CHART

6 mm Nozzle		80%			RUN TIME(HRS)		
INLET PSI	GPM	MAX WIDTH	ADJ WIDTH	MAX LENGTH	0.10 INCH	0.25 INCH	0.50 INCH
45	9.4	100	80	443	3.46	8.66	
55	10.3	108	86	447	3.41	8.53	
65	11.1	113	90	450	3.31	8.28	
75	11.9	116	93	451	3.17	7.93	15.86
85	12.9	120	96	453	3.03	7.57	15.14

7 mm Nozzle		80%			RUN TIME(HRS)		
INLET PSI	GPM	MAX WIDTH	ADJ WIDTH	MAX LENGTH	0.10 INCH	0.25 INCH	0.50 INCH
45	11.6	102	82	444	2.86	7.15	14.31
55	13.1	109	87	448	2.71	6.77	13.54
65	14.4	116	93	451	2.62	6.55	13.11
75	15.9	122	98	454	2.50	6.24	12.49
85	17.3	127	102	457	2.39	5.97	11.95

8 mm Nozzle		80%			RUN TIME(HRS)			
INLET PSI	GPM	MAX WIDTH	ADJ WIDTH	MAX LENGTH	0.10 INCH	0.25 INCH	0.50 INCH	0.75 INCH
55	17	118	94	452	2.26	5.65	11.30	
65	18.9	128	102	457	2.20	5.51	11.02	
75	20.7	132	106	459	2.08	5.19	10.38	
85	22	139	111	463	2.06	5.14	10.28	15.42
95	24.7	144	115	465	2.06	4.74	9.49	14.23

9 mm Nozzle		80%			RUN TIME(HRS)			
INLET PSI	GPM	MAX WIDTH	ADJ WIDTH	MAX LENGTH	0.10 INCH	0.25 INCH	0.50 INCH	0.75 INCH
55	21.3	120	96	453	1.83	4.58	9.17	13.75
65	23	128	102	457	1.81	4.53	9.06	13.58
75	24.2	134	107	460	1.80	4.51	9.01	13.52
85	26.5	139	111	463	1.71	4.27	8.54	12.80
95	28.7	146	117	466	1.80	4.14	8.28	12.42

10 mm Nozzle		80%			RUN TIME(HRS)			
INLET PSI	GPM	MAX WIDTH	ADJ WIDTH	MAX LENGTH	0.25 INCH	0.50 INCH	0.75 INCH	1.00 INCH
55	24.3	120	96	453	4.02	8.04	12.05	16.07
65	26	130	104	458	4.07	8.14	12.20	16.27
75	29.7	140	112	463	3.84	7.67	11.51	15.34
85	32.3	144	115	465	3.63	7.25	10.88	14.51
95	34.5	148	118	467	3.49	6.98	10.47	13.96
105	36.5	150	120	468	3.34	6.69	10.03	13.38
115	37.6	153	122	470	3.31	6.62	9.93	13.24

12 mm Nozzle - HIDRA		80%			RUN TIME(HRS)			
INLET PSI	GPM	MAX WIDTH	ADJ WIDTH	MAX LENGTH	0.25 INCH	0.50 INCH	0.75 INCH	1.00 INCH
55	35.2	120	96	453	2.77	5.55	8.32	11.10
65	39.8	130	104	458	2.66	5.32	7.97	10.63
75	42.7	140	112	463	2.67	5.34	8.00	10.67
85	45.2	150	120	468	2.70	5.40	8.10	10.80
95	49.1	160	128	473	2.65	5.30	7.95	10.61
105	52.1	167	134	477	2.61	5.22	7.82	10.43
115	53.1	172	138	479	2.64	5.27	7.91	10.54
125	55	178	142	482	2.63	5.27	7.90	10.53

NOTICE: These specifications are for a guide only and are based on theoretical calculations and performance tests. This is to be used as a guide only, as performance may vary under field conditions.

KID Group, Inc.
DISTRIBUTOR, DEALER/SELLER, PURCHASER AGREEMENT

LIMITED WARRANTY AND REMEDY:

WARRANTY

KID Group, Inc. as distributor, warrants to the original purchaser only of the Micro Rain Irrigation Equipment described in the face hereof as of the date of the original invoice, that the equipment is merchantable and free from defects in material and workmanship.

This warranty does not apply to certain component parts used on Micro Rain equipment. Warranty shall be provided by the original manufacturer of these components. Such components include, but are not limited to tires and tubes, boost pump motors, and batteries.

REMEDY

If KID Group, Inc. determines that the above warranty was breached with respect to any part or component provided by the manufacturer (Ocmis Irrigation) of Micro Rain equipment, (and if all conditions set forth below have been satisfied) then, KID Group, Inc. will (at KID Group, Inc.'s option) repair or provide purchaser replacement parts F.O.B. Yukon, OK. As follows:

1. All components of new Micro Rain system for 1 year from original equipment invoice, free of charge.
2. KID Group, Inc. will repair or provide replacement polyethylene tube for any tube KID Group, Inc. determines has failed, due to defects in workmanship or materials for 3 years from the date of original invoice, free of charge.

All remedies provided herein are for parts only, no labor or freight allowance for return parts is implied.

This warranty extends only to the original purchaser of Micro Rain equipment purchased from an authorized Micro Rain dealership.

CONDITIONS TO ENFORCEABILITY AND CLAIMS:

1. Equipment has been maintained and operated within the guidelines outlined in Micro Rain owner's operation and maintenance manual.
2. Equipment warranty shall be considered void if any component or function of the equipment has been altered in any form other than what has been provided or intended by the original equipment manufacturer (Ocmis Irrigation).
3. Any claim must be submitted on form provided by KID Group, Inc. in writing immediately and in no event longer than 20 days from occurrence.
4. Purchaser/Dealer must return all parts within 30 days of KID Group, Inc.'s authorization date, that have been determined by KID Group, Inc. to be defective to the Purchaser/Dealer with Purchaser/Dealer being responsible for freight.

LIMITATIONS:

Neither KID Group, Inc. nor Dealer/Seller shall be liable for any incidental or consequential damages (including but not limited to, damages for injury to the person, property or lost turf, crops or profits) by reason of any defect in the equipment or its manufacture, design, or function.