

EL

News

Електролюкс
Electrolux
Macedonia
Palenzo

Evaporators and Condensers for Mobile A/C & Refrigeration

Karyer manufactures evaporators and condensers for Mobile Air-conditioners and Refrigeration according to customer requirements. We have numerous references in both Turkey and abroad on this subject. The calculations of the coils are made by using the UNILAB software, which is the most precise way to achieve the most efficient results.

For coils with 3/8" tube, Karyer has different dies with the dimensions of 25x12,5 mm, 25x19 mm, 25x21,65 mm, 25,4x22 mm, 30x26 mm and for coils with 7mm tube, dies with the dimensions of 19x16,5 mm are used. Upon request, for coils with 1/2" tube, dies with the dimensions of 31,75x27,5mm ve 40x35mm, for coils with 5/8" tube, dies with the dimensions of 40x35mm ve 50x50mm are suggested. For slim designs, inclined (30° and 60°) fin is available. Upon request, products can be coated with electrostatic powder dye.



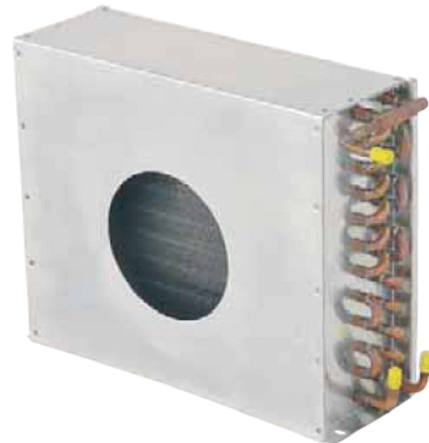
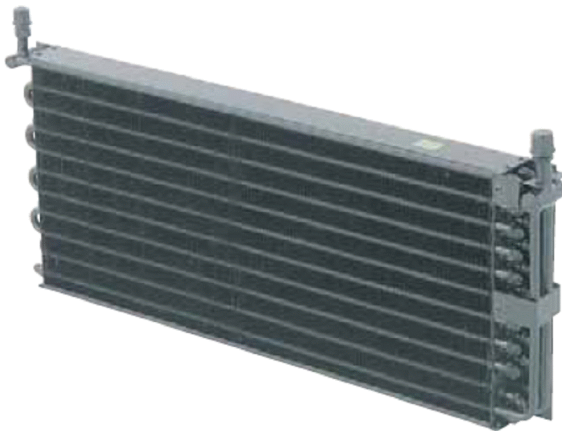
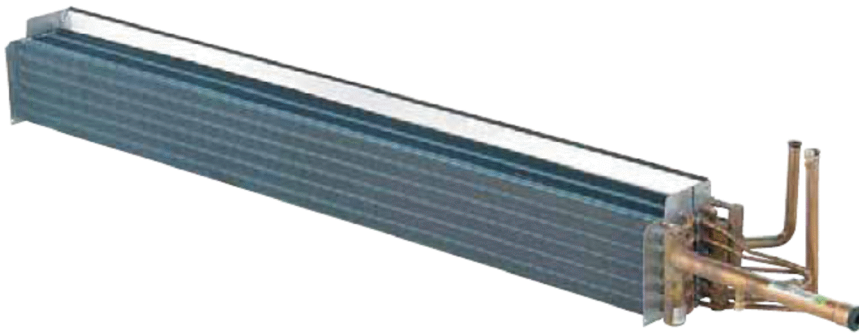

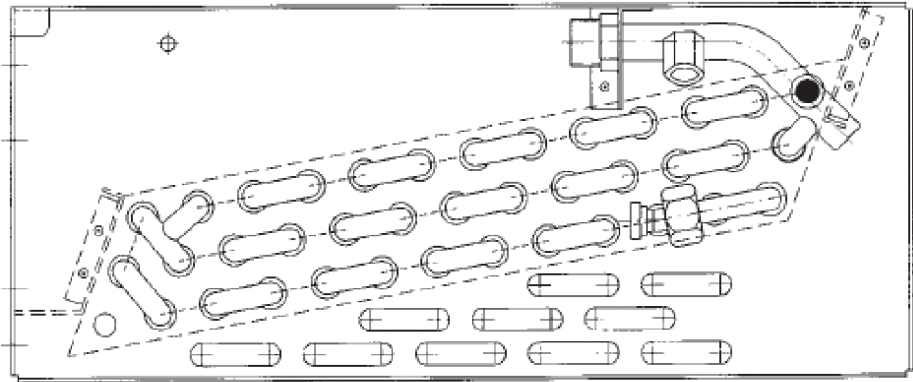
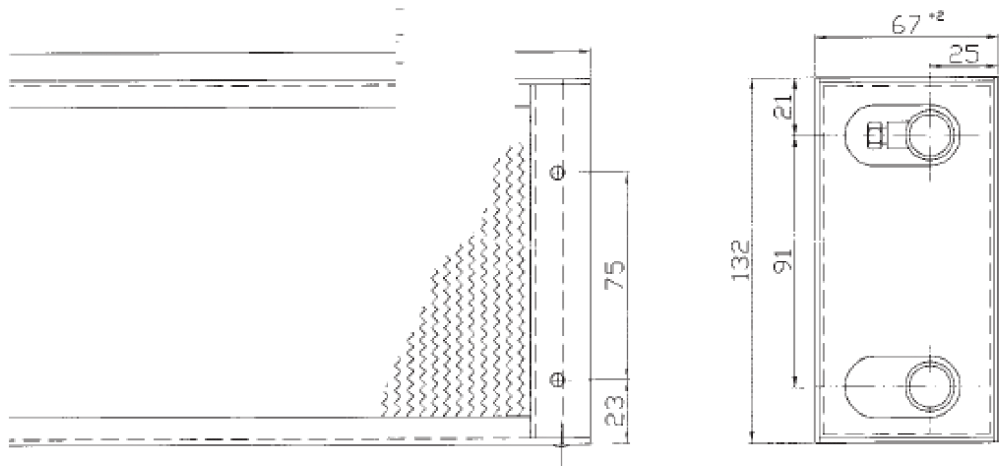

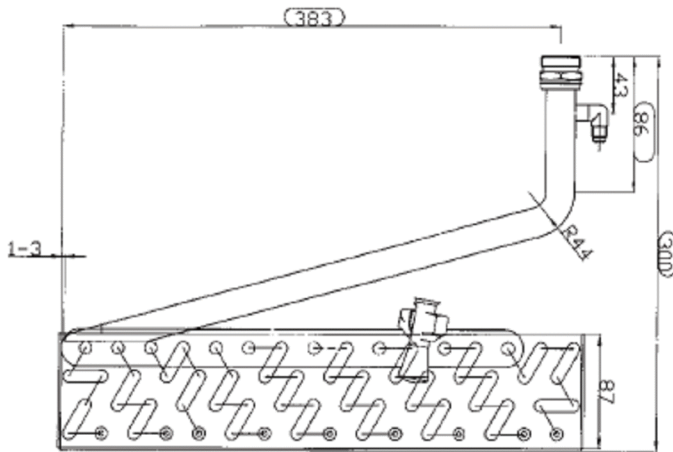
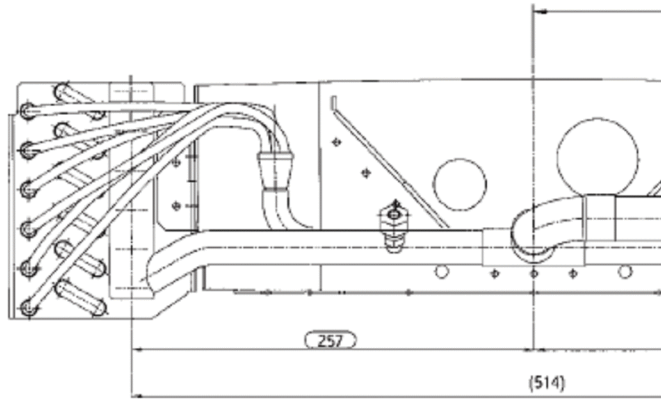

Kısıtlı yükseklikler için baklavalı (30° ve 60°) formda baskılar üretilmektedir.

For slim designs, inclined (30° and 60°) fin is available.

Für begrenzte Höhen werden Lamellen mit geneigter [30° und 60°] Form gestanzt.